

Catálogo
Catalogue
Catálogo

2023
2024

Iluminación
Lighting
Iluminação

ILUMINACIÓN LED PROFESIONAL
PROFESSIONAL LED LIGHTING
SOLUÇÕES PROFISSIONAIS DE LED

FILUX

ÍNDICE INDEX ÍNDICE

SKU

Índice de referencias SKU
SKU index
Índice de SKU

pag. 4

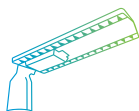

Farolas
Streetlights
Viárias

pag. 32



Regletas
Battens
Luminárias

pag. 54



Plafones led
Led ceiling lights
Luzes de teto led

pag. 74

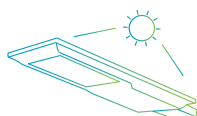

Luminaria solar
Solar luminaire
Luminária solar

pag. 98



Campanas
High bays
Campânulas

pag. 8



Luminárias estancas
Waterproof luminaires
Luminárias estanques

pag. 46



Paneles
Panels
Painéis

pag. 58



Sensores
Sensors
Sensores

pag. 84



Tiras
Strips
Fitas

pag. 102

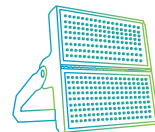

Proyectores
Floodlights
Projetores

pag. 20



Tubos
Tubes
Tubos

pag. 52



Downlights
Downlights
Downlights

pag. 66



Luminaria de emergencia
Emergency luminaire
Luminária de emergência

pag. 93



Bombillas
Bulbs
Lâmpadas

pag. 114

SOBRE NÓS

ABOUT US

SOBRE NOSOTROS

Fabricamos a medida
On demand custom
Fabricamos à medida

pag. 130

Situación geográfica
Geographic situation
Situação geográfica

pag. 131

Nuestros servicios
Our services
Serviços

pag. 132

Estudios lumínicos
Light tests
Estudos luminotécnicos

pag. 134

Certificaciones
Certifications
Certificações

pag. 135

Avance tecnológico
Technological advance
Avanço tecnológico

pag. 136

Ventajas de la iluminación led
Advantages of led lighting
Vantagens da iluminação led

pag. 137

Sé nuestro distribuidor
Be our distributor
Seja nosso distribuidor

pag. 138

Información catálogo
Catalogue info
Informação do catálogo

pag. 140

Terminología
Terminology
Terminologia

pag. 142

Temperatura de color
Color temperature
Temperatura de cor

pag. 144

Condiciones generales
General conditions
Condições gerais

pag. 145



REFERENCIAS SKU

F1010	FT-1007	2,34 €	p. 124	F1624	FT-3515	4,45 €	p. 119	F2129	FT-21030	16,94 €	p. 28
F1013	FT-1000	0,21 €	p. 53	F1625	FT-3515	4,45 €	p. 119	F2130	FT-21030	16,94 €	p. 28
F1040	FT-1009	5,98 €	p. 53	F1626	FT-1420	6,89 €	p. 123	F2131	FT-21050	25,11 €	p. 29
F1041	FT-1014	7,45 €	p. 53	F1627	FT-1420	6,89 €	p. 123	F2132	FT-21050	25,11 €	p. 29
F1042	FT-1018	8,41 €	p. 53	F1628	FT-1420	6,89 €	p. 123	F2133	FT-21050	25,11 €	p. 29
F1043	FT-1022	10,86 €	p. 53	F1632	FT-1608	2,71 €	p. 124	F2134	FT-21100	40,89 €	p. 29
F1139	FT-1120	34,56 €	p. 48	F1633	FT-1610	1,68 €	p. 118	F2135	FT-21100	40,89 €	p. 29
F1140	FT-1140	47,20 €	p. 48	F1634	FT-1610	1,68 €	p. 118	F2136	FT-21100	40,89 €	p. 29
F1141	FT-1150	58,34 €	p. 48	F1635	FT-1610	1,68 €	p. 118	F2137	FT-21150	79,25 €	p. 29
F1144	FT-1120	15,82 €	p. 49	F1636	FT-1612	2,04 €	p. 118	F2138	FT-21150	79,25 €	p. 29
F1145	FT-1140	24,67 €	p. 49	F1637	FT-1612	2,04 €	p. 118	F2139	FT-21150	79,25 €	p. 29
F1146	FT-1150	29,52 €	p. 49	F1638	FT-1612	2,04 €	p. 118	F2140	FT-21200	100,93 €	p. 29
F1147	FT-1104	5,99 €	p. 56	F1639	FT-1616	2,67 €	p. 118	F2141	FT-2140	18,32 €	p. 107
F1148	FT-1104	5,99 €	p. 56	F1640	FT-1616	2,67 €	p. 118	F2142	FT-2140	18,32 €	p. 107
F1149	FT-1108	7,02 €	p. 56	F1641	FT-1616	2,67 €	p. 118	F2143	FT-21200	100,93 €	p. 29
F1150	FT-1108	7,02 €	p. 56	F1704	FT-1704	1,54 €	p. 118	F2144	FT-21200	100,93 €	p. 29
F1151	FT-1116	9,66 €	p. 56	F1705	FT-1704	1,54 €	p. 122	F2145	FT-21250	134,28 €	p. 29
F1152	FT-1116	9,66 €	p. 56	F1706	FT-1704	1,54 €	p. 122	F2146	FT-21250	134,28 €	p. 29
F1504	FT-1504	1,49 €	p. 109	F1707	FT-1707	2,17 €	p. 122	F2147	FT-21250	134,28 €	p. 29
F1505	FT-1504	1,49 €	p. 109	F1708	FT-1707	2,17 €	p. 122	F2151	FT-2150	22,66 €	p. 57
F1506	FT-1504	1,49 €	p. 109	F1709	FT-1707	2,17 €	p. 122	F2152	FT-2150	22,66 €	p. 57
F1510	FT-1505	1,37 €	p. 119	F1807	FT-1807	2,33 €	p. 120	F2704	FT-2718	17,51 €	p. 126
F1511	FT-1505	1,37 €	p. 119	F1808	FT-1807	2,33 €	p. 120	F2814	FT-2802	13,47 €	p. 113
F1512	FT-1505	1,37 €	p. 119	F1809	FT-1807	2,33 €	p. 120	F2815	FT-2802	11,94 €	p. 113
F1513	FT-1507	2,33 €	p. 116	F1904	FT-1904	1,55 €	p. 121	F2816	FT-2802	11,07 €	p. 113
F1514	FT-1507	2,33 €	p. 116	F1905	FT-1904	1,55 €	p. 121	F2840	FT-2042	47,73 €	p. 105
F1515	FT-1507	2,33 €	p. 116	F1906	FT-1904	1,55 €	p. 121	F2841	FT-2042	47,73 €	p. 105
F1550	FT-1500	2,00 €	p. 128	F1907	FT-1907	2,02 €	p. 121	F2842	FT-2042	47,73 €	p. 105
F1551	FT-1500	2,05 €	p. 128	F1908	FT-1907	2,02 €	p. 121	F2843	FT-2122	73,50 €	p. 105
F1552	FT-1500	2,00 €	p. 128	F1909	FT-1907	2,02 €	p. 121	F2844	FT-2122	73,50 €	p. 105
F1553	FT-1500	2,05 €	p. 128	F2000	FT-2000	25,42 €	p. 31	F2845	FT-2122	73,50 €	p. 105
F1554	FT-1500	0,31 €	p. 128	F2054	FT-2000	3,16 €	p. 31	F2846	FT-2192	73,50 €	p. 105
F1555	FT-1500	5,51 €	p. 128	F2055	FT-2000	7,11 €	p. 31	F2847	FT-2192	73,50 €	p. 105
F1556	FT-1500	5,93 €	p. 128	F2053	FT-2000	0,57 €	p. 69	F2848	FT-2192	73,50 €	p. 105
F1557	FT-1500	6,29 €	p. 128	F2121	FT-2120	11,12 €	p. 57	F2849	FT-2046	60,01 €	p. 105
F1558	FT-1500	6,29 €	p. 128	F2122	FT-2120	11,12 €	p. 57	F2850	FT-2046	60,01 €	p. 105
F1601	FT-1605	1,47 €	p. 118	F2125	FT-21015	14,49 €	p. 28	F2851	FT-2046	60,01 €	p. 105
F1602	FT-1605	1,47 €	p. 118	F2126	FT-21015	14,49 €	p. 28	F2852	FT-2126	85,72 €	p. 105
F1603	FT-1605	1,47 €	p. 118	F2127	FT-21015	14,49 €	p. 28	F2853	FT-2126	85,72 €	p. 105
F1623	FT-3515	4,45 €	p. 119	F2128	FT-21030	16,94 €	p. 28	F2854	FT-2126	85,72 €	p. 105

*Ecoraee incluida | included | incluída * IVA no incluido | VAT not included | IVA não incluído

F2855	FT-2196	85,72 €	p. 105
F2856	FT-2196	85,72 €	p. 105
F2857	FT-2196	85,72 €	p. 105
F2858	FT-2815	14,44 €	p. 104
F2859	FT-2815	14,44 €	p. 104
F2860	FT-2815	14,44 €	p. 104
F2864	FT-2830	3,04 €	p. 104
F2865	FT-2804	8,25 €	p. 106
F2866	FT-2804	11,33 €	p. 106
F2867	FT-2804	14,84 €	p. 106
F2868	FT-2804	20,34 €	p. 106
F2869	FT-2804	21,89 €	p. 106
F2870	FT-2804	16,41 €	p. 106
F2871	FT-2804	25,00 €	p. 106
F2872	FT-2804	31,21 €	p. 106
F2873	FT-2804	42,42 €	p. 106
F2874	FT-2815	15,78 €	p. 104
F2875	FT-2830	70,14 €	p. 104
F2876	FT-2830	3,63 €	p. 104
F2878	FT-2801	39,42 €	p. 106
F2879	FT-2801	12,51 €	p. 106
F2880	FT-2801	22,53 €	p. 106
F2881	FT-2801	28,29 €	p. 106
F2882	FT-2801	28,93 €	p. 106
F2883	FT-2801	13,81 €	p. 107
F2884	FT-2801	8,75 €	p. 107
F2885	FT-2801	8,75 €	p. 108
F2886	FT-2801	10,03 €	p. 108
F2887	FT-2801	35,78 €	p. 109
F2888	FT-2801	25,69 €	p. 109
F2889	FT-2801	12,44 €	p. 110
F2890	FT-2801	17,55 €	p. 110
F2891	FT-2801	17,55 €	p. 111
F2892	FT-2801	28,79 €	p. 111
F2893	FT-2801	28,15 €	p. 112
F2894	FT-2801	50,70 €	p. 112
F2895	FT-2804	28,16 €	p. 106
F3012	FT-3000	105,00 €	p. 40
F30121	FT-3000	194,13 €	p. 40
F30122	FT-3000	194,13 €	p. 40
F30123	FT-3000	156,92 €	p. 40
F3013	FT-3000	10,29 €	p. 40
F3014	FT-3000	120,00 €	p. 40
F3015	FT-3000	14,51 €	p. 24
F3018	FT-3000	33,00 €	p. 24
F3305	FT-3350	41,57 €	p. 44
F3341	FT-33100	68,67 €	p. 34
F3342	FT-33100	101,38 €	p. 34
F3343	FT-33100	149,88 €	p. 34
F3344	FT-33100	78,59 €	p. 42
F3345	FT-33100	78,59 €	p. 42
F3346	FT-33100	14,84 €	p. 36
F3347	FT-33100	1,44 €	p. 36
F3348	FT-33100	125,87 €	p. 37
F3349	FT-33100	1.572,35 €	p. 37
F3350	FT-33100	2.508,90 €	p. 37
F3404	FT-3445	5,51 €	p. 41
F3411	FT-3420	16,59 €	p. 41
F3412	FT-3420	16,59 €	p. 41
F3413	FT-3420	16,59 €	p. 41
F3414	FT-3440	20,70 €	p. 41
F3415	FT-3440	20,70 €	p. 41
F3416	FT-3440	20,70 €	p. 41
F3701	FT-3725	1,90 €	p. 125
F3702	FT-3725	1,90 €	p. 125
F3703	FT-3725	1,90 €	p. 125
F3704	FT-3726	1,90 €	p. 125
F3705	FT-3726	1,90 €	p. 125
F3706	FT-3726	1,90 €	p. 125
F3813	FT-3811	7,24 €	p. 127
F3814	FT-3811	7,24 €	p. 127
F3815	FT-3811	9,75 €	p. 127
F3816	FT-3811	9,75 €	p. 127
F4722	FT-4720	206,01 €	p. 26
F4723	FT-4724	239,31 €	p. 26
F5101	FT-5106	12,49 €	p. 50
F5102	FT-5112	17,24 €	p. 50
F5103	FT-5115	20,40 €	p. 50
F5144	FT-5140	149,60 €	p. 38
F51441	FT-5140	228,39 €	p. 38
F51442	FT-5140	228,39 €	p. 38
F51443	FT-5140	191,58 €	p. 38
F5201	FT-5206	14,33 €	p. 50
F5202	FT-5212	20,27 €	p. 50
F5203	FT-5215	25,29 €	p. 50
F5244	FT-5240	200,38 €	p. 39
F5274	FT-5003	118,90 €	p. 101
F5276	FT-5003	200,24 €	p. 101
F5277	FT-5002	164,43 €	p. 100
F6010	FT-6000	26,57 €	p. 12
F6011	FT-6000	75,27 €	p. 12
F6018	FT-6100	158,55 €	p. 12
F6019	FT-6150	166,79 €	p. 12
F6020	FT-6200	209,12 €	p. 12
F6021	FT-6300	327,13 €	p. 10
F6027	FT-6000	9,71 €	p. 12
F6028	FT-6000	6,10 €	p. 12
F6029	FT-6000	6,10 €	p. 12
F6031	FT-6000	255,09 €	p. 12
F6032	FT-6000	31,36 €	p. 12
F6043	FT-6100	106,15 €	p. 14
F6044	FT-6150	116,56 €	p. 14
F6045	FT-6200	143,68 €	p. 14
F6046	FT-6000	9,71 €	p. 16
F6047	FT-6000	6,10 €	p. 28
F6048	FT-6000	6,10 €	p. 16
F6049	FT-6000	9,71 €	p. 16
F6050	FT-6000	6,10 €	p. 16
F6051	FT-6000	6,10 €	p. 16
F6060	FT-6200	87,57 €	p. 18
F6061	FT-6000	18,38 €	p. 19
F6513	FT-6000	48,39 €	p. 12
F7010	FT-7000	18,93 €	p. 94
F7011	FT-7000	3,01 €	p. 94
F7012	FT-7000	9,50 €	p. 94
F7013	FT-7000	32,34 €	p. 95
F7014	FT-7000	3,54 €	p. 95
F7015	FT-7000	2,68 €	p. 95
F7016	FT-7000	12,70 €	p. 95
F7017	FT-7000	0,48 €	p. 95

REFERENCIAS SKU

F7018	FT-7000	0,81 €	p. 95
F7019	FT-7000	108,06 €	p. 96
F7020	FT-7000	27,23 €	p. 96
F8007	FT-8000	14,73 €	p. 60
F8008	FT-8000	18,96 €	p. 61
F8009	FT-8000	6,90 €	p. 64
F8013	FT-8000	6,90 €	p. 65
F8014	FT-8000	21,95 €	p. 62
F8019	FT-8000	9,56 €	p. 63
F8030	FT-8000	16,11 €	p. 64
F8031	FT-8000	20,32 €	p. 65
F8032	FT-8000	8,06 €	p. 62
F8040	FT-8600	36,59 €	p. 63
F80401	FT-8600	46,86 €	p. 60
F80402	FT-8600	46,15 €	p. 60
F80403	FT-8600	61,82 €	p. 60
F8041	FT-8600	36,59 €	p. 63
F80411	FT-8600	46,86 €	p. 60
F80412	FT-8600	46,15 €	p. 60
F80413	FT-8600	61,82 €	p. 60
F80414	FT-8600	76,82 €	p. 60
F8042	FT-8123	44,18 €	p. 63
F80421	FT-8123	54,46 €	p. 61
F80422	FT-8123	53,74 €	p. 61
F80423	FT-8123	69,46 €	p. 61
F80424	FT-8123	84,46 €	p. 61
F8043	FT-8123	44,18 €	p. 63
F80431	FT-8123	54,46 €	p. 61
F80432	FT-8123	53,74 €	p. 61
F80433	FT-8123	69,46 €	p. 61
F80434	FT-8123	84,46 €	p. 61
F8044	FT-8126	92,41 €	p. 63
F80441	FT-8126	118,05 €	p. 62
F80443	FT-8126	147,30 €	p. 62
F8045	FT-8126	92,41 €	p. 63
F80451	FT-8126	118,05 €	p. 62
F80453	FT-8126	147,30 €	p. 62
F8046	FT-8000	10,28 €	p. 63
F8047	FT-8000	25,64 €	p. 63
F8050	FT-8600	23,29 €	p. 64
F8051	FT-8600	23,29 €	p. 64
F8052	FT-8123	26,23 €	p. 65
F8053	FT-8123	26,23 €	p. 65
F8511	FT-8500	93,06 €	p. 24
F8512	FT-8500	197,27 €	p. 24
F8513	FT-8500	248,78 €	p. 24
F8514	FT-8500	295,75 €	p. 24
F8515	FT-8500	22,30 €	p. 24
F8516	FT-8500	22,30 €	p. 24
F8517	FT-8500	22,30 €	p. 24
F8518	FT-8500	18,68 €	p. 25
F8519	FT-8500	65,56 €	p. 25
F8520	FT-8500	335,16 €	p. 24
F85201	FT-8500	450,52 €	p. 22
F85202	FT-8500	428,22 €	p. 22
F85203	FT-8500	450,52 €	p. 22
F85204	FT-8500	450,52 €	p. 22
F85205	FT-8500	912,18 €	p. 22
F85206	FT-8500	867,58 €	p. 22
F85207	FT-8500	912,18 €	p. 22
F85208	FT-8500	912,18 €	p. 22
F85209	FT-8500	1.321,15 €	p. 22
F85210	FT-8500	1.254,25 €	p. 22
F85211	FT-8500	1.321,15 €	p. 22
F85212	FT-8500	1.321,15 €	p. 22
F85213	FT-8500	1.725,57 €	p. 22
F85214	FT-8500	1.636,36 €	p. 22
F85215	FT-8500	1.725,57 €	p. 22
F85216	FT-8500	1.725,57 €	p. 22
F9061	FT-9001	2,98 €	p. 71
F9062	FT-9001	4,17 €	p. 71
F9063	FT-9001	5,05 €	p. 71
F9064	FT-9001	5,30 €	p. 71
F9065	FT-9001	3,06 €	p. 73
F9066	FT-9001	4,20 €	p. 73
F9067	FT-9001	5,42 €	p. 73
F9068	FT-9008	6,61 €	p. 70
F9069	FT-9015	9,24 €	p. 70
F9070	FT-9020	12,29 €	p. 70
F9071	FT-9025	14,73 €	p. 70
F9072	FT-9008	7,07 €	p. 72
F9073	FT-9015	9,77 €	p. 72
F9074	FT-9020	13,60 €	p. 72
F9075	FT-9005	9,34 €	p. 68
F9076	FT-9005	2,57 €	p. 69
F9077	FT-9005	2,13 €	p. 69
F9078	FT-9005	17,52 €	p. 68
F9079	FT-9005	3,60 €	p. 69
F9080	FT-9005	3,05 €	p. 69
F9086	FT-9015	12,99 €	p. 76
F9087	FT-9015	12,99 €	p. 76
F9088	FT-9015	12,99 €	p. 76
F9089	FT-9015	12,99 €	p. 76
F9090	FT-9015	13,33 €	p. 77
F9091	FT-9015	13,33 €	p. 77
F9092	FT-9015	13,33 €	p. 77
F9093	FT-9015	13,33 €	p. 77
F9094	FT-9015	14,95 €	p. 78
F9095	FT-9015	14,95 €	p. 78
F9096	FT-9015	9,12 €	p. 80
F9097	FT-9015	9,12 €	p. 81
F9098	FT-9015	34,30 €	p. 79
F9099	FT-9015	34,30 €	p. 79
F9201	FT-9210	10,13 €	p. 86
F9202	FT-9220	10,57 €	p. 87
F9203	FT-9230	20,92 €	p. 83
F9204	FT-9240	10,18 €	p. 88
F9205	FT-9240	10,18 €	p. 88
F9206	FT-9240	10,09 €	p. 89
F9207	FT-9240	10,38 €	p. 90
F9208	FT-9240	9,91 €	p. 91
F9209	FT-9240	9,54 €	p. 92
F9210	FT-9230	17,93 €	p. 82

*Ecorae incluida | included | incluída * IVA no incluido | VAT not included | IVA não incluído

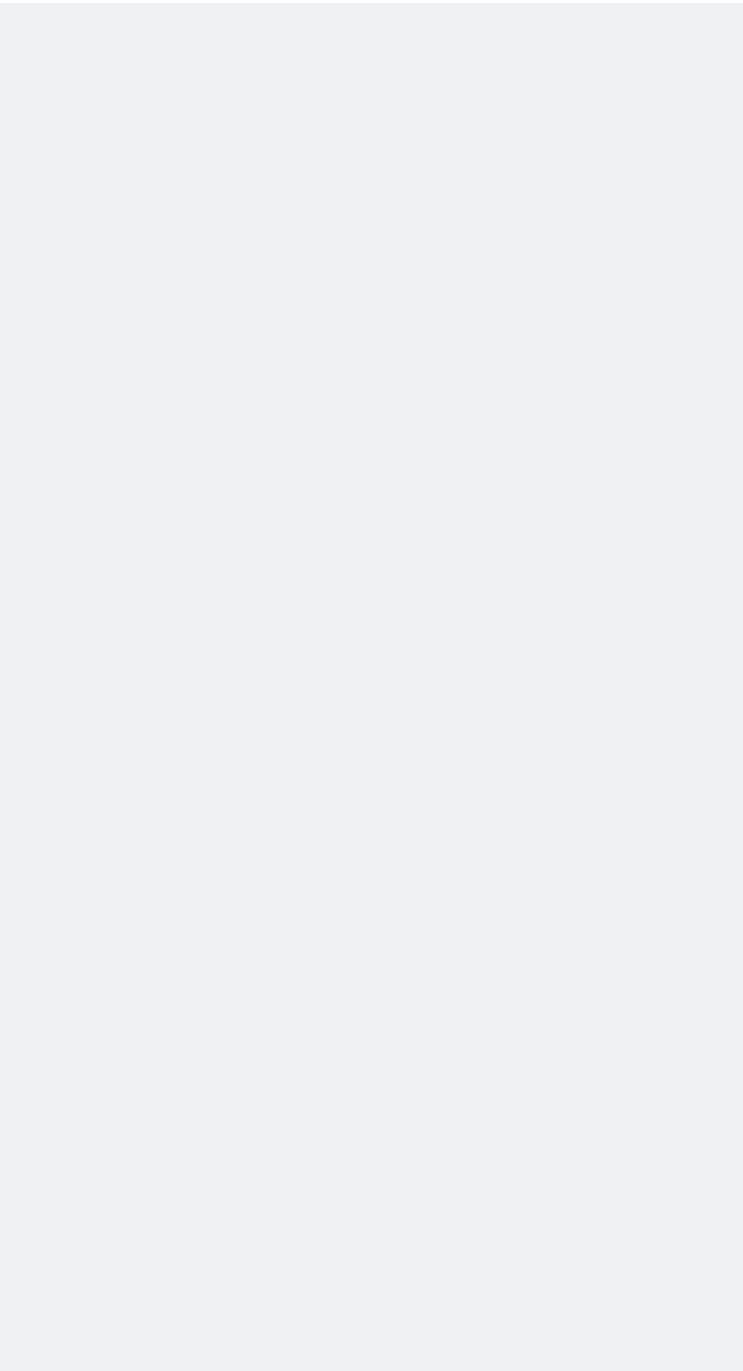

Produtos
Products
Productos





Campanas
High bays
Campânulas



LED PRO UFO HIGH BAY. Meanwell

La campana LED PRO UFO Filux cuenta con un diseño exclusivo y compacto que permite disipar el calor de forma constante y eficaz. Las Campanas LED PRO UFO Filux están fabricadas según los estándares de calidad más exigentes y ofrecen una garantía de 5 años. Las Campanas LED PRO UFO Filux presentan una gran resistencia.

Industrial LED PRO UFO high bays by Filux boasts a unique and compact design allowing to dissipate heat efficiently and constantly. LED PRO UFO Filux High bays are manufactured to the highest quality standards and offer a 5 year warranty. LED PRO UFO Filux High bays have a great resistance.

A campânula LED PRO UFO Filux tem um design exclusivo e compacto que dissipa o calor de maneira constante e eficaz. As campânulas LED PRO UFO Filux são fabricados atendendo aos mais altos padrões de qualidade e oferecem uma garantia de 5 anos. As câmpanulas Filux LED PRO UFO são muito resistentes.



- 5**
YEAR WARRANTY
- 50.000H**
- CRI**
>80
- 120°**
- MEANWELL**
- PF**
>0,95
- IP65**
- 4KV**
- IK09**
- LUMILEDS**
- 40° | +60°**
- 1 PCS**

Sku	Family	mm	Kg	Power	C.Temp	LM/W	Lumens	Input	Reg.	€*
-----	--------	----	----	-------	--------	------	--------	-------	------	----

A B

*Ecorae incluida | included | incluída
* IVA no incluido | VAT not included | IVA não incluído

F6018	FT-6100	191,40	Ø 320	4	100W	5.000K	160	100-240V, 50/60Hz	0-10V	16.000	158,55 €
F6019	FT-6150	193,88		4,3	150W					24000	166,79 €
F6020	FT-6200	198,50		4,4	200W					32.000	209,12 €
F6021	FT-6300	204,5	Ø 400	5	300W	150	45.000			327,13 €	

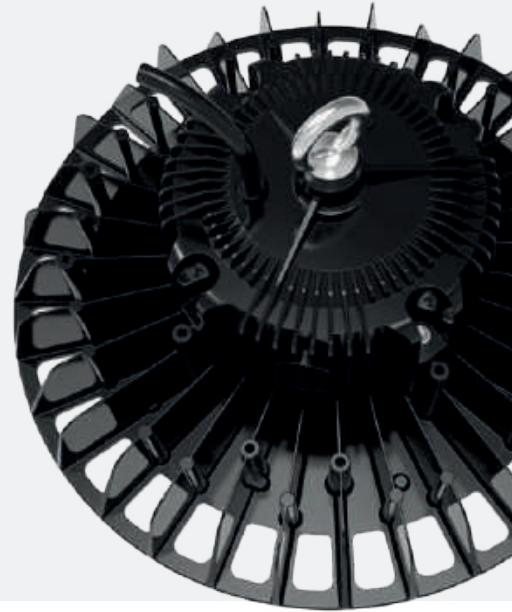

Fotometría | Photometry | Fotometria

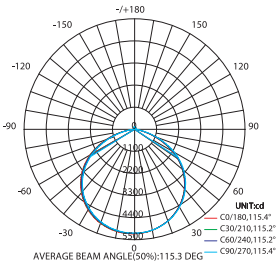

120°

Ángulo apertura
 Beam angle
 Ângulo de abertura

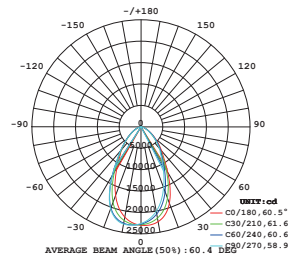

60°

Lente de ángulo apertura
 Beam angle lens
 Lente de Ângulo de abertura

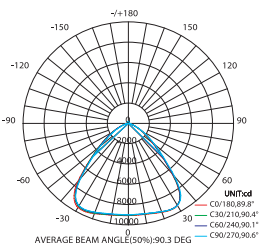

90°

Lente de ángulo apertura
 Beam angle lens
 Lente de ângulo de abertura

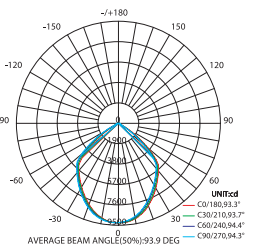

90° Ugr19 Ufo

Cubierta reflectora
 Reflective cover
 Capa reflectora

LED PRO UFO HIGH BAY. Meanwell

Accesorios | Accessories | Acessórios

*Ecoraee incluida | included | incluída

* IVA no incluido | VAT not included | IVA não incluído



FT-6000/F6011 | **75,27 €***

Kit base + sensor de movimiento
Base kit + motion sensor
Kit base + Sensor de movimento



FT-3000/F3015 | **14,51 €***

Protector sobre tensión Philips SP1
Philips voltage protector SP1
Protetor contra sobretensões Philips SP1



FT-6000/F6028 | **6,10 €***

Lente ángulo de apertura 60°
60° beam angle lens
Lente ângulo de abertura de 60°

Para/for:
F6018
F6019
F6020



FT-6000/F6029 | **6,10 €***

Lente ángulo de apertura 90°
90° beam angle lens
Lente ângulo de abertura de 90°

Para/for:
F6018
F6019
F6020



FT-6000/F6513 | **48,39 €***

Cubierta reflectora
Reflective cover
Cobertura reflectora (Pc 90° Ugr19 UFO)

Ø 480mm



FT-6000/F6027 | **9,71 €***

Soporte ajustable superficie
Surface adjustable support
Suporte superficie ajustável

Para/for:
F6018
F6019
F6020



FT-6000/F6032 | **31,36 €***

Convertor DALI - 1/10V
DALI converter - 1/10V
Convertor DALI - 1/10V



FT-2000/F2054 | **3,16 €***

Conector conexión rápida
Quick connect connector
Conector de ligação rápida

IP68



FT-2000/F2055 | **7,11 €***

T conexión rápida
T quick connection
Ligação rápida T



FT-6000/F6031 | **255,09 €***

Kit de emergencia
Emergency kit
Kit de emergência

Para/for:
F6018
F6019
F6020



FT-6000/F6010 | **26,57 €***

Kit base + sensor luz diurna
Base kit + daylight sensor
Kit base + sensor de luz

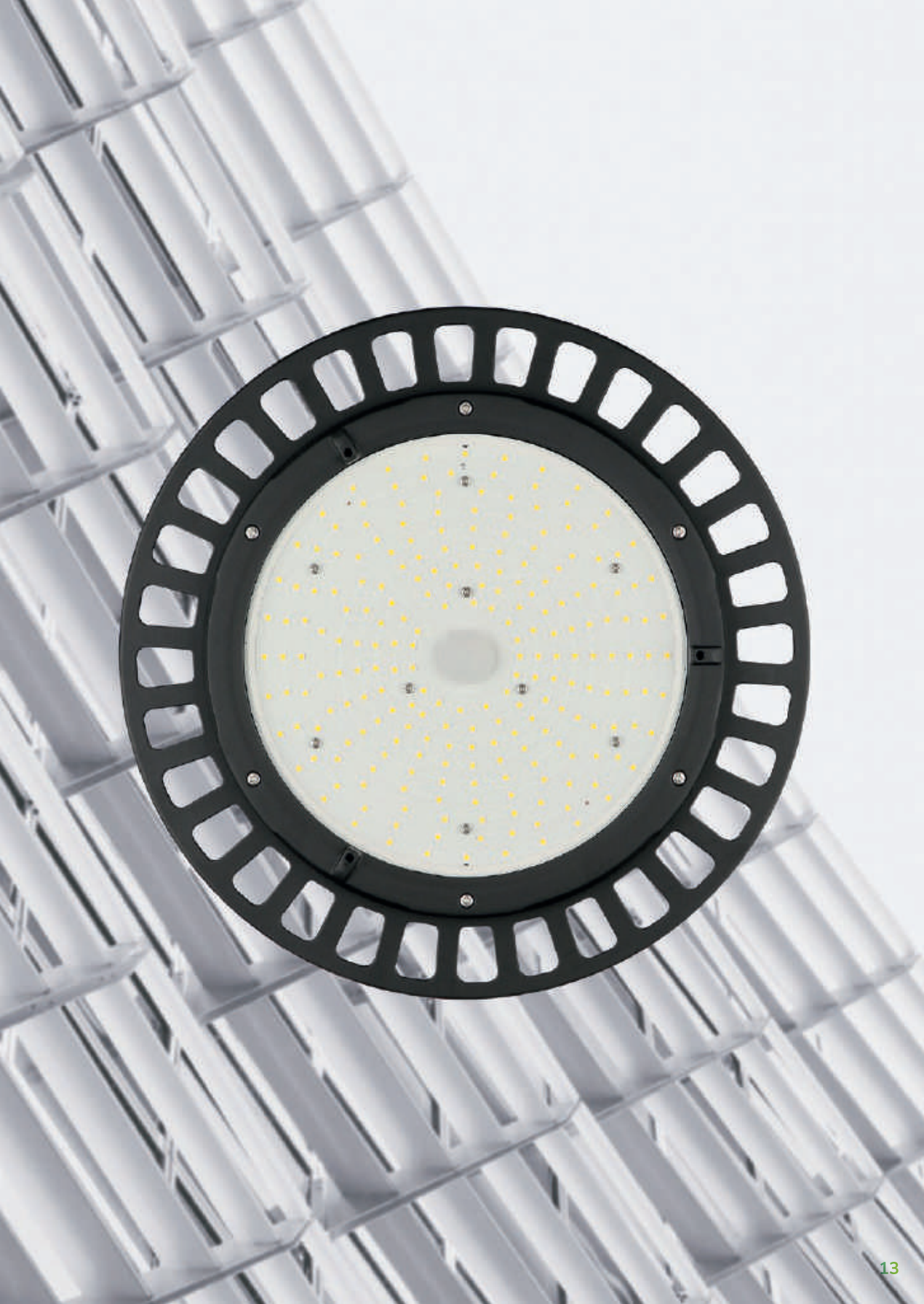

LED PRO UFO HIGH BAY. Philips

Las campanas LED PRO UFO Filux F6043, F6044, F6045 cuentan con Driver Philips y con un diseño exclusivo y compacto que permite disipar el calor de forma constante y eficaz. Las Campanas LED PRO UFO Filux están fabricadas según los estándares de calidad más exigentes y ofrecen una garantía de 5 años. Las Campanas LED Filux presentan una gran resistencia.

Industrial LED PRO UFO Filux F6043, F6044, F6045 high bays have a Philips driver and boasts a unique and compact design allowing to dissipate heat efficiently and constantly. LED PRO UFO Filux High bays are manufactured to the highest quality standards and offer a 5 year warranty. LED Filux High bays have a great resistance.

As câmpânulas LED PRO UFO Filux F6043, F6044, F6045 têm um driver Philips e possui um design exclusivo e compacto que dissipa o calor de maneira constante e eficaz. As câmpânulas LED PRO UFO Filux são fabricados atendendo aos mais altos padrões de qualidade e oferecem uma garantia de 5 anos. As câmpânulas Filux LED são muito resistentes.

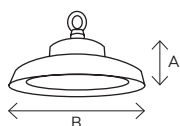

5
YEAR
WARRANTY

50.000H

CRI
>80

120°



PF
>0,95



IP65



4KV



IK08



LUMILEDS



-40° | +60°



1 PCS



Skü	Family	mm	Kg	Power	C.Temp	LM/W	Lumens	Input	Reg.	€*
		A	B							
F6043	FT-6100	184	Ø 310	2,2	100W	5.000K	16.000	220-240V, 50/60Hz	1-10V	106,15 €
F6044	FT-6150		Ø 310	2,3	150W		24.000			116,56 €
F6045	FT-6151	192	Ø 350	2,9	200W		32.000			143,68 €

*Ecorae incluída | included | incluída

* IVA no incluído | VAT not included | IVA não incluído

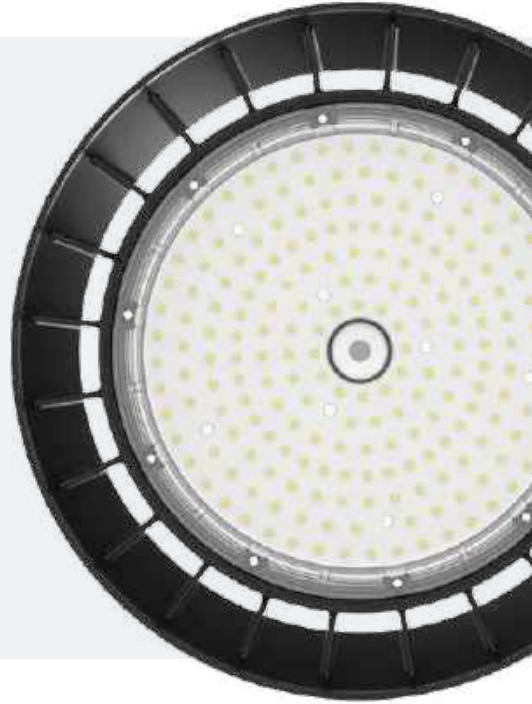

Fotometría | Photometry | Fotometria

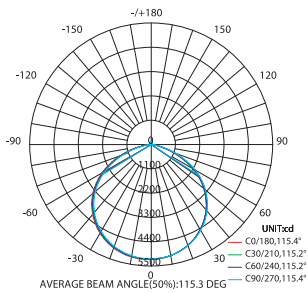

120°

Ángulo apertura
 Beam angle
 Ângulo de abertura

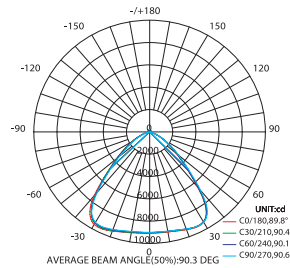

90°

Lente de ángulo apertura
 Beam angle lens
 Lente de Ângulo de abertura

LED PRO UFO HIGH BAY. Philips

Accesorios | Accessories | Acessórios

*Ecoraee incluída | included | incluída
* IVA no incluído | VAT not included | IVA não incluído

 FT-6000/F6010 26,57 €* 	 FT-6000/F6011 75,27 €* 	 FT-3000/F3015 14.51 €*
<p>Kit base + sensor luz diurna Base kit + daylight sensor Kit base + sensor de luz</p>	<p>Kit base + sensor de movimiento Base kit + motion sensor Kit base + Sensor de movimento</p>	<p>Protector sobre tensión Philips SP1 Philips voltage protector SP1 Protetor contra sobretensões Philips SP1</p>
 FT-2000/F2054 3,16 €* 	 FT-2000/F2055 7,11 €* 	 FT-6000/F6032 31,36 €*
<p>Conector conexión rápida Quick connect connector Conector de ligação rápida</p>	<p>T conexión rápida T quick connection Ligação rápida T</p>	<p>Convertor DALI - 1/10V DALI converter - 1/10V Convertor DALI - 1/10V</p>
 FT-6000/F6046 9,71 €* 	 FT-6000/F6047 6,10 €* 	 FT-6000/F6048 6,10 €*
<p>Soporte ajustable de superficie: F6043-44 Base kit + daylight sensor: F6043-44 Montagem superfície ajustável: F6043-44</p>	<p>Óptica 60° para UFO F6043-44 60° beam angle lens for F6043-44 Kit base + sensor de luz para: F6043-44</p>	<p>Óptica 90° para UFO F6043-44 90° beam angle lens for F6043-44 Lente ângulo de abertura 60°: F6043-44</p>
 FT-6000/F6049 9,71 €* 	 FT-6000/F6050 6,10 €* 	 FT-6000/F6051 6,10 €*
<p>Soporte ajustable de superficie: F6045 Base kit + daylight sensor: F6045 Montagem superfície ajustável: F6045</p>	<p>Óptica 60° para UFO F6045 60° beam angle lens for F6045 Kit base + sensor de luz para: F6045</p>	<p>Óptica 90° para UFO F6045 90° beam angle lens for F6045 Lente ângulo de abertura 60°: F6045</p>



LED VALUE UFO HIGH BAY

Las campanas LED PRO UFO Filux con un diseño exclusivo y compacto que permite disipar el calor de forma constante y eficaz, presentan una gran resistencia. Están fabricadas según los estándares de calidad más exigentes y ofrecen una garantía de 3 años.

The LED PRO UFO Filux hoods have a unique, compact design for constant and efficient heat dissipation and are highly resistant. They are manufactured to the highest quality standards and come with a 3-year guarantee.

As campânulas LED PRO UFO Filux têm um design único e compacto para uma dissipação de calor constante e eficaz e são altamente resistentes. São fabricados com os mais elevados padrões de qualidade e têm uma garantia de 3 anos.

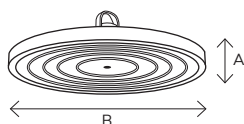

3
YEAR
WARRANTY

50.000H

CRI
>80

110°

PF
>0,95

IP65

SP
3KV

IK06

-25° | +45°

1 PCS



Con selector de cambio de potencia
With power selector switch
Com interruptor de seleção de potência



SKU	Family	mm	Kg	Power Selection	C.Temp	LM/W	Lumens	Input	€*	
		A	B							
F6060	FT-6200	94	Ø 381	2,2	100W	5.000K	155	15.500	220-240V 50/60Hz	87,57 €*
					150W		150	22.500		
					200W		140	28.000		

*Ecorae incluida | included | incluída
* IVA no incluido | VAT not included | IVA não incluído

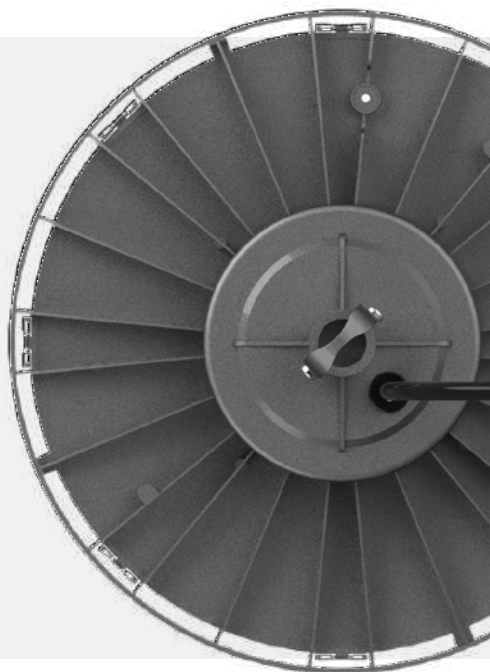

Accesorios | Accessories | Acessórios

*Ecoraee incluida | included | incluída
 * IVA no incluido | VAT not included | IVA não incluído



F6061 18,38 €*

Cubierta reflectora aluminio para F6060
 Aluminium reflector cover for F6060
 Cobertura reflectora em alumínio para F6060



FT-2000/F2054 3,16 €*

Conector conexión rápida
 Quick connect connector
 Conector de ligação rápida

IP68



FT-2000/F2055 7,11 €*

T conexión rápida
 T quick connection
 Ligação rápida T

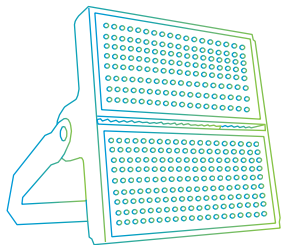

Proyectores

Floodlights

Projetores



LED PRO SPORT



SKU	Lens	€*	mm	kg	Lumens	C.Temp	Input
*Ecoraee incluida included incluída							
* IVA no incluido VAT not included IVA não incluído							
			A	B	C		
F85201	30°	450,52 €	230	420	110	5	42.000
F85202	45°	428,22 €					
F85203	60°	450,52 €					
F85204	90°	450,52 €					
F85205	30°	912,18 €	470	420	110	11	84.000
F85206	45°	867,58 €					
F85207	60°	912,18 €					
F85208	90°	912,18 €					
F85209	30°	1.321,15 €	720	420	110	16	126.000
F85210	45°	1.254,25 €					
F85211	60°	1.321,15 €					
F85212	90°	1.321,15 €					
F85213	30°	1.725,57 €	940	420	110	22	168.000
F85214	45°	1.636,36 €					
F85215	60°	1.725,57 €					
F85216	90°	1.725,57 €					
						5.000K	100-305V, 50/60Hz

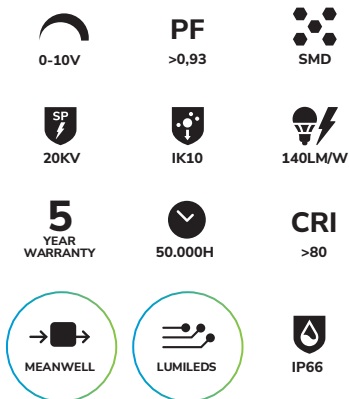

Producto desmontado necesita ensamblaje
 Disassembled product needs assembly
 Produto desmontado necessita de montagem



Es el sustituto perfecto para la sustitución de los focos en campos de fútbol, aeropuertos y puertos. Se puede inclinar para dirigir la luz en función de las necesidades del momento. El ángulo de apertura resulta muy adecuado como elemento de iluminación general.

It's the perfect substitute for the replacement of the floodlights in soccer stadiums, airports and ports. It can be tilted to direct the light according to the needs of the moment. The opening angle is very suitable as a general lighting element.

É a solução perfeita para utilização em campos de futebol, aeroportos e portos. Permite a orientação do feixe de luz. O ângulo de abertura é um elemento na iluminação geral.

Fotometrías | Photometries | Fotometrias

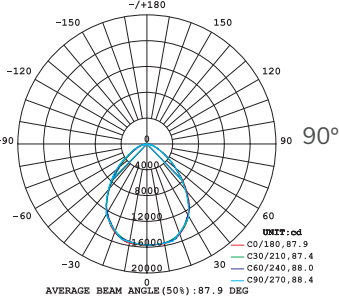
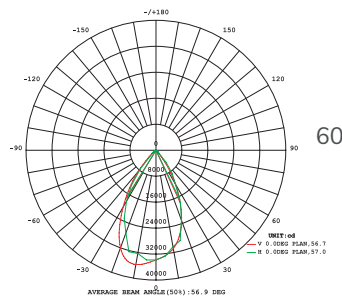
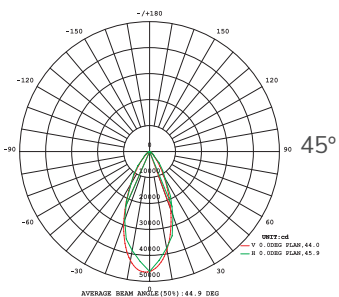
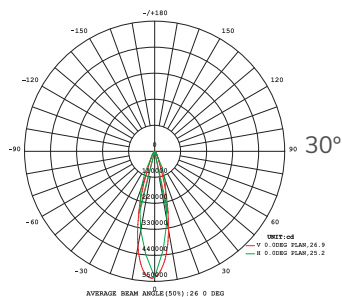

LED PRO SPORT

Componentes | Components | Componentes

*Ecorae incluida | included | incluída
 * IVA no incluido | VAT not included | IVA não incluído



FT-8500/F8515 **22,30 €***

Lente 30° para módulo 300W
 30° lens for module 300W
 Lente de 30° para módulo 300W



FT-8500/F8516 **22,30 €***

Lente 60° para módulo 300W
 60° lens for module 300W
 Lente de 60° para módulo 300W



FT-8500/F8517 **22,30 €***

Lente 90° para módulo 300W
 90° lens for module 300W
 Lente de 90° para módulo 300W



F8511 **93,06 €***

Soporte proyector deportivo 300W
 Support sport floodlight 300W
 Suporte projetor desportivo 300W



F8512 **197,27 €***

Soporte proyector deportivo 600W
 Support sport floodlight 600W
 Suporte projetor desportivo 600W



F8513 **248,78 €***

Soporte proyector deportivo 900W
 Support sport floodlight 900W
 Suporte projetor desportivo 900W



F8514 **295,75 €***

Soporte proyector deportivo 1200W
 Support sport floodlight 1200W
 Suporte projetor desportivo 1200W



F8520 **335,16 €***

Módulo 300W 45°
 Module 300W 45°
 Modulo 300W 45°

Accesorios | Accessories | Acessórios

*Ecorae incluida | included | incluída
 * IVA no incluido | VAT not included | IVA não incluído



FT-8500/F8518 **18,68 €***

Visera modular para módulo 300W
 Metallic reflector for module 300W
 Viseira modular para módulo 300W



FT-2000/F2054 **3,16 €***

Conector conexión rápida
 Quick connect connector
 Conector de ligação rápida

IP68



FT-2000/F2055 **7,11 €***

T conexión rápida
 T quick connection
 Ligação rápida T

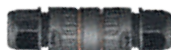

FT-6000/F6032 **31,36 €***

Conversor DALI - 1/10V
 DALI converter - 1/10V
 Conversor DALI - 1/10V



FT-8500/F8519 **65,56 €***

Sistema laser de replanteo iluminación
 Laser system for illumination stakeout
 Sistema laser para iluminação de piquetagem

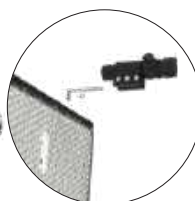

LED LINEAR LIGHT

Las Campanas Lineales LED Filux son el remplazo ideal de las tradicionales luminarias de vapor de sodio o mercurio de alta presión. Aporta un ahorro energético y permite reducir los costes de mantenimiento. No tienen elementos altamente contaminantes como el mercurio siendo totalmente ecológica.

The Filux LED Linear high bays are ideal replacement for traditional high pressure mercury or sodium vapor lamps. It provides energy savings and reduces maintenance costs. It does not have highly polluting elements like mercury being, totally ecological.

As câmpânulas lineares de LED Filux permitem a substituição ideal das luminárias tradicionais de vapor de sódio ou demercúrio de alta pressão. Permitem uma forte poupança de energia permitindo forte redução nos custos de manutenção. Não têm componentes altamente poluentes, tais como o mercúrio sendo totalmente ecológico.



5
YEAR
WARRANTY

50.000H

CRI
>80

90°X110°



PF
>0,9

0-10V



IP66



4KV



IK08



140LM/W



LUMILEDS



SMD



1 PCS



SKU	Family	mm			kg	Power	C.Temp	Lumens	Input	€*
		A	B	C						
F4722	FT-4720	685	153	136	5	200W	5.000K	28.000	100-277V 50/60HZ	206,01 €
F4723	FT-4724					240W		33.600		239,31 €

*Ecoraee incluida | included | incluída
* IVA no incluido | VAT not included | IVA não incluído

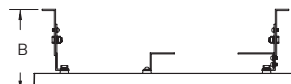
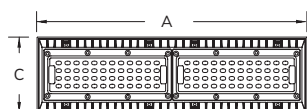



Conector F2054 incluido solo en modelo F4723
 Connector F2054 included only in model F4723
 Conector F2054 incluído apenas no modelo F4723

Fotometría | Photometry | Fotometria

90°x110°

Lente asimétrica

Lente de ángulo apertura
 Beam angle lens
 Lente de Ângulo de abertura

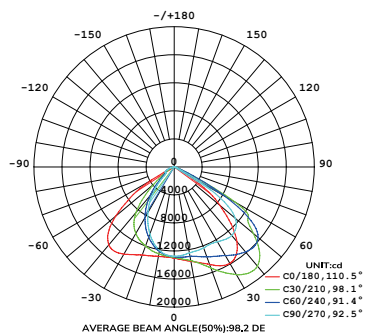

Accesorios | Accessories | Acessórios

*Ecoraee incluida | included | incluída
 * IVA no incluido | VAT not included | IVA não incluído



FT-6000/F6032

31,36 €*

Convertor DALI - 1/10V
 DALI converter - 1/10V
 Conversor DALI - 1/10V



FT-2000/F2054

3,16 €*

Conector conexión rápida
 Quick connect connector)
 Conector de ligação rápida

IP68



FT-2000/F2055

7,11 €*

T conexión rápida
 T quick connection
 Ligação rápida T

LED FLOODLIGHTS

Es el sustituto perfecto para los focos halógenos de exterior. Se puede inclinar para dirigir la luz en función de las necesidades del momento. La luz que emite es de alta calidad como indica su CRI. El ángulo de apertura resulta muy adecuado como elemento de iluminación general.

The perfect substitute for outdoor halogen spotlights. It can be tilted to direct the light according to the needs of the moment. The light it emits is of high quality as its CRI indicates. The opening angle is very suitable as a general lighting element.

É o substituto perfeito para holofotes de halogênio ao ar livre. Pode ser inclinado para direcionar a luz, dependendo da necessidades do momento. A luz que emite é alta qualidade como indicado pelo seu CRI. Os resultados do ângulo de abertura muito adequado como elemento de iluminação geral.

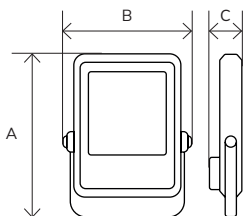

5
YEAR
WARRANTY

50,000H

CRI
>80

110°

IP65

PF
0,95

IK07

SMD

1m.
CABLE



SKU	Family	mm	kg	Power	C.Temp	Lumens	LM/W	Input	SP	Units p/pack	€*	
		A B C										
F2125	FT-21015	176	136	36	0,6	15W	3.000K	130	110-240V, 50/60Hz	2KV	12	14,49 €
F2126						4.000K						
F2127						5.700K						
F2128	FT-21030	176	136	36	0,6	30W	3.000K	130	110-240V, 50/60Hz	2KV	12	16,94 €
F2129						4.000K						
F2130						5.700K						

*Ecorae incluida | included | incluída
* IVA no incluido | VAT not included | IVA não incluído





Sku	Family	mm	kg	Power	C.Temp	Lumens	LM/W	Input	SP	Units p/pack	€*
-----	--------	----	----	-------	--------	--------	------	-------	----	--------------	----

A B C

**Ecoraee incluida | included | incluída
* IVA no incluido | VAT not included | IVA não incluído

Sku	Family	mm	kg	Power	C.Temp	Lumens	LM/W	Input	SP	Units p/pack	€*	
F2131	FT-21050	221,5	149	0,9	50W	3.000K	6.500	130	110-240V, 50/60Hz	4KV	12	25,11 €
F2132						4.000K						
F2133						5.700K						
F2134	FT-21100	264,5	208	1,5	100W	3.000K	13.000	130	110-240V, 50/60Hz	4KV	10	40,89 €
F2135						4.000K						
F2136						5.700K						
F2137	FT-21150	330	260	44	2,8	3.000K	19.500	130	110-240V, 50/60Hz	4KV	4	79,25 €
F2138						4.000K						
F2139						5.700K						
F2140	FT-21200	365	285	48	3,2	3.000K	26.000	130	110-240V, 50/60Hz	4KV	4	100,93 €
F2143						4.000K						
F2144						5.700K						
F2145	FT-21250	425	315	50	4,1	3.000K	32.500	130	110-240V, 50/60Hz	4KV	4	134,28 €
F2146						4.000K						
F2147						5.700K						

LED FLOODLIGHTS

Fotometrías | Photometries | Fotometrías

50W

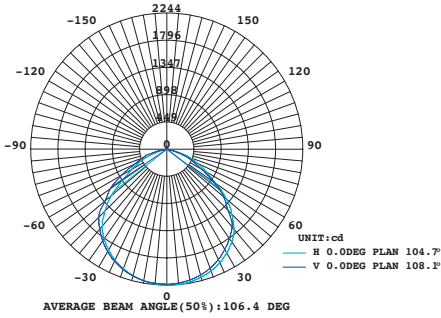

100W

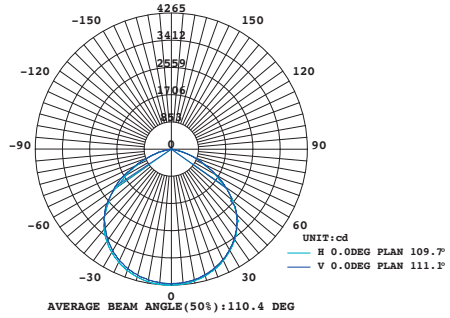

150W

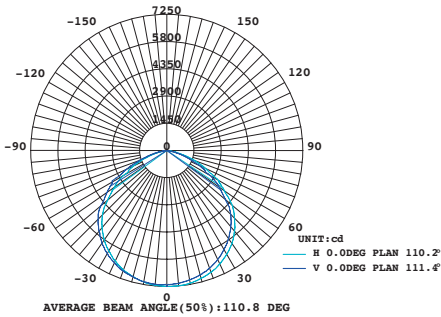

200W

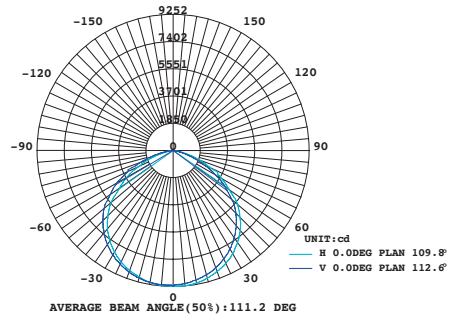

250W

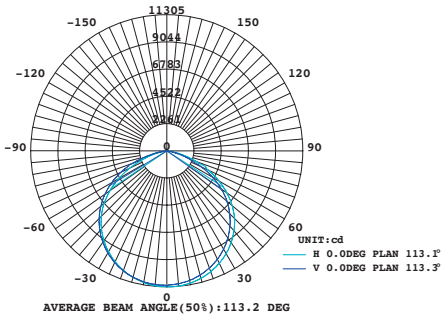

110° | Ángulo apertura
 Beam angle
 Ángulo de abertura

Accesorios | Accessories | Acessórios

*Ecoraee incluída | included | incluída
 * IVA no incluído | VAT not included | IVA não incluído



FT-2000/F2000

25,42 €*

Tripode para dos projectores
 Tripod for two projectors
 Tripé para dois projetores



FT-2000/F2054

3,16 €*

Conector conexión rápida
 Quick connect connector
 Conector de ligação rápida

IP68



FT-2000/F2055

7,11 €*

T conexión rápida
 T quick connection
 Ligação rápida T



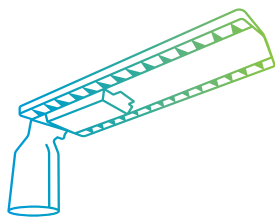

Farolas
Streetlights
Viárias



LED PRO STREETLIGHT.

Reemplazo perfecto para luces viales, con lentes de cristal ópticamente optimizados y cavidades ópticas selladas IP66. Uniformidad en la luz, máxima eficiencia y reduce las emisiones de CO2. Las Farolas LED PRO están fabricadas según los estándares de calidad más exigentes, presentan una gran resistencia a las condiciones meteorológicas extremas y ofrecen una garantía de 5 años.

Perfect replacement for road lights, with optically optimized glass lenses and IP66 sealed optical cavities. Uniformity in light, maximum efficiency and reduces CO2 emissions. The PRO LED Streetlights are manufactured according to the most demanding quality standards, have a great resistance to extreme weather conditions and offer a 5 year warranty.

Substituição perfeita para iluminação pública, com lentes de vidro ópticamente optimizadas e cavidades ópticas seladas IP66. Uniformidade de luz, máxima eficiência e redução de emissões de CO2. Os postes de iluminação LED PRO são fabricados de acordo com os mais exigentes padrões de qualidade, tendo grande resistência ás condições meteorológicas extremas e oferecem uma garantia de 5 anos.



5
YEAR
WARRANTY

50.000H

CRI
>80

TYPE II

PF
0,9

SMD

IP66

4KV

IK08

140LM/W



NEMA
Compatible



SKU	Model	mm			kg	Power	C.Temp	Lumens	Input	€*
-----	-------	----	--	--	----	-------	--------	--------	-------	----

A B C

*Ecoraee incluída | included | incluída
* IVA no incluído | VAT not included | IVA não incluído

F3341	FT-3330	117	424	Ø66	1,1	30W	4.000K	4.200	220-240V, 50/60Hz	68,67 €
F3342	FT-3360	155	494		1,5	60W		8.400		101,38 €
F3343	FT-33100	200	623		2,4	100W		14.000		149,88 €

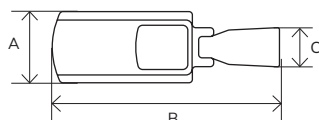

Fotometría | Photometry | Fotometria

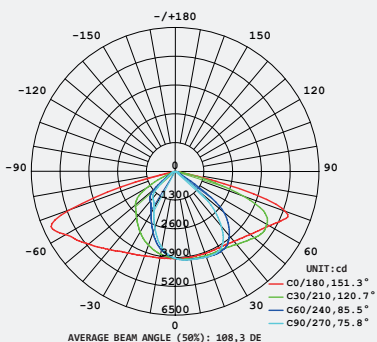

TYPE II

Ángulo apertura
Beam angle
Ângulo de abertura



Accesorios | Accessories | Acessórios

*Ecoraee incluida | included | incluída
*IVA no incluido | VAT not included | IVA não incluído



FT-2000/F2054

3,16 €*
IP68

Conector conexión rápida
Quick connect connector
Conector de ligação rápida



FT-2000/F2055

7,11 €*
Ligação rápida T

T conexión rápida
T quick connection
Ligação rápida T

LED PRO STREETLIGHT. ACCESORIES

*Ecorae incluida | included | incluída * IVA no incluido | VAT not included | IVA não incluído

STEP DIMMING CONTROLLER

FT-3000 F3346	Input voltage	AC85~265V, 50/60Hz	14,84 €*
	Output voltage	AC85~265V, 50/60Hz	
	Dimming	0-10V dimming	
	Max. Current	10A	
	Standby power consumption	<2W	
	Interface	STANDARD NEMA 5-PIN	
	IP Rating	IP66	



1. Modo de control de fotocélula (controlador de iluminación con interruptor de encendido/apagado automático):

Después de instalar la luminaria, en estado de encendido:

Si la fotocélula detecta una iluminancia ambiente < 20 lux (valor de configuración por defecto), encenderá la fuente de alimentación al controlador LED para que se encienda al 100%,

Si la fotocélula detecta la iluminancia ambiente > 200 lux (valor de configuración predeterminado), apagará la fuente de alimentación del controlador LED, haciendo que la lámpara entre en estado de espera.

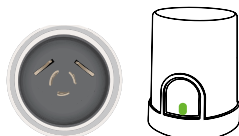

Preset timer task:

- Step 1: 3 Hours 100%
- Step 2: 2 Hours 80%
- Step 3: 4 Hours 60%
- Step 4: 4 Hours 80%

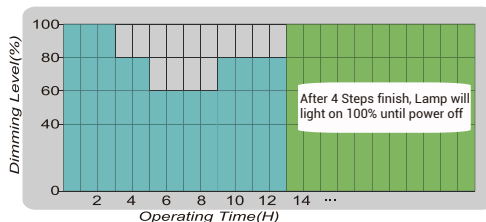

2. Modo de control de atenuación del temporizador de 4 pasos: (Modo preestablecido por fabricación)

Una vez instalada la luminaria, una vez **encendida***, el programa del temporizador comienza a cronometrar y ejecuta el paso 1, la lámpara se encenderá en el nivel de atenuación preestablecido (%) para tiempo de funcionamiento preestablecido (H).

Después del paso 1, cambie automáticamente al paso 2, 3, 4.

Una vez finalizados estos 4 pasos, el programa del temporizador finalizará y la lámpara volverá al 100 % luz encendida hasta que se **apague***

En cualquier estado, puede usar el panel de control remoto infrarrojo para configurar el tiempo de funcionamiento y la atenuación Nivel de los 4 escalones.

* **Encendido/apagado:** se puede encender/apagar manualmente en el gabinete de distribución de energía, o encender/apagar automáticamente mediante el control de la fotocélula

INFRARED REMOTE CONTROL PAD

Control distance >15m

FT-3000 F3347		Photocell control+4-Step timer dimming control	1,44 €*
		4-Step timer dimming control	
		Photocell control	
		Turn off the light	



CONTROLADOR ZIGBEE PARA TELEGESTIÓN

*Ecoraee incluida | included | incluída * IVA no incluido | VAT not included | IVA não incluído

FT-3000
F3348

Standard NEMA 5-PIN interface
Remotely turn ON/OFF, built-in 16A relay
Photocell auto control.
It supports dimming interface: DALI and 0-10V
It supports remote reading of electricity data: current, voltage, power, power factor and consumed energy
It supports recording total energy consumed and resetting
Lamp failure detection and automatic reporting to the server
Optional module: GPS, tilt and RTC

125,87 €*



ZIGBEE GATEWAY PARA TELEGESTIÓN

*Ecoraee incluida | included | incluída * IVA no incluido | VAT not included | IVA não incluído

FT-3000
F3349

96-264V AC input
Network indicator
Support GPRS/4G and Ethernet communication mode
Support Zigbee transmission (2.4G or 915M), MESH route
Power consumption, 2G&4G mode ≤ 30W.
Firmware upgrading: online or cable
Built-in RTC, support local scheduled task
Optional configuration: GPS
ll-in-one waterproof aluminum case

1.572,35 €*



ZIGBEE CONCENTRATOR PARA TELEGESTIÓN

*Ecoraee incluida | included | incluída * IVA no incluido | VAT not included | IVA não incluído

FT-3000
F3350

CD display
Micro-controller of high-performance 32-bit industrial-grade ARM9 CPU
Based on Linux system which is a highly reliable embedded platform.
With interface of 10/100M Ethernet, RS485, USB, etc
It supports GPRS & Ethernet remote communication methods
Upgrading locally/remotely: USB disk/Ethernet, GPRS
It is able to read electric energy remotely by built-in smart meters or external meters
Built-in 4 DO, 8 DI (6DC IN+2AC IN)
Fully sealed housing, strong anti-interference of high frequency signal ability and with standing high voltage, lightning

2.508,90 €*



STREETLIGHT HEAD ECA

Luminaria ECA LED PRO de alumbrado público y vial, de encendido instantáneo y gran potencia. Perfecto para sustituir las antiguas farolas de descarga, mejorando la calidad de la luz y reduciendo notablemente su consumo energético. Tiene una bisagra interior que mejora su estética y una óptica multiLED protegida con cristal templado.

ECA LED PRO luminaire for public lighting and road, instant on and great power. Perfect to replace old discharge lamps, improving the quality of light and significantly reducing energy consumption. It has an interior hinge that improves its aesthetic and a multiLED optic protected with tempered glass.

Luminária ECA LED PRO para iluminação pública, ignição instantânea e grande potência. Ideal para substituição de lâmpadas de descarga antigas, melhorando a qualidade da luz e reduzindo significativamente o consumo energético tem uma dobradiça interior que dá-lhe mais estética e uma ótica multiled protegida com vidro temperado.



SKU	Module	mm			kg	Power	C.Temp	Lumens	Input	€*
		A	B	C						
F51441	Luminaria Eca + Módulo Luminaire Eca + Module Luminária Eca + Módulo	F3344					3.000K	6.500	100-240V, 50/60Hz	228,39 €
F51442		F3345	180	Ø485	Ø60	3,4	50W			4.000K
F51443		F3350						4.000K		5.500

Detalles módulos LED en páginas 42, 43 y 44

Accesorios luminarias ECA | ECA luminaire accessories | Acessórios para luminárias ECA



FT-3000/F3015

14,51 €*

Protector sobre tensión Philips SP1
Philips voltage protector SP1
Protetor contra sobretensões Philips SP1



FT-2000/F2054

3,16 *

Conector conexión rápida
Quick connect connector
Conector de ligação rápida

IP68



FT-2000/F2055

7,11 €*

T conexión rápida
T quick connection
Ligação rápida T

*Ecorae incluida | included | incluída

* IVA no incluido | VAT not included | IVA não incluído

STREETLIGHT HEAD INVERTED ECA

Cuerpo para luminaria INVERTED ECA LED PRO de alumbrado público y vial, de encendido instantáneo y gran potencia. Perfecto para sustituir las antiguas farolas de descarga, mejorando la calidad de la luz y reduciendo notablemente su consumo energético. Tiene una bisagra interior que mejora su estética y una óptica multiLED protegida con cristal templado.

INVERTED ECA LED PRO luminaire for public lighting and road, instant on and great power. Perfect to replace old discharge lamps, improving the quality of light and significantly reducing energy consumption. It has an interior hinge that improves its aesthetic and a multiLED optic protected with tempered glass.

Luminária INVERTED ECA LED PRO para iluminação pública, ignição instantânea e grande potência. Ideal para substituição de lâmpadas de descarga antigas, melhorando a qualidade da luz e reduzindo significativamente o consumo enérgico tem uma dobradiça interior que dá-lhe mais estética e uma ótica multiled protegida com vidro temperado.

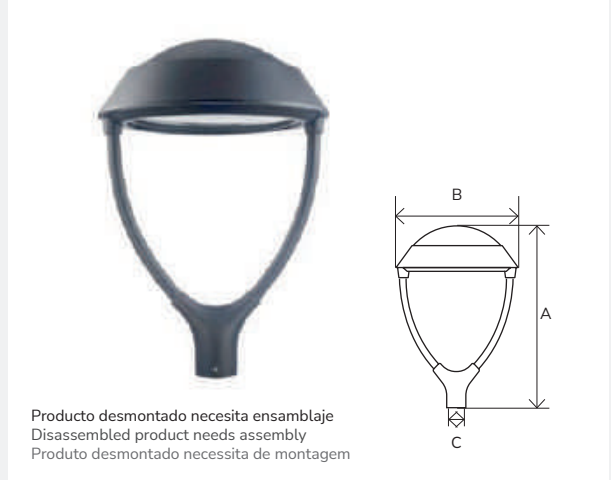

SKU	Module	mm	kg	Power	C.Temp	Lumens	Input	€*		
F52441	F3344	A	B	C						
F52442	F3345	681	Ø485	Ø60	4,3	50W	3.000K	6.500	100-240V, 50/60Hz	279,39 €
F52443	F3350						4.000K	5.500		279,39 €
							4.000K	5.500		242,40 €

Detalles módulos LED en páginas 42, 43 y 44

Componentes luminarias ECA | ECA luminaire components | Componentes de luminárias ECA



F5144 149,60 €*

Cuerpo Luminaria ECA
ECA luminaire body
Corpo da luminária ECA



F5244 200,38 €*

Cuerpo luminaria INVERTED ECA
INVERTED ECA luminaire body
Corpo da luminária ECA INVERTIDO

VILLA STREETLIGHT

La Luminaria Villa LED está fabricada en acero y presenta un diseño clásico y elegante, con un acabado en color negro. Es resistente a los rayos ultravioleta UV. Su fijación va directa a la columna o a un brazo mural con terminación en racor de 3/4".

The Villa LED luminaire is made of steel and features a classic and elegant design with a black finish. Resistant to ultraviolet UV rays. The fitting goes directly to the column or to a wall arm with a 3/4" fitting.

A luminária LED Villa é feita de aço e tem um design clássico e elegante, com um acabamento preto. É resistente aos raios ultravioleta UV. Sua fixação vai diretamente para a coluna ou para um braço de parede com um acabamento de 3/4".

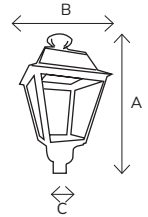

Producto desmontado necesita ensamblaje. Acero.
Disassembled product needs assembly. Steel.
Produto desmontado necessita de montagem. Aço.



Sku	Module	mm	mm			kg	Power	C.Temp	Lumens	Input	€*
			A	B	C						
F30121	Luminaria Villa + Módulo	F3344	780	395	60	6	50W	3.000K	6.500	100-240V, 50/60Hz	194,13 €
F30122	Luminaire Villa + Module	F3345						4.000K			194,13 €
F30123	Luminária Villa + Módulo	F3350						4.000K	5.500		156,92 €

Detalles módulos LED en páginas 42, 43 y 44

Accesorios | Accessories | Acessórios

*Ecoraee incluida | included | incluída
* IVA no incluido | VAT not included | IVA não incluído



FT-3000/F3018 **33,00 €***

Adaptador Farol Villa Punta 60mm
Lantern Adapter Villa Punta 60mm
Adaptador de lanterna Villa Punta 60mm

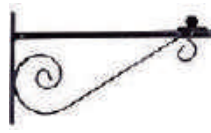

FT-3000/F3014 **120,00 €***

Brazo pared farola Villa
Villa streetlight wall arm
Braço poste de luz Villa
600mm



FT-3000/F3015 **14,51 €***

Protector sobre tensión Philips SP1
Philips voltage protector SP1
Protetor contra sobretensões Philips SP1

Componentes | Components | Componentes



FT-3000/F3012 **105,00 €***

Cabeczar Farol Villa
Villa Streetlight head
Cabeça de luminária Villa led



FT-3000/F3013 **10,29 €***

Adaptador módulo LED
LED module adapter
Adaptador de módulo LED

LED STREETLIGHT BULB

Bombilla de radiación IR no UV. Encendido instantáneo del 100%. Baja salida térmica. Perfecta para sustituir lámparas incandescentes convencionales en áreas comerciales, zonas urbanas y con una larga vida útil. Solo apto para funcionamiento vertical.

Non-UV IR radiation bulb. Instant ignition of 100%. Low thermal output. Perfect to replace conventional incandescent lamps in commercial areas, urban areas and with a long service life. Suitable for vertical operation only.

Lâmpada sem radiação ir e UV. Ignição instantânea 100%. Baixa emissão térmica. Ideal para substituir lâmpadas incandescentes convencionais em locais comerciais, espaços urbanos e com uma longa vida útil.



Solo apto para funcionamiento vertical.
Suitable for vertical operation only.
Apenas para utilização vertical

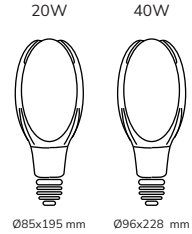

2
YEAR
WARRANTY

25.000H

CRI
>80

330°

IP20

SP
1KV

E27

PF
>0,9

SMD

20 PCS

SKU	Family	Power	C.Temp	LM/W	Lumens	Input	€*
-----	--------	-------	--------	------	--------	-------	----

Ecoraee incluida | included | incluída
* IVA no incluido | VAT not included | IVA não incluído

F3411	FT-3420	20W	3.000K	130	2.600	220-240V, 50Hz	16,59 €
F3412			4.000K				
F3413			6.500K				
F3414	FT-3440	40W	3.000K		5.200		20,70 €
F3415			4.000K				
F3416			6.500K				

Fotometría | Photometry | Fotometria

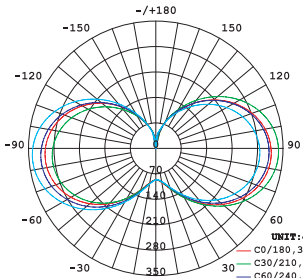

330°

Ángulo apertura
Beam angle
Ângulo de abertura

UNIT: cd
 - C0/180, 335.7
 - C30/210, 336.7
 - C60/240, 338.5
 - C90/270, 339.9
 AVERAGE BEAM ANGLE (50%): 337.7 DEG

Accesorios | Accessories | Acessórios

*Ecoraee incluida | included | incluída
* IVA no incluido | VAT not included | IVA não incluído



FT-3445/F3404

5,51 €*

Adaptador conversor E40-E27
E40-E20 converter adapter
Adaptador conversor E40-E20

LED MODULE 130 L/W. Bridgelux LED

El módulo LED de Filux está fabricado según los estándares de calidad más exigentes y ofrece una garantía de 5 años. Presenta una gran resistencia a las condiciones meteorológicas extremas.

Filux's LED module is manufactured to the highest quality standards and offers a 5-year warranty. It is highly resistant to extreme weather conditions.

O módulo LED Filux é fabricado de acordo com os mais elevados padrões de qualidade oferecendo uma garantia de 5 anos. É bastante resistente a condições climáticas adversas.

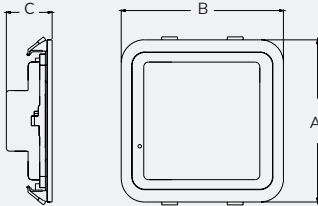

5
YEAR
WARRANTY

50.000H

CRI
>80

TYPE II

PF
>0,9

STEP DIMMING
REGULATION

IP66

4KV

IK08

130LM/W



10 PCS



SKU	Family	mm			kg	Power	C.Temp	Lumens	Input	€*
		A	B	C						
F3344	FT-3350	210	59,30	1,5	50W	3.000K	6.500	100-240V, 50/60Hz	78,59 €	
F3345						4.000K				

*Ecoraee incluida | included | inclusa
* IVA no incluido | VAT not included | IVA não incluído

Fotometría | Photometry | Fotometria

TYPE II | Ángulo apertura
Beam angle
Ângulo de abertura

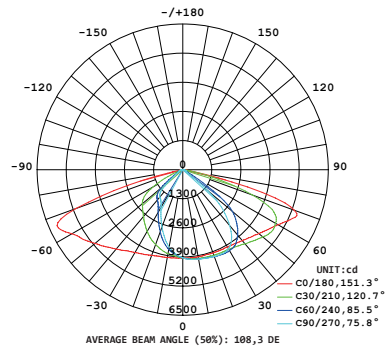

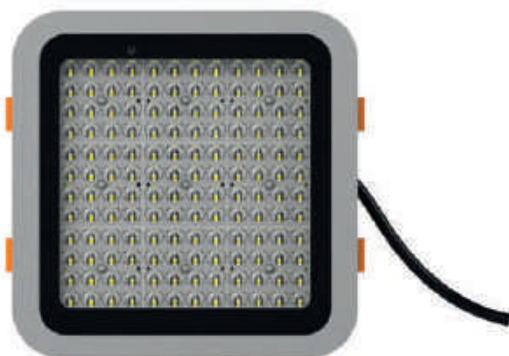

Accesorios | Accessories | Acessórios

*Ecorae incluida | included | incluída
 * IVA no incluido | VAT not included | IVA não incluído



FT-3000/F3015

14,51 €*

Protector sobre tensión Philips SP1
 Philips voltage protector SP1
 Protetor contra sobretensões Philips SP1



FT-2000/F2054

3,16 €*

Conector conexión rápida
 Quick connect connector
 Conector de ligação rápida

IP68



FT-2000/F2055

7,11 €*

T conexión rápida
 T quick connection
 Ligação rápida T

LED MODULE 110 L/W

Los módulos LED Filux están fabricados según los estándares de calidad más exigentes y ofrecen una garantía de 3 años. Presentan una gran resistencia a las condiciones meteorológicas extremas.

Filux LED modules are manufactured to the highest quality standards and offer a 3 year warranty. They are highly resistant to extreme weather conditions.

Os módulos LED Filux são fabricados com os elevados padrões de qualidade oferecendo uma garantia de 3 anos. Têm grande resistência às condições climáticas extremas.

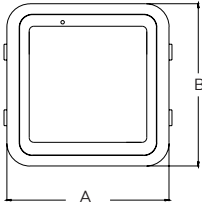
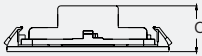

3
YEAR
WARRANTY

50.000H

CRI
>80

TYPE II

PF
>0,9

IP66

4KV

IK08

110LM/W

10 PCS

SMD



SKU	Family	mm			kg	Power	C.Temp	Lumens	Input	€*
		A	B	C						
F3305	FT-3350	210	59,30	1,5	50W	4.000K	5.500	100-240V, 50/60Hz	41,57 €	

*Ecorae incluida | included | incluída

* IVA no incluido | VAT not included | IVA não incluído

Fotometría | Photometry | Fotometria

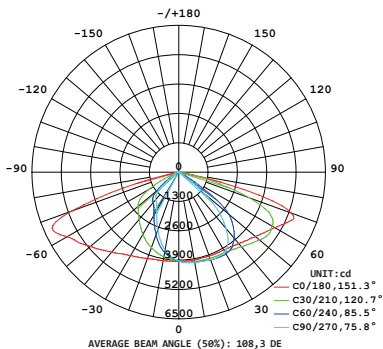

TYPE II | Ángulo apertura
Beam angle
Ângulo de abertura

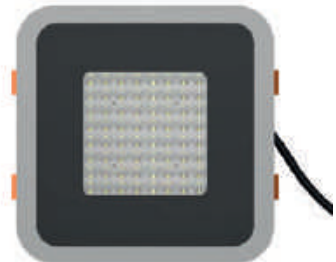



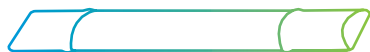

Luminarias estancas
Waterproof luminaires
Luminárias estanques



LUMINARIAS ESTANCAS | WATERPROOF LUMINAIRES | LUMINÁRIAS ESTANQUES

LED PRO TRI-PROOF LIGHT FITTING

Las pantallas Estanca LED de Filux F1140 y F1141 cuentan con driver Osram y chips Bridgelux. Su aplicación se extiende a cualquier espacio amplio, tanto interior como exterior y la instalación se realiza sin tener que modificar el cableado. Están fabricadas en materiales polimeros que aseguran su perdurabilidad en el tiempo. Cuentan con conexión 2 laterales (potencia máxima conectable: 300W).

Filux Waterproof LED tri-proof F1140 and F1141 have Osram driver and Bridgelux chips. Its application extends to any ample space, both interior and exterior ensure and the installation is done without having to modify the wiring. They are made of polymer materials that ensure their durability over time. 2 side connection (maximum power linkable: 300W).

As armaduras estanques LED Filux F1140 e F1141 têm driver Osram e chips Bridgelux. Sua aplicação é muito vast, podendo ser instalada em espaços interiores ou exteriores e a instalação é feita sem necessidade de modificar a cablagem. As armaduras são fabricadas em materiais poliméricos que garantem a sua durabilidade no tempo. Com 2 conexões laterais (potência máxima conectável: 300W).

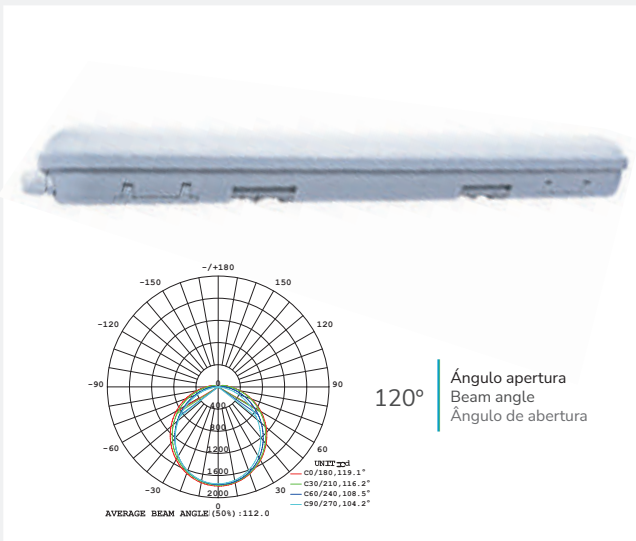

5
YEAR
WARRANTY

50.000H

CRI
>80

120°

PF
>0,9

OSRAM

IP65

IK08

125LM/W

bridgelux

6 PCS



SKU	Family	mm			kg	Power	C.Temp	Lumens	Input	€*
		A	B	C	*Ecoraee incluída included incluída * IVA no incluído VAT not included IVA não incluído					
F1139	FT-1120	605	70	96	0,75	20W	5.000K	2.500	220-240V, 50/60Hz	34,56 €
F1140	FT-1140	1.210	71	71	0,8	40W		5.000		47,20 €
F1141	FT-1150	1.510			1,6	60W		7.500		58,34 €

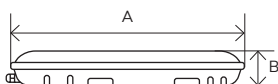

Conexión 2 laterales | 2 side connection | 2 ligações laterais

Max. potencia conectable 300W
Max. power linkable 300W
Potencia conectável max. 300W

LED BATTEN IP65

Las pantallas Estancas LED de Filux consiguen que la instalación se realice sin tener que modificar el cableado. Su aplicación se extiende a cualquier espacio amplio, tanto interior como exterior. Todas las pantallas para tubos LED son estancas y cuentan con un diseño que facilita su montaje. Están fabricadas en materiales poliméricos que aseguran su perdurabilidad en el tiempo.

Filux Waterproof LED tri-proof ensure that the installation is done without having to modify the wiring. Its application extends to any ample space, both interior and exterior. All screens for LED tubes are watertight and have a design that facilitates their assembly. They are made of polymer materials that ensure their durability over time.

As armaduras estanques LED Filux permitem que a sua instalação se faça sem modificar a cablagem. Sua aplicação é muito vast, podendo ser instalada em espaços interiores ou exteriores. As armaduras são fabricadas em materiais poliméricos que garantem a sua durabilidade no tempo.

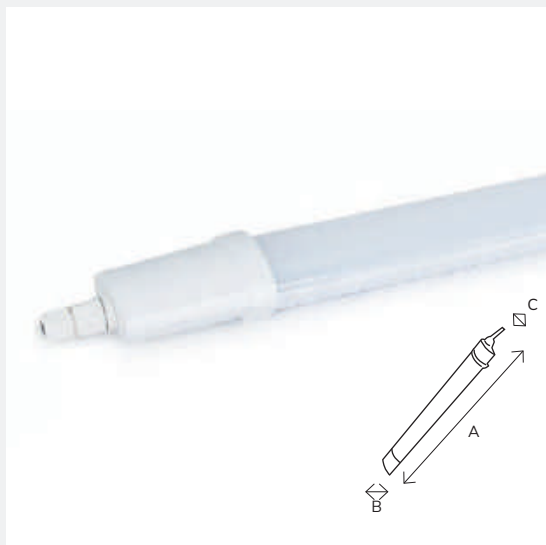

2
YEAR
WARRANTY

20.000H

CRI
>80

110°

IP65

IK06

SMD



SKU	Family	mm		kg	Power	C.Temp	Lumens	Input	SP	Units p/pack	€*
		A	B	C							
F1144	FT-1120	600			0,23	18W	1.620		>0,5	40	15,82 €
F1145	FT-1140	1.200	64	40	0,45	36W	3.240	AC230V	>0,9	20	24,67 €
F1146	FT-1150	1.500			0,60	45W	4.050				29,52 €

*Ecorae incluida | included | incluída
* IVA no incluido | VAT not included | IVA não incluído

Fotometría | Photometrie | Fotometria

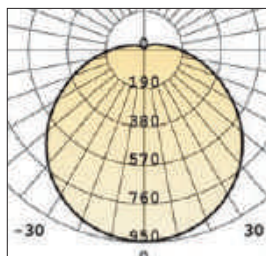

110°

Ángulo apertura
Beam angle
Ângulo de abertura

WATERPROOF FITTINGS



Sku	Family	mm			kg	Descripción Description Descrição	€*
		A	B	C			
F5101	FT-5106	600	68	70	0,51	Pantalla Estanca IP65 600 mm para 1 tubo Waterproof Fitting IP65 600 mm for 1 tube Armadura Estanque IP65 de 600 mm para 1 tubo	12,49 €
F5102	FT-5112	1200			0,924	Pantalla Estanca IP65 1.200 mm para 1 tubo Waterproof Fitting IP65 1.200 mm for 1 tube Armadura Estanque IP65 de 1.200 mm para 1 tubo	17,24 €
F5103	FT-5115	1500			1,14	Pantalla Estanca IP65 1.500 mm para 1 tubo Waterproof Fitting IP65 1.500 mm for 1 tube Armadura Estanque IP65 de 1.500 mm para 1 tubo	20,40 €
F5201	FT-5206	600	103	103	0,662	Pantalla Estanca IP65 600 mm para 2 tubos Waterproof Fitting IP65 600 mm for 2 tubes Armadura Estanque IP65 de 600 mm para 2 tubos	14,33 €
F5202	FT-5212	1200			1,248	Pantalla Estanca IP65 1.200 mm para 2 tubos Waterproof Fitting IP65 1.200 mm for 2 tubes Armadura Estanque IP65 de 1.200 mm para 2 tubos	20,27 €
F5203	FT-5215	1500			1,546	Pantalla Estanca IP65 1.500 mm para 2 tubos Waterproof Fitting IP65 1.500 mm for 2 tubes Armadura Estanque IP65 de 1.500 mm para 2 tubos	25,29 €

*Ecorae incluida | included | incluída
* IVA no incluído | VAT not included | IVA não incluído





Tubos

Tubes

Tubos



T8 LED TUBES

Las lámparas de tubo T8 LED de Filux son de vidrio con cubierta de plástico anti rotura. Disponemos de diferentes modelos con distintas temperaturas de color, entre los que destacamos el blanco neutro, el blanco frío o el blanco cálido. Estas lámparas de tubo LED cuentan con un sistema de encendido instantáneo y aguantan temperaturas de (-20° a 45°).

Filux T8 LED tubes are made of glass with an anti-breakage plastic cover. We have different models with different color temperatures, among them we highlight the ones with neutral white, cold white or warm white. These LED tube lamps feature an instantaneous ignition system and withstand temperatures of (-20° to 45°).

Os tubos LED Filux T8 são feitos de vidro com uma tampa de plástico anti-quebra. Temos diferentes modelos com diferentes temperaturas de cor, entre os quais o branco neutro, o branco frio ou o branco quente. Estas lâmpadas de tubo LED têm um sistema de ignição e retenção instantâneas (-20° a 45°).

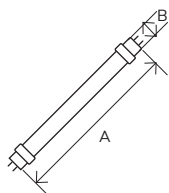

5
YEAR
WARRANTY

50.000H

CRI
80

300°

PF
>0,9



IP20



130LM/W



G13



25 PCS



SMD



24H
POWER



Model	SKU	mm	g	Power	Colour selector	Lumens	Input	€*	
		A	B	*Ecoraee incluida included incluída * IVA no incluido VAT not included IVA não incluído					
FT-1009	F1040	600	Ø 28	100,9	9W	3.000K 4.000K 6.500K	1.170	220-240V, 50-60Hz	5,98 €
FT-1014	F1041	900		147,6	16W	3.000K 4.000K 6.500K	2.080		7,45 €
FT-1018	F1042	1200		191,1	18W	3.000K 4.000K 6.500K	2.340		8,41 €
FT-1022	F1043	1500		234,5	24W	3.000K 4.000K 6.500K	3.120		10,86 €

Accesorios | Accessories | Acessórios



FT-1000	F1013	Sustituto cebador	0,21 €*
---------	-------	-------------------	---------



Regletas
Battens
Luminárias

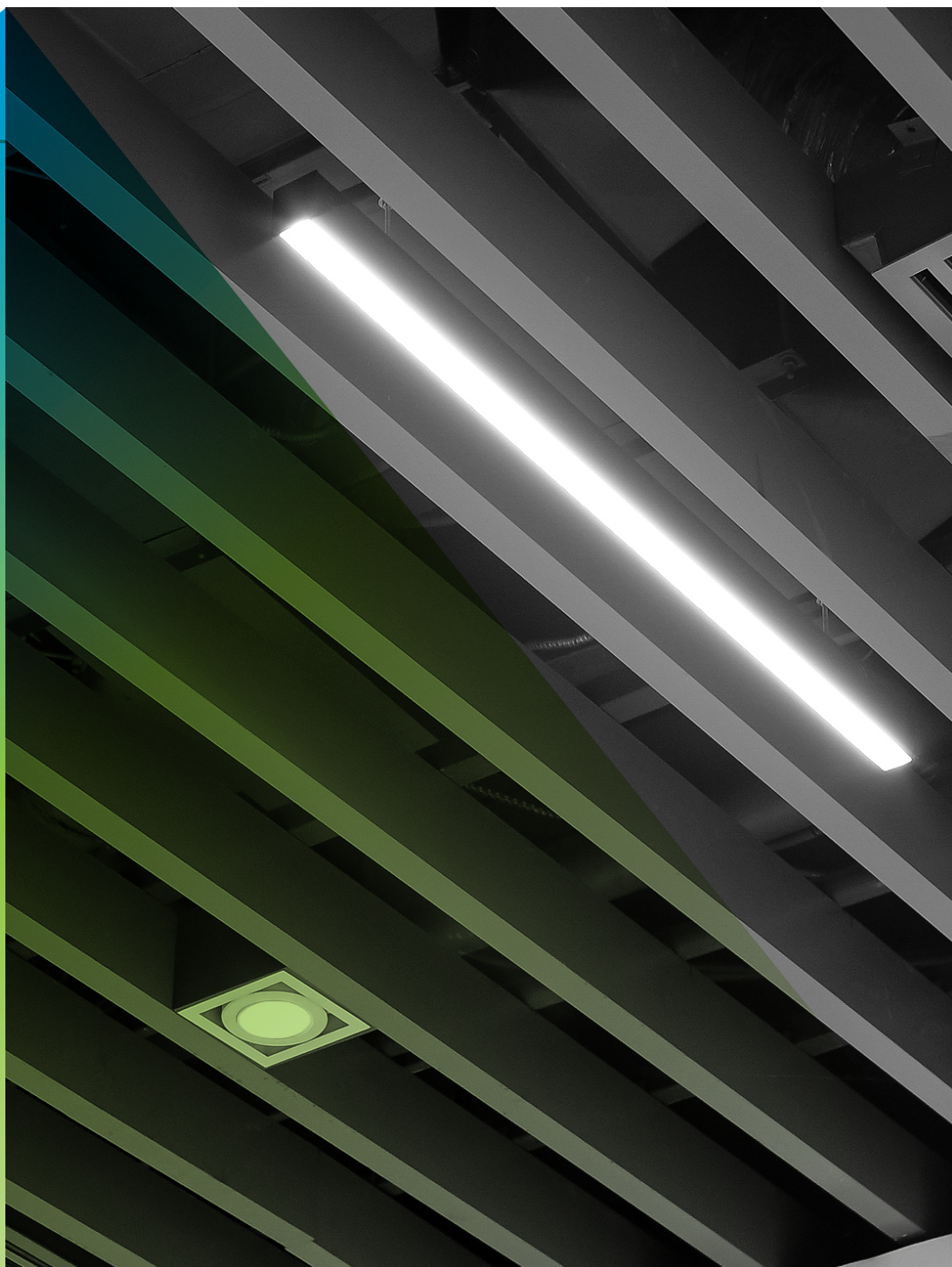

T5 BATTEN WITH SWITCH

La barra lineal T5 de Filux con interruptor incorporado puede conectarse una a una y un interruptor puede controlar hasta 10 lámparas. Diferentes modelos pueden conectar hasta 8 lámparas. La corriente máxima permitida de lámparas es 0,8A.

Filux T5 linear bar with built-in switch can be connected one by one and one switch can control up to 10 lamps. Different models can connect up to 8 lamps. The maximum allowed current of lamps is 0.8A.

A barra linear Filux T5 com interruptor embudido pode ser conectada uma a uma e uma chave pode controlar até 10 lâmpadas. Diferentes modelos podem conectar até 8 lâmpadas. A corrente máxima permitida das lâmpadas é 0,8A.



Model	SKU	mm			kg	Power	C.Temp	Lumens	Input	Units p/pack	€*
		A	B	C							
FT-1104	F1147	272	22	36	0,20	4W	4.000K	320	220-240V, 50/60Hz	40	5,99 €
	6500K										
FT-1108	F1149	572	22	36	0,28	8W	4.000K	640	220-240V, 50/60Hz	40	7,02 €
	6.500K										
FT-1116	F1151	1.172	22	36	0,36	16W	4.000K	1.280	220-240V, 50/60Hz	30	9,66 €
	F1152						6.500K				

*Ecorae incluida | included | incluida
* IVA no incluido | VAT not included | IVA não incluído

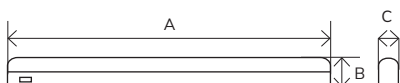

Conexión 2 laterales | 2 side connection | 2 ligações laterais
Max. potencia conectable 175W | Max. power linkable 175W | Potencia conectável max. 175W

LED SUPER SLIM IP20

Los plafones super slim LED de Filux son un sustituto perfecto para las pantallas de tubos fluorescentes tradicionales. Los plafones super Slim de Filux están hechos en aluminio + plástico y son ideales para oficinas, hoteles, concesionarios, centros comerciales, supermercados, almacenes, parkings.

The Filux LED super slim ceiling lamps are a perfect substitute for traditional fluorescent tube displays. The Filux super slim panels are made of aluminum + plastic and are ideal for offices, hotels, dealers, malls, supermarkets, warehouses, car parks.

Os painéis LED super slim da Filux são o substituto perfeito para armaduras de tubos fluorescentes tradicionais os painéis filux super slim são feito em alumínio + plástico são ideais para escritórios, hotéis, concessionários, centros comerciais, supermercados, armazéns, estacionamento.

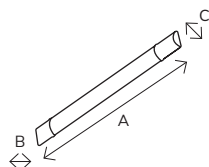
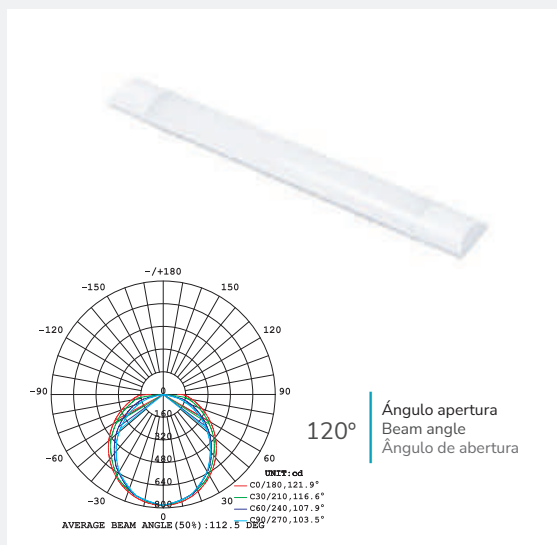

2
YEAR
WARRANTY

25.000H

CRI
>80

120°

PF
>0,9



SKU	Family	mm			kg	Power	C.Temp	Lumens	Input	€*
		A	B	C						
F2121	FT-2120	600	75	22	0,20	20W	4.000K	1.700-1.800	220-240V, 50Hz	11,12 €
F2122							6.000K			
F2141	FT-2140	1.200	75	22	0,28	40W	4.000K	3.500-3.600	220-240V, 50Hz	18,32 €
F2142							6.000K			
F2151	FT-2150	1.500	75	22	0,36	50W	4.000K	4.200-4.500	220-240V, 50Hz	22,66 €
F2152							6.000K			

*Ecoraee incluída | included | incluída
 * IVA no incluido | VAT not included | IVA não incluído



Paneles

Panels

Painéis



LED PANEL 600X600

Los paneles UGR LED PRO, brindan una luz ideal para oficinas, tiendas, hoteles, hospitales, escuelas e institutos. Aportando un mayor confort visual con su difusor que asegura una salida luminosa homogénea, asegurando en todos los puntos el factor de deslumbramiento UGR<19.

UGR LED PRO panels provide an ideal light for offices, shops, hotels, hospitals, schools and institutes. Providing greater visual comfort with its diffuser that ensures a homogenous light output, ensuring at all points the glare factor UGR <19.

Os painéis UGR LED PRO fornecem uma luz ideal para escritórios, lojas, hotéis, hospitais, escolas e institutos. Proporcionando maior conforto visual com seu difusor que garante uma saída de luz homogênea, garantindo em todos os pontos o fator de brilho UGR <19.



5
YEAR
WARRANTY

50.000H

CRI
>80

110°

PF
>0,9

IP20

110LM/W

UGR
<19

SMD

6 PCS



Sku	Family	mm	kg	Power	Driver	Reg.	C.Temp	Lumens	Input	€*			
		A	B	C									
F80401	FT-8600	595	595	8	2,1			44W	4.840	220-240V, 50/60Hz	46,86 €		
F80411								Philips				6.000K	
F80402								Lifud				4.000K	
F80412								Lifud				6.000K	
F80403							0-10v	4.400	40W		Lifud	4.000K	61,82 €
F80413						Lifud			6.000K				
F80404						Lifud			4.000K				
F80414						Lifud			6.000K		76,82 €		

*Ecorae incluida | included | incluída

* IVA no incluido | VAT not included | IVA não incluído

Accesorios | Accessories | Acessórios

*Ecorae incluida | included | incluída

* IVA no incluido | VAT not included | IVA não incluído



FT-8000/F8007

14,73 €*

Kit de superficie para panel 600x600
Surface kit for 600x600 panel
Kit de superfície para panel 600x600



FT-8000/F8009

6,90 €*

Kit de suspensión para panel 600x600
Suspension kit for 600x600 panel
Kit de suspensão para painel 600x600



FT-8000/F8030

16,11 €*

Marco para empotrar para panel 600x600
Recessed frame for 600x600 panel
Moldura de encastrar para painel 600x600

LED PRO PANEL 1200X300

Los paneles LED PRO de Filux te permitirán crear un ambiente muy luminoso y actual por su diseño integrado y elegante. La duración de los paneles LED es mucho mayor que la de los paneles convencionales, por eso es una elección recomendada si buscamos un sistema lumínico para nuestra estancia.

The Filux LED PRO panels will allow you to create a very bright and contemporary environment due to its integrated and elegant design. The length of LED panels is much longer than conventional panels.

Os painéis LED PRO 5 anos de garantia Filux, permitem criar um ambiente muito brilhante e moderno devido ao seu design integrado e elegante. A sua aplicação é ampla e variada. A duração dos painéis de LED é maior do que os painéis convencionais.

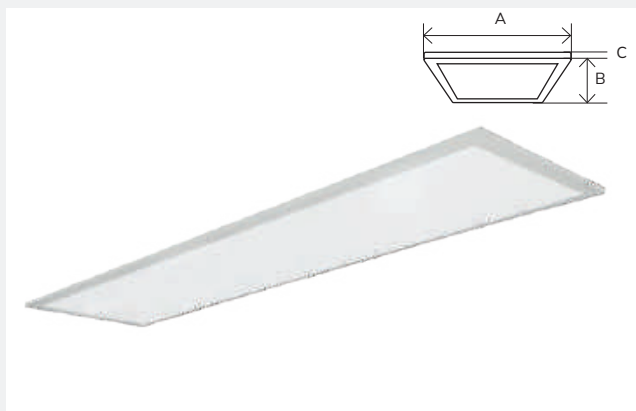

5
YEAR
WARRANTY

50.000H

CRI
>80

110°

PF
>0,9

IP20

110LM/W

UGR
<19

SMD

4 PCS



Model	SKU	mm			kg	Power	Driver	Reg.	C.Temp	Lumens	Input	€*
		A	B	C								
FT-8123	F80421	1195	295	8	2,5	44W	Philips		4.000K	4.840	220-240V, 50/60Hz	54,46 €
	F80431						Philips					
	F80422					30W	Lifud	4.000K	3.300	53,74 €		
	F80432						Lifud					6.000K
	F80423					40W	Lifud	4.000K	4.400	69,46 €		
	F80433						Lifud					6.000K
	F80424						Lifud	4.000K		DALI2		84,46 €
	F80434						Lifud					

*Ecoraee incluida | included | incluída

* IVA no incluido | VAT not included | IVA não incluído

Accesorios | Accessories | Acessórios

*Ecoraee incluida | included | incluída

* IVA no incluido | VAT not included | IVA não incluído



FT-8000/F8008 18,96 €*

Kit de superficie para panel 1.200X300
Surface kit for 1.200X300 panel
Kit de superficie para painel 1.200X300



FT-8000/F8013 6,90 €*

Kit de suspensión para panel 1.200X300
Suspension kit for 1.200X300 panel
Kit de suspensão para painel 1.200X300



FT-8000/F8031 20,32 €*

Marco para empotrar para panel 1.200x300
Recessed frame for 1.200x300 panel
Moldura de encastrar para painel 1.200x300

LED PANEL 1200X600

Los paneles LED PRO de Filux te permitirán crear un ambiente muy luminoso y actual por su diseño integrado y elegante. La duración de los paneles LED es mucho mayor que la de los paneles convencionales, por eso es una elección recomendada si buscamos un sistema lumínico para nuestra estancia.

The Filux LED PRO panels will allow you to create a very bright and contemporary environment due to its integrated and elegant design. The length of LED panels is much longer than conventional panels.

Os painéis LED PRO 5 anos de garantia Filux, permitem criar um ambiente muito brilhante e moderno devido ao seu design integrado e elegante. A sua aplicação é ampla e variada. A duração dos painéis de LED é maior do que os painéis convencionais.



5
YEAR
WARRANTY

50.000H

CRI
>80

110°

PF
>0,9

IP20

110LM/W

UGR
<19

SMD

4 PCS



Model	SKU	mm	kg	Power	Driver	Reg.	C.Temp	Lumens	Input	€*		
		A	B	C								
FT-8126	F80441	1195	595	8	2,5	60W	Philips	-	4.000K	6.600	220-240V, 50/60Hz	118,05 €
	Philips						-	6.000K				
	Lifud						DALI2 0-10V	4.000K	147,30 €			
	Lifud						0-10V	6.000K				

Accesorios | Accessories | Acessórios



FT-8000/F8014 **21,95 €***

Kit de superficie para panel 1.200x600
Surface kit for 1.200x600 panel
Kit de superficie para painel 1.200x600



FT-8000/F8032 **8,06 €***

Kit de suspensión para panel 1200x600
Suspension kit for 1200x600 panel
Kit de suspensão para painel 1200x600

*Ecoraee incluida | included | incluída
* IVA no incluido | VAT not included | IVA não incluído

Componentes | Components | Componentes

*Ecoraee incluida | included | incluída
 * IVA no incluido | VAT not included | IVA não incluído



F8040/F8041 36,59 €*
 Panel Led 600x600



F8042/F8043 44,18 €*
 Panel Led 1200x300



F8044/F8045 92,41 €*
 Panel Led 1200x600



FT-8000/F8046 10,28 €*
 Philips driver 44W Flicker free



FT-8000/F8047 25,64 €*
 Philips driver 60W Flicker free



FT-8000/F8019 9,56 €*
 Lifud driver 30W LF-GIR030YM



FT-8000/F8060 25,20 €*
 Lifud driver 40w flicker free 0-10v



FT-8000/F8061 40,20 €*
 Lifud 40w flicker free DALI2/push



FT-8000/F8062 54,90 €*
 Lifud driver 60w flicker free DALI/0-10v/
 Push/Pwm/Rx 5

Accesorio todos los led panel
 Accessory all led panels
 Acessório todos painel led



F8063 87 €*
 Kit de emergencia 24-60V 3 horas
 Emergency kit 24-60V 3 hours
 Kit de emergência 24-60V 3 horas

*Ecoraee incluida | included | incluída
 * IVA no incluido | VAT not included | IVA não incluído

BACKLIGHT LED PANEL 600X600

Los paneles ESSENTIAL LED de Filux te permitirán crear un ambiente muy luminoso y actual por su diseño integrado y elegante. La duración de los paneles LED es mucho mayor que la de los paneles convencionales, por eso es una elección recomendada si buscamos un sistema lumínico para nuestra estancia. Alternativa mucho más ecológica.

The Filux ESSENTIAL LED panels will allow you to create a very bright and contemporary environment due to its integrated and elegant design. The length of LED panels is much longer than conventional panels, so it is a recommended choice if we are looking for an ecological light system.

Os painéis ESSENTIAL LED Filux permitem criar um ambiente muito brilhante e moderno devido ao seu design integrado e elegante. A duração dos painéis de LED é maior do que os painéis convencionais, é por isso uma escolha recomendado se procuramos um sistema de luz ecológico.



3
YEAR
WARRANTY

30.000H

CRI
>80

110°

PF
0,9

IP40

100LM/W

FILUX

SMD

10 PCS

Model	SKU	mm			kg	Power	C.Temp	Lumens	Input	€*
		A	B	C						
FT-8600	F8050	595	595	27	1,2	40W	4.000K	4.000	220-240V, 50/60Hz	23,29 €
	F8051						6.000K			

*Ecoraee incluida | included | incluída
* IVA no incluido | VAT not included | IVA não incluído

Driver incluido | Driver included | Driver incluído

Accesorios | Accessories | Acessórios

*Ecoraee incluida | included | incluída
* IVA no incluido | VAT not included | IVA não incluído



FT-8000/F8030 **16,11 €***
Marco para empotrar para panel 600x600
Recessed frame for 600x600 panel
Moldura de encastrar para painel 600x600



FT-8000/F8007 **14,73 €***
Kit de superficie para panel 600x600
Surface kit for 600x600 panel
Kit de superficie para panel 600x600



FT-8000/F8009 **6,90 €***
Kit de suspensión para panel 600x600
Suspension kit for 600x600 panel
Kit de suspensão para painel 600x600

BACKLIGHT LED PANEL 1200X300

Los paneles LED PRO de Filux te permitirán crear un ambiente muy luminoso y actual por su diseño integrado y elegante. La duración de los paneles LED es mucho mayor que la de los paneles convencionales, por eso es una elección recomendada si buscamos un sistema lumínico para nuestra estancia.

The Filux LED PRO panels will allow you to create a very bright and contemporary environment due to its integrated and elegant design. The length of LED panels is much longer than conventional panels.

Os painéis LED PRO 5 anos de garantía Filux, permiten criar un ambiente muito brilhante e moderno debido ao seu design integrado e elegante. A sua aplicação é ampla e variada. A duração dos painéis de LED é maior do que os painéis convencionais.

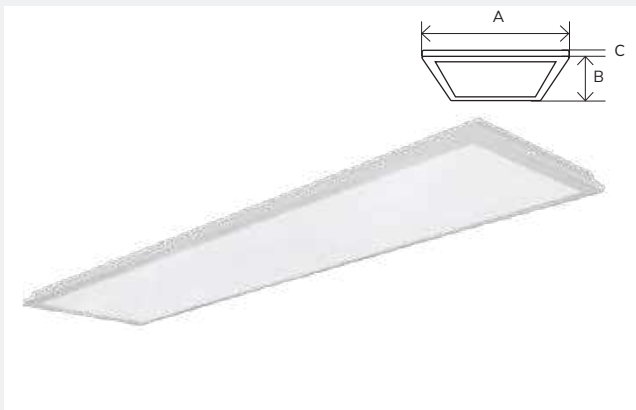

3
YEAR
WARRANTY

30.000H

CRI
>80

110°

PF
0,9

IP40

100LM/W



SMD

10 PCS



Model	SKU	mm			kg	Power	C.Temp	Lumens	Input	€*
		A	B	C						
FT-8123	F8052	1195	295	27	1,2	40W	4.000	4.000	220-240V, 50/60Hz	26,23 €
	F8053					6.000				

*Ecoraee incluída | included | incluída
* IVA no incluído | VAT not included | IVA não incluído

Driver incluido | Driver included | Driver incluído

Accesorios | Accessories | Acessórios

*Ecoraee incluída | included | incluída
* IVA no incluído | VAT not included | IVA não incluído



FT-8000/F8008 **18,96 €***

Kit de superficie para panel 1.200X300
Surface kit for 1.200X300 panel
Kit de superficie para painel 1.200X300



FT-8000/F8013 **6,90 €***

Kit de suspensión para panel 1.200X300
Suspension kit for 1.200X300 panel
Kit de suspensão para painel 1.200X300



FT-8000/F8031 **20,32 €***

Marco para empotrar para panel 1.200x300
Recessed frame for 1.200x300 panel
Moldura de encastrar para painel 1.200x300



Downlights

Downlights

Downlights



ROUND LED DOWNLIGHT

Ideales para la iluminación ambiental, reemplazo ideal de luminarias fluorescentes. El producto perfecto para la iluminación de todo tipo de interiores donde se busque dirigir la luz hacia algún punto en concreto, tanto en viviendas particulares, como para usos profesionales en comercios, restaurantes y tiendas, entre otros. Este downlight cuenta con la posibilidad de elegir la temperatura de color.

Ideal for ambient lighting, ideal replacement for fluorescent luminaires. The perfect product for the illumination of all types of interiors where it is sought to direct the light to some specific point, in private houses, for professional uses in shops, restaurants and shops, among others. This downlight offers the possibility to change the color temperature.

Ideais para iluminação ambiente. Ideal para a substituição de downlights fluorescentes. Produto perfeito para iluminação de todos os tipos de interiores onde se pretende direcionar a luz para algum ponto em concreto, tanto em uso residencial, om em uso profissional, tais como, em lojas, restaurantes , entre outros este downlight tem a possibilidade de escolher a temperatura de cor.



5
YEAR
WARRANTY

30.000H

CRI
>80

100°

PF
>0,9

TRIAC
DIMMABLE

IP44 Front

IP20 Back

ANTI-GLARE

K
3000
4000
5000
ALL IN ONE

SMD

+40° | -20°



Model	Sku	mm			g	Power	Lumens	Input	Units p/pack	€*
		A	B	Cut						
FT-9005	F9075	Ø 96	52,5	Ø 75	104,4	6W	550-620	220-240V, 50/60Hz	12	9,34 €
	F9078	Ø 150	62,5	Ø 125	246,5	11W	1.150-1300			17,52 €

*Ecoraee inclusa | included | incluída
* IVA no incluido | VAT not included | IVA não incluído

Fotometría | Photometrie | Fotometria

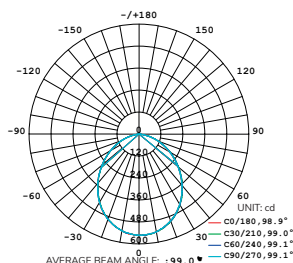

100°

Ángulo apertura
Beam angle
Ângulo de abertura

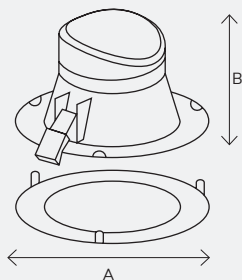

ROUND LED DOWNLIGHT ACCESSORIES

Model	Sku	Descripción Description Descrição	€*
*Ecoraee incluida included incluída * IVA no incluido VAT not included IVA não incluído			
FT-9005	F9076	Aro negro para F9075 Black hoop for F9075 Aro preto para F9075	2,57 €
	F9077	Aro cromo satinado para F9075 Chrome satin ring for F9075 Anel de cetim cromado para F9075	2,13 €
	F9079	Aro negro para F9078 Black hoop for F9078 Aro preto para F9078	3,60 €
	F9080	Aro cromo satinado para F9078 Chrome satin ring for F9078 Anel de cetim cromado para F9078	3,05 €
FT-2000	F2053	Conector IP20 IP20 connector Conector IP20	0,57 €



ROUND LED DOWNLIGHT

Ideales para la iluminación ambiental, reemplazo ideal de luminarias fluorescentes. El producto perfecto para la iluminación de todo tipo de interiores donde se busque dirigir la luz hacia algún punto en concreto, tanto en viviendas particulares, como para usos profesionales en comercios, restaurantes y tiendas, entre otros. Este downlight cuenta con la posibilidad de elegir la temperatura de color.

Ideal for ambient lighting, ideal replacement for fluorescent luminaires. The perfect product for the illumination of all types of interiors where it is sought to direct the light to some specific point, in private houses, for professional uses in shops, restaurants and shops, among others. This downlight offers the possibility to change the color temperature.

Ideais para iluminação ambiente. Ideal para a substituição de downlights fluorescentes. Produto perfeito para iluminação de todos os tipos de interiores onde se pretende direcionar a luz para algum ponto em concreto, tanto em uso residencial ou em uso profissional, tais como, em lojas, restaurantes, entre outros este downlight tem a possibilidade de escolher a temperatura de cor.



3
YEAR
WARRANTY

30.000H

CRI
>80

100°

IP44 Front

IP20 Back

K
3000
4000
6000
ALL IN ONE

SMD



Model	SKU	mm		kg	Power	Lumens	Input	Units p/pack	€*
-------	-----	----	--	----	-------	--------	-------	--------------	----

A B Cut

*Ecoraee incluída | included | incluída
* IVA no incluído | VAT not included | IVA não incluído

FT-9008	F9068	Ø 115	32	Ø 105	0,11	6W	450-500	200-240V, 50/60Hz	50	6,61 €
FT-9015	F9069	Ø 170		Ø 155	0,20	12W	1.100-1.200		40	9,24 €
FT-9020	F9070	Ø 220		Ø 205	0,33	18W	1.700-1.800		20	12,29 €
FT-9025	F9071	Ø 240		Ø 225	0,37	24W	2.200-2.400			14,73 €

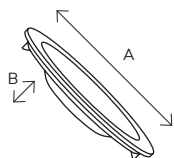



3.000K
4.000K
6.000K

Fotometría | Photometrie | Fotometria

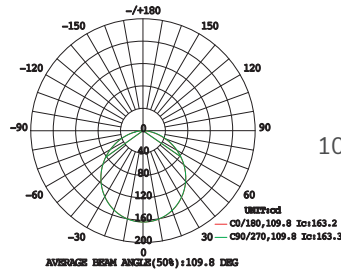

SURFACE MOUNTING KIT



Model	SKU	Descripción Description Descrição	€*
FT-9001	F9061	Kit superficie redondo para F9068 Round surface kit for F9068 Kit de superficie redondo para F9068	2,98 €
	F9062	Kit superficie redondo para F9069 Round surface kit for F9069 Kit de superficie redondo para F9069	4,17 €
	F9063	Kit superficie redondo para F9070 Round surface kit for F9070 Kit de superficie redondo para F9070	5,05 €
	F9064	Kit superficie redondo para F9071 Round surface kit for F9071 Kit de superficie redondo para F9071	5,30 €
FT-2000	F2053	Conector IP20 IP20 connector Ligador IP20	0,57 €

*Ecoraee incluída | included | incluída * IVA no incluído | VAT not included | IVA não incluído

SQUARE LED DOWNLIGHT

Ideales para la iluminación ambiental, reemplazo ideal de luminarias fluorescentes. El producto perfecto para la iluminación de todo tipo de interiores donde se busque dirigir la luz hacia algún punto en concreto, tanto en viviendas particulares, como para usos profesionales en comercios, restaurantes y tiendas, entre otros. Este downlight cuenta con la posibilidad de elegir la temperatura de color.

Ideal for ambient lighting, ideal replacement for fluorescent luminaires. The perfect product for the illumination of all types of interiors where it is sought to direct the light to some specific point, in private houses, for professional uses in shops, restaurants and shops, among others. This downlight offers the possibility to change the color temperature.

Ideais para iluminação ambiente. Ideal para a substituição de downlights fluorescentes. Produto perfeito para iluminação de todos os tipos de interiores onde se pretende direcionar a luz para algum ponto em concreto, tanto em uso residencial ou em uso profissional, tais como, em lojas, restaurantes, entre outros este downlight tem a possibilidade de escolher a temperatura de cor.



3
YEAR
WARRANTY

30.000H

CRI
>80

100°

IP44 Front

IP20 Back

K
3000
4000
6000
ALL IN ONE

SMD



Model	SKU	mm			kg	Power	Lumens	Input	Units p/pack	€*	
		A	B	C							
FT-9008	F9072	115	115	32	105X105	0,11	6W	500-600	220-240V, 50/60Hz	50	7,07 €
FT-9015	F9073	165	165		155X155	0,21	12W	1.100-1.200		40	9,77 €
FT-9020	F9074	220	220		205X205	0,33	18W	1.700-1.800		20	13,60 €

*Ecoraee incluída | included | incluída

* IVA no incluido | VAT not included | IVA não incluído

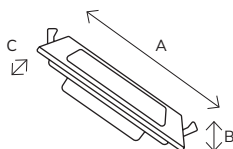

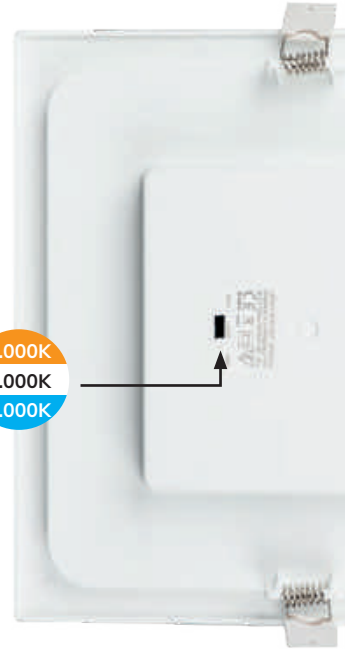

Fotometría | Photometrie | Fotometria

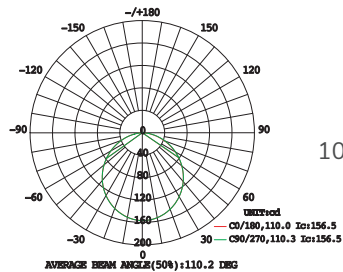

100°

Ángulo apertura
Beam angle
Ângulo de abertura

SURFACE MOUNTING KIT



Model	SKU	Descripción Description Descrição	€*
*Ecoraee incluida included incluída * IVA no incluido VAT not included IVA não incluído			
FT-9001	F9065	Kit superficie cuadrado para F9072 Square surface kit for F9072 Kit de superficie quadrada para F9072	3,06 €
	F9066	Kit superficie cuadrado para F9073 Square surface kit for F9073 Kit de superficie quadrada para F9073	4,20 €
	F9067	Kit superficie cuadrado para F9074 Square surface kit for F9074 Kit de superficie quadrada para F9074	5,42 €
FT-2000	F2053	Conector IP20 IP20 connector Ligador IP20	0,57 €

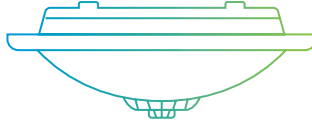

Plafones led
Led ceiling lights
Luzes de teto led

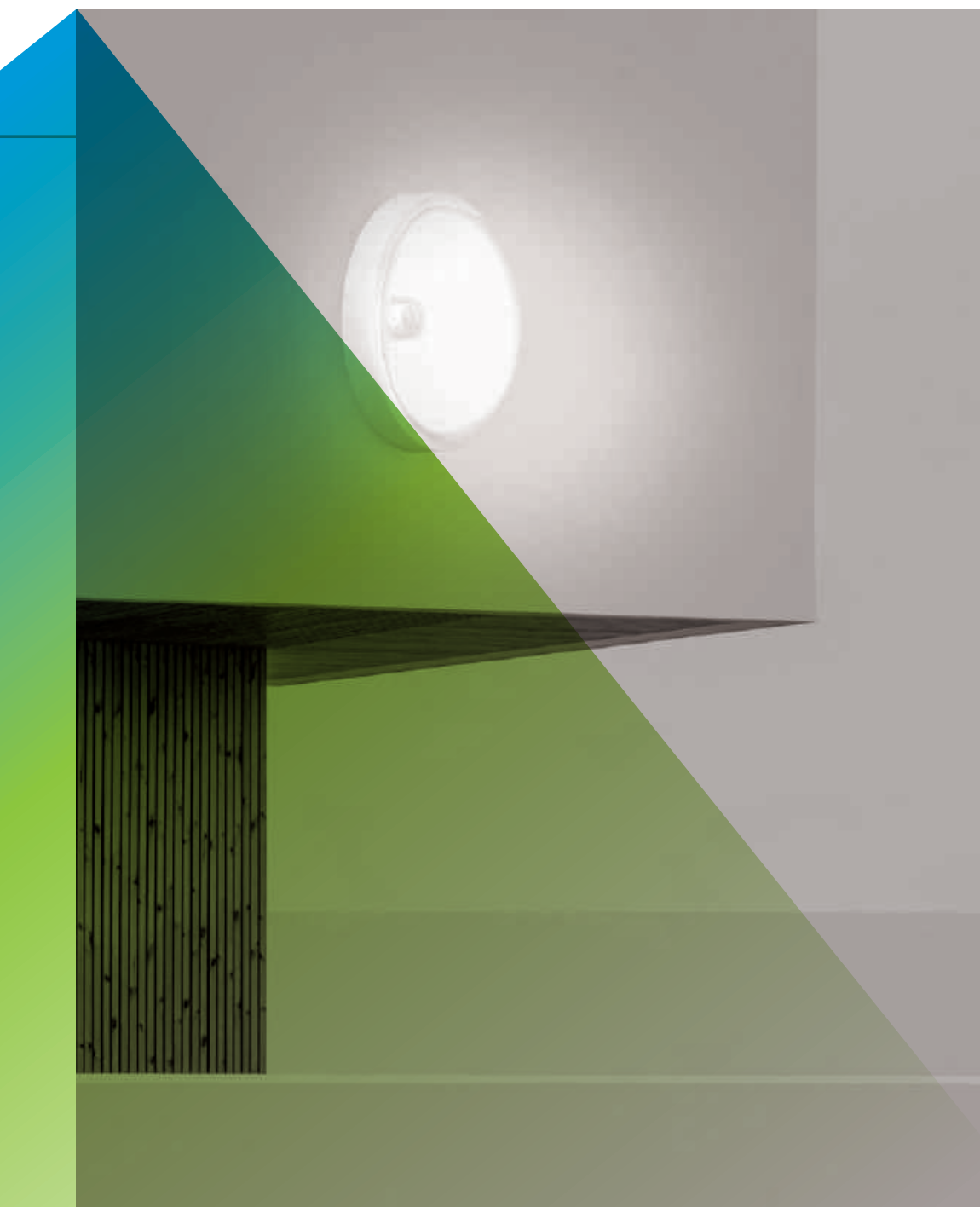

ROUND LED DOWNLIGHT

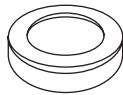

2
YEAR
WARRANTY

30.000H

CRI
>80

120°



IP65



-25° | +45°



SMD



24 PCS



Model	SKU	Color	mm	kg	Power	C.Temp	Lumens	Input	€*
-------	-----	-------	----	----	-------	--------	--------	-------	----

*Ecoraee incluida | included | incluída * IVA no incluido | VAT not included | IVA não incluído

FT-9015	F9086	White	Ø190x45	0,30	15W	3.000K	1.000	220-240V, 50/60Hz	12,99 €
	F9087					4.000K			
	F9088	Black				3.000K			
	F9089					4.000K			

Fotometría | Photometrie | Fotometria

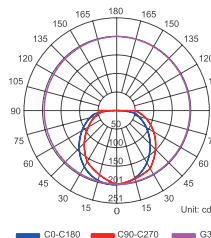

120°

Ángulo apertura
Beam angle
Ângulo de abertura

SQUARE LED DOWNLIGHT

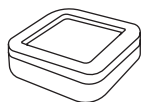

2
YEAR
WARRANTY

30,000H

CRI
>80

120°

IP65

-25° | +45°

SMD

24 PCS



Model	Sku	Color	mm	kg	Power	C.Temp	Lumens	Input	€*
-------	-----	-------	----	----	-------	--------	--------	-------	----

*Ecoraee incluida | included | incluída * IVA no incluido | VAT not included | IVA não incluído

FT-9015	F9090	White	190x190x45	0,37	15W	3.000K	1.000	220-240V, 50/60Hz	13,33 €
	F9091					4.000K			
	F9092	Black				3.000K			
	F9093					4.000K			

Fotometría | Photometrie | Fotometria

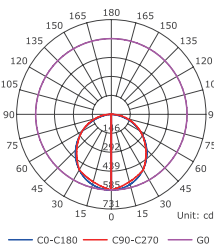

120°

Ángulo apertura
Beam angle
Ângulo de abertura

— C0-C180 — C90-C270 — G0

SURFACE LED WALL LIGHT



2
YEAR
WARRANTY

30.000H

CRI
>80

120°

IP54

-25° | +45°

SMD

20 PCS



Model	SKU	Color	mm	kg	Power	C.Temp	Lumens	Input	€*
*Ecoraee incluída included incluída * IVA no incluído VAT not included IVA não incluído									
FT-9015	F9094	Black	Ø220x68	0,40	18W	3.000K	1.260	220-240V, 50/60Hz	14,95 €
	F9095					4.000K			

Fotometría | Photometrie | Fotometria

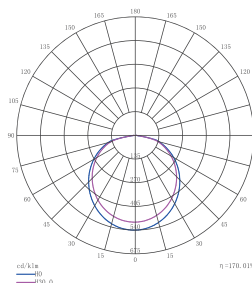

120°
Ángulo apertura
Beam angle
Ângulo de abertura

LED CEILING LIGHT



2
YEAR
WARRANTY

30,000H

CRI
>80

120°

8 PCS

IP54

IK07

-25° | +45°

PF
>0,9

SMD



Model	SKU	Color	mm	kg	Power	C.Temp	Lumens	Input	€*
*Ecoraee incluída included incluída * IVA no incluído VAT not included IVA não incluído									
FT-9015	F9098	Grey	Ø350x60	0,92	28W	3.000K	2.400	170-265V, 50/60Hz	34,30 €
	F9099					4.000K			

Fotometría | Photometrie | Fotometria

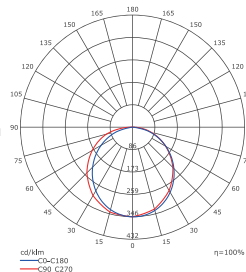

120°

Ángulo apertura
Beam angle
Ângulo de abertura

LED BULKHEAD LIGHT

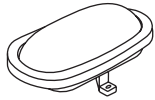

2
YEAR
WARRANTY

30,000H

CRI
>80

120°



IP64



-25° | +45°



SMD



20 PCS



Model	SKU	Color	mm	kg	Power	C.Temp	Lumens	Input	€*
*Ecoraee incluída included incluída * IVA no incluído VAT not included IVA não incluído									
FT-9015	F9096	White	216x142x79	0,18	11W	4.000K	770	220-240V, 50/60Hz	9,12 €

Fotometría | Photometrie | Fotometria

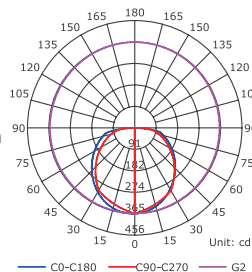

120°

Ángulo apertura
Beam angle
Ângulo de abertura

Unit: cd
— C0-C180 — C90-C270 — G2

LED BULKHEAD LIGHT

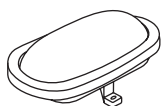

2
YEAR
WARRANTY

30.000H

CRI
>80

120°

IP64

-25° | +45°

SMD

20 PCS



Model	SKU	Color	mm	kg	Power	C.Temp	Lumens	Input	€*
-------	-----	-------	----	----	-------	--------	--------	-------	----

*Ecoraee incluída | included | incluída * IVA no incluído | VAT not included | IVA não incluído

FT-9015	F9097	Black	216x142x79	0,18	11W	4.000K	770	220-240V, 50/60Hz	9,12 €
---------	-------	-------	------------	------	-----	--------	-----	-------------------	--------

Fotometría | Photometrie | Fotometria

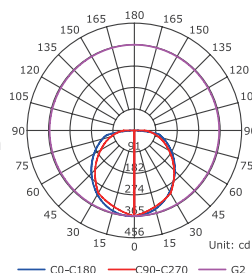

120°

Ángulo apertura
Beam angle
Ângulo de abertura

PIR SENSOR DOWNLIGHT

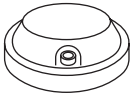

2
YEAR
WARRANTY

30.000H

CRI
>80

120°

20 PCS



IP54

-25° | +45°

**MAINTAINED/
NON MAINTAINED**

60/75s
SWITCHED
ON TIME



SMD



Model	Sku	Color	mm	kg	Power	C.Temp	Lumens	Input	€*
-------	-----	-------	----	----	-------	--------	--------	-------	----

*Ecoraee incluída | included | incluída * IVA no incluído | VAT not included | IVA não incluído

FT-9230	F9210	White	Ø200x55	0,24	18W	4.000K	1260	220-240V, 50/60Hz	17,93 €
---------	-------	-------	---------	------	-----	--------	------	-------------------	---------

Fotometría | Photometrie | Fotometria

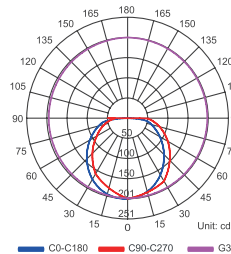

120°

Ángulo apertura
Beam angle
Ângulo de abertura

SURFACE W/MOTION PIR SENSOR

Plafón con sensor de movimiento, de fácil instalación, sin parpadeos, gran tolerancia a temperatura extremas. Perfecto para grandes áreas. Lámpara automática con sensor de ahorro energético. Reúne automatismo, comodidad, seguridad, ahorro de energía y funciones prácticas.

Ceiling with motion sensor, easy installation, no flickering, great tolerance to extreme temperatures Perfect for large areas. Automatic lamp with energy-saving sensor. Combination of comfort, safety, energy saving and practical functions.

Plafonier de teto com sensor de movimento, fácil instalação, sem cintilação, grande tolerância a temperaturas extremas. Perfeito para grandes áreas. Lâmpada automática com sensor de poupança de energia. Mais conforto, segurança, economia de energia e funções práticas.

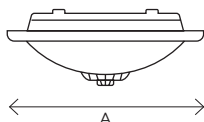

2x
E27

2
YEAR
WARRANTY

 **MOTION
SENSOR**

 **IP20**

 **360°**

 **5 PCS**



Model	Sku	mm	kg	Power	Input	Delay Time	Distance Detect.	Speed	Ambient Light	Install. Height	€*
-------	-----	----	----	-------	-------	------------	------------------	-------	---------------	-----------------	----

Retardo Detec. distancia Velocidad Luz Ambiente Altura de
Atraso Detec. distancia Velocidade Luz Ambiente instalação
Altura de
instalação

A B

*Ecorae incluida | included | incluída * IVA no incluido | VAT not included | IVA não incluído

FT-9230	F9203	Ø 300	96,8	0,66	2X E27	220-240V, 50/60Hz	Min. 10 sec ± 3sec Max. 3min ± 30 sec	6m Max (<24°C)	0,6-1,5m/s	<3-2000lux (Aj/adj)	2,2-4m	20,92 €
---------	-------	-------	------	------	--------	-------------------	--	----------------	------------	---------------------	--------	---------



Sensores

Sensors

Sensores



INDOOR SURFACE-RECESSED PIR SENSOR

FT-9210 consta de un buen detector de sensibilidad y circuito integrado. Reúne automatismo, comodidad, seguridad, ahorro de energía y funciones prácticas. Utiliza la energía infrarroja del ser humano como fuente de señal de control y puede iniciar la carga de una vez cuando se entra en el campo de detección. Puede identificar día y noche automáticamente.

FT-9210 consists of a good sensitivity detector and integrated circuit. It combines automatism, comfort, safety, energy saving and practical functions. It uses the human's infrared energy as the control signal source and can start charging once when entering the detection field. You can automatically identify day and night.

FT-9210 consiste em um bom detector de movimento combina automação, conforto, segurança, economia de energia e funções práticas. Usa a energia infravermelha do ser humano como uma fonte de sinal de controle e se pode iniciar a partir do momento que detecta algo no campo de detecção. Permite identificar o dia e a noite automaticamente.

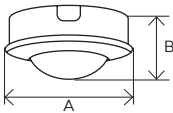

2
YEAR
WARRANTY



IP20

360°

50 PCS



Model	SKU	mm	kg	Power	Input	Delay Time	Distance Detect.	Speed	Ambient Light	Install. Height	€*
-------	-----	----	----	-------	-------	------------	------------------	-------	---------------	-----------------	----

Retardo
Atraso

Detec. distancia
Detec. distancia

Velocidad
Velocidade

Luz Ambiente
Luz Ambiente

Altura de
instalación
Altura de
instalação

		A	B	*Ecorae incluida included incluída * IVA no incluido VAT not included IVA não incluído								
FT-9210	F9201	Out Ø 80 In Ø 61,5	Out 39,6 In 37,1	0,18	Max. 800W 800W 400W	220- 240V, 50/60Hz	Min. 10 sec ± 3sec Max. 30min ± 2min	8m Max (<24°C)	0,6-1,5m/s	<3-2000lux (Aj/adj)	2,2-4m	10,13 €

OUTDOOR SURFACE PIR SENSOR

FT-9220 Detector de buena sensibilidad y circuito integrado. Reúne automatismo, comodidad, seguridad, ahorro de energía y funciones prácticas. Puede identificar día y noche automáticamente. Es fácil de instalar y utilizar ampliamente.

FT-9220 Good sensitivity detector and integrated circuit. It gathers automatism, convenience, safety, saving-energy and practical functions. It can identify day and night automatically. It is easy to install and used widely.

FT-9220 detector de boa sensibilidade. Combina automação, conforto, segurança, economia energia e funções práticas. Pode identificar dia e noite automaticamente é fácil de instalar e usar.

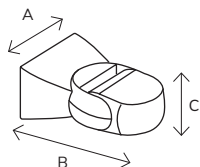

2
YEAR
WARRANTY



Model	SKU	mm	kg	Power	Input	Delay Time	Distance Detect.	Speed	Ambient Light	Install. Height	€*	
						Retardo Atraso	Detec. distancia Detec. distancia	Velocidad Velocidade	Luz Ambiente Luz Ambiente	Altura de instalación Altura de instalação		
		A	B	C			*Ecorae incluida included incluída * IVA no incluido VAT not included IVA não incluído					
FT-9220	F9202	80	119,5	51,5	0,18	Max. 1200W 300W	220- 240V, 50/60Hz	Min. 10 sec ± 3sec Max. 15min ± 2min	12m Max (<24°C)	0,6-1,5m/s	<3-2000lux (Aj/adj)	1,8-2,5 m 10,57 €

SURFACE PIR SENSOR

F9204-F9205 Buen detector de sensibilidad y circuito integrado. Reúne automatismo, conveniencia, seguridad, ahorro de energía y funciones prácticas. Utiliza la energía infrarroja del ser humano como fuente de señal de control y puede iniciar la carga de inmediato cuando uno entra al campo de detección. Puede identificar día y noche automáticamente. Es fácil de instalar y se usa ampliamente.

F9204-F9205 Good sensitivity detector and integrated circuit. It gathers automatism, convenience, safety, saving-energy and practical functions. It utilizes the infrared energy from human as control-signal source and it can start the load at once when one enters detection field. It can identify day and night automatically. It is easy to install and used widely.

F9204-F9205 Detector de movimento por infravermelho passivo (IR). Mede a luz infravermelha que é irradiada pelos objectos existentes no seu campo. Geralmente são utilizados em alarmes de segurança e/ou aplicações de iluminação automática.

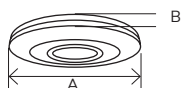

2
YEAR
WARRANTY



Model	SKU	Color	mm	kg	Power	Input	Delay Time	Distance Detect.	Speed	Ambient Light	Install. Height	€*
-------	-----	-------	----	----	-------	-------	------------	------------------	-------	---------------	-----------------	----

Retardo Detec. distancia Velocidad Luz Ambiente Altura de
Atraso Detec. distancia Velocidade Luz Ambiente Altura de
instalação

Altura de
instalação

		A	B	*Ecoraee incluida included incluída * IVA no incluido VAT not included IVA não incluído									
FT-9240	F9204	Black	∅ 115	24,3	0,18	Max. 2000W 1000W	220- 240V, 50/60Hz	Min. 10 sec ± 3sec Max. 15min ± 2min	8m Max (<24°C)	0,6-1,5m/s	<3-2000lux (Aj/adj)	2,2-4m	10,18 €
	F9205	White											

LIGHT SENSOR. PHOTOCELL

El sensor de luz F9206 puede encender o apagar la luz automáticamente de acuerdo con la luz ambiental. La temperatura ambiente y la humedad no pueden afectarlo. No solo es conveniente sino también práctico; puede controlar la carga trabajando solo de noche. Se utiliza para luz de carretera, luz de jardín, etc.

F9206 Light sensor can turn on or turn off light automatically according to ambient-light. Ambient temperature and humidity can't affect it. It is not only convenient but also practical; it can control the load working only at night. It is used for road light, garden light etc.

O detector de luz F9206, permite ligar ou desligar a luz automaticamente, dependendo la luz existente na sua zona de actuação. A temperatura ambiente e a quantidade de humidade podem afectar o seu modo de funcionamento. Geralmente são usados em iluminação exterior, em jardins, etc...

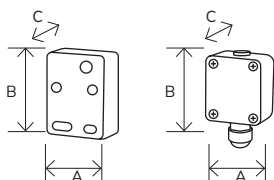

2
YEAR
WARRANTY



Model	Sku	mm			Rated current	Input	Temperature	Humidity	Ambient Light	€*
					Corriente nominal Corrente nominal		Temperatura Temperatura	Humedad Umidade	Luz Ambiente Luz Ambiente	
		A	B	C	*Ecorae incluida included incluída * IVA no incluido VAT not included IVA não incluido					
FT-9240	F9206	48 42,1	63,4 47,9	27,3 28,8	15A	220- 240V, 50Hz	-20 ~+40°C	<93%RH	<2-100lux (Aj/ adj)	10,09 €

RECESSED MICROWAVE INDOOR SENSOR

F9207 Molde de sensor de microondas con onda electromagnética de alta frecuencia (5.8GHz) y circuito integrado. Automatismo, comodidad, seguridad y ahorro de energía. Amplio campo de detección. Funciona con el movimiento humano. Cuando uno entra al campo de detección, puede iniciar la carga de inmediato e identificar automáticamente día y noche. La detección es posible a través de puertas, paneles de vidrio o paredes delgadas.

F9207 Microwave sensor mould with high-frequency electro-magnetic wave (5.8GHz) and integrated circuit. Automatism, convenience, safety, and saving-energy. Wide detection field. It works by receiving human motion. When one enters the detection field, it can start the load at once and identify automatically day and night. Detection is possible to go through doors, panes of glass or thin walls.

Detector de movimento por Micro-ondas F9207. Detecta movimento como um radar, detecta as várias mudanças de estado refletidas devido ao movimento de um objecto resultando num sinal e assim fazer o modo on ou off. Geralmente são usados para acionar as luzes da rua ou de interior, em halls, corredores, escadas, ect.

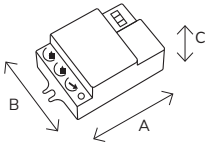

2
YEAR
WARRANTY



Model	Sku	mm	Power	Input	Delay Time	Distance Detect.	Speed	Ambient Light	Install. Height	€*
-------	-----	----	-------	-------	------------	------------------	-------	---------------	-----------------	----

Retardo
Atraso

Detec. distancia
Detec. distancia

Velocidad
Velocidade

Luz Ambiente
Luz Ambiente

Altura de
instalación
Altura de
instalação

A B C

*Ecorae incluida | included | incluída * IVA no incluido | VAT not included | IVA não incluído

FT-9240	F9207	54,5	39,4	25	Max. 1200W 300W	220- 240V, 50/60Hz	Min. 10sec ± 3sec Max. 12min ± 1min	Wall: 5-15m (adjustable) Ceiling: 1-8m (radius), adjustable	0,6-1,5m/s	<3-2000lux (Aj/adj)	Wall 5-15m (Aj/adj) Ceiling: 1-8m (radius) (Aj/adj)	10,38 €
---------	-------	------	------	----	-----------------------	--------------------------	--	---	------------	------------------------	---	---------

RECESSED PIR SENSOR

F9208 Detector de buena sensibilidad y circuito integrado. Reúne automatismo, comodidad, seguridad y ahorro de energía. Utiliza la energía infrarroja del ser humano como fuente de señal de control y puede iniciar la carga de inmediato cuando uno entra al campo de detección. Puede identificar día y noche automáticamente. Es fácil de instalar y sencillo de usar.

F9208 Good sensitivity detector and integrated circuit. It gathers automatism, convenience, safety, saving-energy and practical functions. It utilizes the infrared energy from human as control-signal source and it can start the load at once when one enters detection field. It can identify day and night automatically. It is easy to install and used widely.

F 9208 Detector de movimento por infravermelho passivo (IR). Mede a luz infravermelha que é irradiada pelos objectos existentes no seu campo. Geralmente são utilizados em alarmes de segurança e/ou aplicações de iluminação automática.

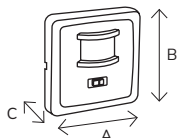

2
YEAR
WARRANTY



Model	SKU	mm	Power	Input	Delay Time	Distance Detect.	Speed	Ambient Light	Install. Height	€*
-------	-----	----	-------	-------	------------	------------------	-------	---------------	-----------------	----

Retardo
Atraso

Detec. distancia
Detec. distancia

Velocidad
Velocidade

Luz Ambiente
Luz Ambiente

Altura de
instalación
Altura de
instalação

		A	B	C	*Ecorae incluida included incluída * IVA no incluido VAT not included IVA não incluído							
FT-9240	F9208	82	82	24,7	Max. 500W 200W	220- 240V, 50/60Hz	Min. 10sec ± 3sec Max. 7min ± 2min	9m Max (<24°C)	0,6-1,5m/s	<3-2000lux (Aj/adj)	1-1,8m	9,91 €

PIR SENSOR WALL LIGHT

F9209 Buen detector de sensibilidad y circuito integrado. Reúne automatismo, conveniencia, seguridad, ahorro de energía y funciones prácticas. Utiliza la energía infrarroja del ser humano como fuente de señal de control y puede iniciar la carga de inmediato cuando uno entra al campo de detección. Puede identificar día y noche automáticamente. Es fácil de instalar y se usa ampliamente.

F9209 Good sensitivity detector and integrated circuit. It gathers automatism, convenience, safety, saving-energy and practical functions. It utilizes the infrared energy from human as control-signal source and it can start the load at once when one enters detection field. It can identify day and night automatically. It is easy to install and used widely.

F 9209 Detector de movimento por infravermelho passivo (IR). Mede a luz infravermelha que é irradiada pelos objectos existentes no seu campo. Geralmente são utilizados em alarmes de segurança e/ ou aplicações de iluminação automática.

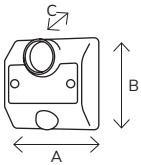

1x
E27

2
YEAR
WARRANTY

MOTION
SENSOR

IP20

360°

50 PCS



Model	SKU	mm	Power	Input	Delay Time	Distance Detect.	Ambient Light	Install. Height	€*
-------	-----	----	-------	-------	------------	------------------	---------------	-----------------	----

Re-
tardo
Atraso

Detec. distancia
Detec. distancia

Luz Ambiente
Luz Ambiente

Altura de instalación
Altura de instalação

		A	B	C	*Ecorae incluida included incluída * IVA no incluido VAT not included IVA não incluído						
FT-9240	F9209	85,5	85,5	38	Max. 60W (E27)	110- 240V, 50/60Hz	Min. 10 sec ± 3sec Max 5min ± 2min	Wall: 6m Max (<24°c) Ceiling: 6m Max (<24°c)	<3-2000lux (Aj/adj)	Wall 1,8-2,5m Ceiling: 2,2-4m	9,54 €



Luminaria de emergencia
Emergency luminaire
Luminária de emergência

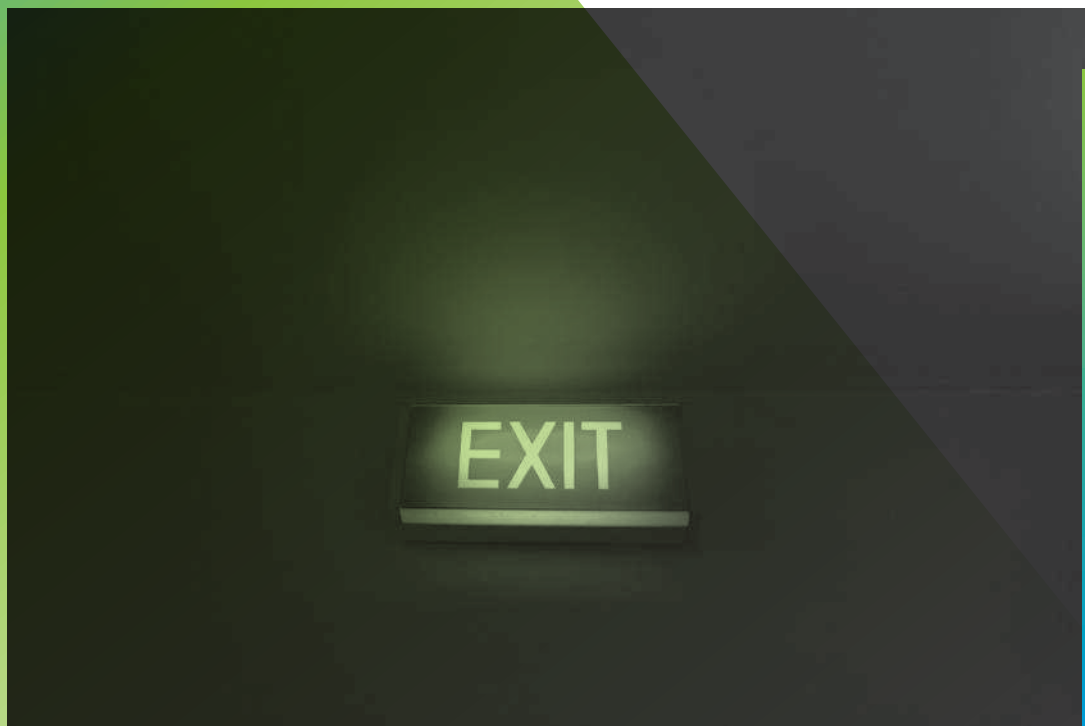

LED EMERGENCY LAMP

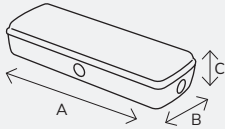

2
YEAR
WARRANTY

LITHIUM
BATTERY

MAINTAINED/
NON MAINTAINED

CRI
80

3H
EMERGENCY
DURATION

24H
FULL CHARGE
TIME

220-240V
60HZ

SMD

IP20



Model	SKU	mm			kg	Power	C.Temp	Lumens	IP	Battery	€*
		A	B	C							
FT-7000	F7010	260	95	55	0,34	3W	6.000K	100	20	3,7V 1200mAh	18,93 €

*Ecoraee incluida | included | incluida
* IVA no incluido | VAT not included | IVA não incluido

Accesorios | Accessories | Acessórios

*Ecoraee incluida | included | incluida
* IVA no incluido | VAT not included | IVA não incluido



FT-7000/F7011 **3,01 €*
Marco de empotrar
Recession kit
Kit de recessão**



FT-7000/F7012 **9,50 €*
Difusor
Diffuser
Difusor**



FT-7000/F7017 **0,48 €*
Pegatina para difusor
Adhesive for diffuser
Adesivo para difusor**

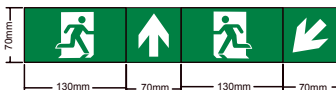

FT-7000/F7018 **0,81 €*
Pegatina para difusor
Adhesive for diffuser
Adesivo para difusor**

LED EMERGENCY LAMP

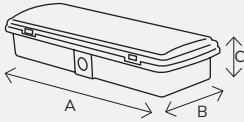

2
YEAR
WARRANTY

AUTOTEST

**LITHIUM
BATTERY**

**MAINTAINED/
NON MAINTAINED**

**CRI
80**

**3H
EMERGENCY
DURATION**

**24H
FULL CHARGE
TIME**

**220-240V
60HZ**

SMD

IP65



Model	SKU	mm			kg	Power	C.Temp	Lumens	IP	Battery	€*
		A	B	C							
FT-7000	F7013	270	100	54	0,46	4,4W	6.000K	400	65	7,2V 1500mAh	32,34 €

*Ecoraee incluida | included | incluída
* IVA no incluido | VAT not included | IVA não incluido

Accesorios | Accessories | Acessórios

*Ecoraee incluida | included | incluída
* IVA no incluido | VAT not included | IVA não incluido



FT-7000/F7014 **3,54 €* ***

Marco de empotrar
Recession kit
Kit de recessão



FT-7000/F7016 **12,70 €* ***

Difusor
Diffuser
Difusor



FT-7000/F7015 **2,68 €* ***

Carcasa de encastrar
Embed box
Caixa de embutir

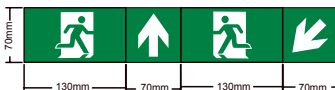

FT-7000/F7018 **1,34 €* ***

Pegatina para difusor
Adhesive for diffuser
Adesivo para difusor



FT-7000/F7017 **0,48 €* ***

Pegatina para difusor
Adhesive for diffuser
Adesivo para difusor

LED EMERGENCY DOWNLIGHT

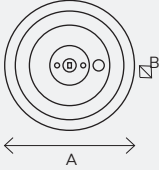

2
YEAR
WARRANTY

AUTOTEST

**MAINTAINED/
NON MAINTAINED**

CRI
80

3H
EMERGENCY
DURATION

24H
FULL CHARGE
TIME

**220-240V
60HZ**

**LiFePO₄
BATTERY**

IP20



Model	SKU	mm			kg	Power	C.Temp	Lumens	IP	Battery	€*
		A	B	Cut							
FT-7000	F7020	Ø 85 / Ø 140	23	Ø 65	0,23	3,5W	4.000K	150	20	3,2v 1,5Ah	27,23 €

*Ecoraee inclusa | included | incluída
* IVA no incluido | VAT not included | IVA não incluído

LED EMERGENCY LAMP

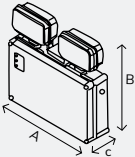

2
YEAR
WARRANTY

AUTOTEST

NON MAINTAINED

CRI
80

IP65

3H
EMERGENCY
DURATION

24H
FULL CHARGE
TIME

**220-240V
60HZ**

**Ni-cd
BATTERY**



Model	SKU	mm			kg	W	C.Temp	Lumens	IP	Battery	€*
		A	B	C							
FT-7000	F7019	300	294	77	1,90	10,5W	6.000K	650	65	12V 2800mAh	108,06 €

*Ecoraee inclusa | included | incluída
* IVA no incluido | VAT not included | IVA não incluído

EMERGENCY KIT

Protección contra sobrettemperatura
Over Temperature Protection
Proteção contra superaquecimento



3
YEAR
WARRANTY

AUTOTEST

0° | +50°

IP65

3H
EMERGENCY
DURATION

36H
FULL CHARGE
TIME

100-240V
50/60HZ

**LITHIUM
BATTERY**

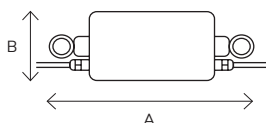

Interruptor de prueba e indicador de carga
Test switch and charge indicator
Interruptor de teste e indicador de carga

Compatible con
Compatible with
Compatível com

F6018
F6019
F6020
F6021

Model	SKU	mm		kg	Power	IP	Output	€*
		A	B					
FT-6000	F6031	280	100	2,62	30W	65	230V	255,09 €

*Ecoraee incluida | included | incluída
* IVA no incluido | VAT not included | IVA não incluido

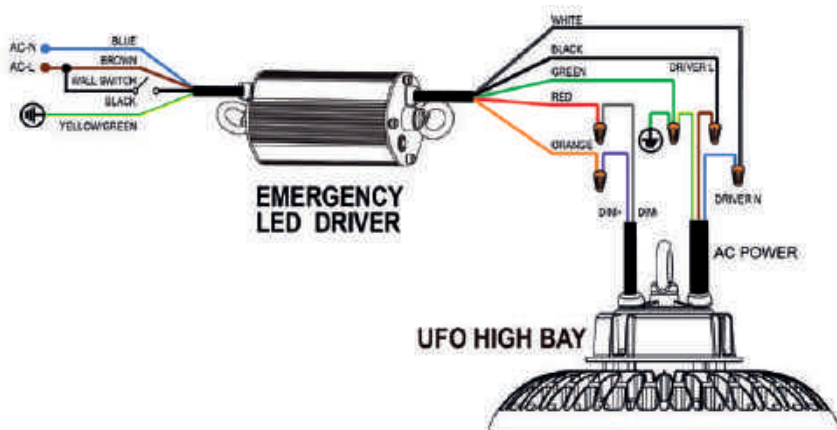

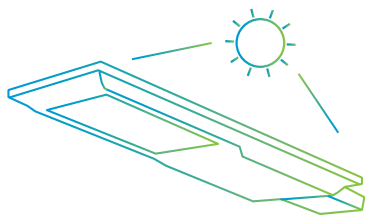

Luminaria solar
Solar luminaire
Luminária solar



LUM. SOLAR | SOLAR LUM. | LUM. SOLAR

SOLAR LED PRO STREETLIGHT

La farola solar LED Pro es una unidad de luz de sensor compacta. Ideal para utilizar en iluminación vial y urbana, incorpora una batería que hace que su funcionamiento sea autónomo

The Solar LED Streetlight Pro is a compact sensor light unit. Ideal for use in street and urban lighting, it incorporates a battery that makes it self-contained for autonomous operation.

O candeeiro de rua Solar LED Pro é uma unidade compacta unidade de luz de sensor compacta. Ideal para para utilização em iluminação pública e urbana, incorpora uma bateria que a torna autónoma para um funcionamento autónomo.



3
YEAR
WARRANTY

POWERED
BY THE SUN

TURNS ON
AT DUSK

LITHIUM
BATTERY

75° X 135°

CRI
>70

IP65

MOTION
SENSOR

5-6H
FULL CHARGE
TIME



4 PCS

SMD

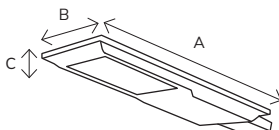

SKU	Family	mm			kg	Color	C.Temp	Lumens	Solar Panel	Distance	Battery	€*
		A	B	C								
F5277	FT-5002	752	266	45	4,36	Gray	4.000K	4200	5V/30W	6-8 m	3,2V/30AH	164,43 €

*Ecoraee incluída | included | incluída
* IVA no incluido | VAT not included | IVA não incluído



SOLAR LED PRO FLOODLIGHTS

El Foco Proyector LED Solar dispone de control remoto y no necesita estar conectado a la red eléctrica para funcionar. Cuenta con un panel solar incorporado que carga su batería ideal para ahorrar en energía o para ser instalado en zonas exteriores remotas para iluminar de forma autónoma.

The Solar LED Floodlight is remote controlled and does not need to be connected to the mains to operate. It has a built-in solar panel that charges its battery ideal for saving energy or to be installed in remote outdoor areas to illuminate autonomously.

O projetor solar LED é controlado à distância e não necessita de estar ligado à rede eléctrica para funcionar. Tem um painel solar incorporado que carrega a bateria, ideal para poupar energia ou para ser instalado em áreas exteriores remotas para iluminar de forma autónoma.



2
YEAR
WARRANTY

POWERED
BY THE SUN

TURNS ON
AT DUSK

LITHIUM
BATTERY

110°

CRI
80

IP65

7H
FULL CHARGE
TIME

F5274
5 PCS

F5276
3 PCS

SMD



SKU	Family	Floodlights mm			Solar Panel mm			C.Temp	Lumens	Solar Panel	Distance	Battery	€*
		A	B	C	A	B	C						
F5274	FT-5003	200	200	60,4	240	350	17	4.000K	2000	5V /13W	6 m	3,2V / 12AH	118,90 €
F5276	FT-5003	300	300	63,5	350	500	17	4.000K	4800	15V /32W	6 m	9,6V / 12AH	200,24 €

*Ecorae incluida | included | incluída
* IVA no incluido | VAT not included | IVA não incluído

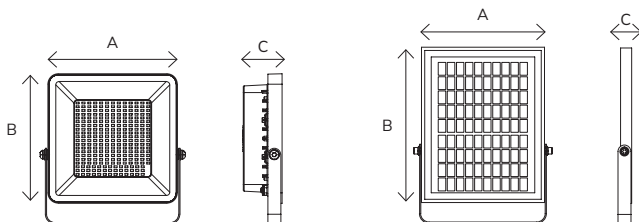

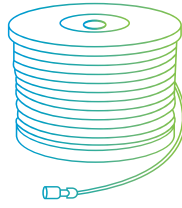

Tiras
Strips
Fitas



LED STRIPS 230V

Las tiras LED profesionales 230v Filux, con conexión directa a AC, 50 metros lineales, conexión seguida con un solo punto de alimentación, ofrecen calidad de iluminación con un bajo consumo de energía. Se permite crear espacios entornos, personalizar los espacios diferenciando el estilo.

The 230v Filux professional LED strips, with direct connection to AC, 50 linear meters, connection followed by a single power point, offer lighting quality with low power consumption. It is allowed to create special environments, customize the spaces differentiating the style.

A fita de LED profissional Filux 230v, ligação direta a AC, 50 metros lineares seguidas por um único ponto de potência. O rolo de fita de LED de 50m oferece qualidade de iluminação com baixo consumo de energia. Permite criar ambientes especiais, personalizar os espaços diferenciando o estilo.



3
YEAR
WARRANTY

CRI
>80

120°

100LM/W

PF
>0,93

IP65

50 mts



Model	SKU	mm	Power	C.Temp	Input	Led Quantity	€*
						Cantidad de led Quantidade de led	
**Ecoraee incluida included incluida * IVA no incluido VAT not included IVA não incluído							
						* €/ Metro * €/ Meter * €/ Metro	
FT-2815	F2858	40.000x12	17W/m	2.700K	220-240V, 50/60Hz	120LED/m	14,44 €
	F2859			4.000K			
	F2860			6.500K			
	F2874	50.000x12	12W/m	RGB		72LED/m	15,78 €

Accesorios | Accessories | Acessórios

*Ecoraee incluida | included | incluida
* IVA no incluido | VAT not included | IVA não incluído



F2864	Kit conector flexible atornillado IP 65 Screwed flexible connector kit Kit de conector flexível aparafusado	3,04 €
F2875	Controlador tira AC RGB Controller strip RGB AC Faixa controladora RGB AC	70,14 €
F2876	Kit conector RGB AC para F2874 RGB connector kit for F2874 Kit de conector RGB para F2874	3,63 €

LED STRIPS PRO 24V

La bobina de 10m de tira LED Filux ofrece una iluminación de calidad con muy bajo consumo energético. Permite crear ambientes especiales, personalizar espacios y darles un toque diferenciador.

The Filux 10m LED Strip coil offers quality lighting with very low power consumption. It allows to create special environments, to personalize spaces and to give them a differentiating style.

O rolo de 10m da fita de LED Filux oferece uma iluminação e qualidade com baixo consumo de energia. Permite criar ambientes especiais, personalizar espaços e dar-lhes um toque diferenciador.



5
YEAR
WARRANTY

CRI
>80

120°

100LM/W

10 mts



Model	SKU	mm	Power	Max. M connection	C.Temp	Input	IP	Led Quantity	€*
				M. Max. de conexión M. de conexão máxima					Cantidad de led Quantidade de led
*Ecoraee incluida included incluída * IVA no incluido VAT not included IVA não incluído									

* €/Rollo | * €/Roll | * €/Rolo

FT-2042	F2840	10,000 x8	4,8W/m	30 meter	2.700K	DC24V	IP20	60 LED/m	47,73 €
	F2841				4.000K				
	F2842				6.500K				
FT-2122	F2843	10,000 x10	12W/m	15 meter	2.700K	DC24V	IP20	120 LED/m	73,50 €
	F2844				4.000K				
	F2845				6.500K				
FT-2192	F2846	10,000 x10	19,2W/m	10 meter	2.700K	DC24V	IP20	120 LED/m	73,50 €
	F2847				4.000K				
	F2848				6.500K				
FT-2046	F2849	10,000 x9	4,8W/m	30 meter	2.700K	DC24V	IP20	60 LED/m	60,01 €
	F2850				4.000K				
	F2851				6.500K				
FT-2126	F2852	10,000 x11	12W/m	15 meter	2.700K	DC24V	IP65	120 LED/m	85,72 €
	F2853				4.000K				
	F2854				6.500K				
FT-2196	F2855	10,000 x11	19,2W/m	10 meter	2.700K	DC24V	IP65	120 LED/m	85,72 €
	F2856				4.000K				
	F2857				6.500K				

24V LED STRIPS ACCESSORIES

Power supply

Fuente alimentación
Power supply
Fonte de alimentação



F2869

F2871

5
YEAR
WARRANTY

-10° | +60°

Model	Sku	Power	Input V	Output V	Output Current	Efficiency	mm	IP	€*
-------	-----	-------	---------	----------	----------------	------------	----	----	----

*Ecoraee incluída | included | incluída * IVA no incluído | VAT not included | IVA não incluído

FT-2804	F2865	36W	AC100-240V, 50/60Hz	24V±5%	1.5A	≥85%	135x35x24	20	8,25 €
	F2866	60W			2.5A		170x35x24		11,33 €
	F2867	100W			4.17A		145x49x29		14,84 €
	F2868	150W			6.25A		195x49x29		20,34 €
	F2869	200W			8.3A		195x49x29		21,89 €
	F2895	300W			12.5A		245X62X29		28,16 €
	F2870	60W	AC100-277V, 50/60Hz		2.5A		203x35x25	67	16,41 €
	F2871	100W			4.17A		187X69X19		25,00 €
	F2872	150W			6.25A		187x69x19		31,21 €
	F2873	200W			8.33A		227x80x39		42,42 €

Controller

Controlador
Controller
Controlador

5
YEAR
WARRANTY

IP20

-30° | +55°



F2878



F2879



F2880



F2881



F2882

Model	Sku	Power	Input V	Output V	Output Current	mm	€*
-------	-----	-------	---------	----------	----------------	----	----

*Ecoraee incluída | included | incluída * IVA no incluído | VAT not included | IVA não incluído

FT-2801	F2878	180-360W	12-24VDC	5x12-24VDC	5CH,3A/CH	114x38x20	39,42 €
	F2879	60-120W		12-24VDC	Max. 5A	64X23,5X8,5	12,51 €
	F2880	72-144W	12-48VDC	12-48VDC	8A@12/24V,4A36/48V	52x52x26	22,53 €
	F2881	240-480W	12-24VDC	12-24VDC	1CH,20A	107x75x24,5	28,29 €
	F2882				1CH,20A Max.	107x75x38	28,93 €

*Ecoraee incluída | included | incluída
 * IVA no incluído | VAT not included | IVA não incluído

Power repeater

Repetidor potencia 8A
 Power Repeater 8A
 Repetidor energia 8A

192W

5
 YEAR
 WARRANTY

IP20

-30° | +55°

FT-2801 F2883	Input voltage	5-36VDC
	Input current	8.5A
	Input signal	PWM
	Output voltage	5-36VDC
	Output current	8A
	Output power	40-288W
	Output type	Constant voltage

13,81 €*

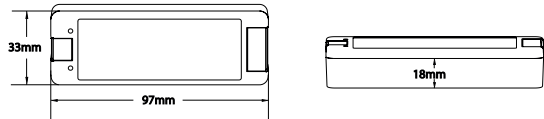

ON/OFF sensor + dimmer

Sensor ON/OFF + dimmer
 ON / OFF sensor + dimmer
 Sensor ON / OFF + dimmer

75W

5
 YEAR
 WARRANTY

-30° | +55°

FT-2801 F2884	Input voltage	12-24VDC
	Output voltage	12-24VDC
	Output power	Max. 36W@12V Max. 72W@24V
	Output type	Constant voltage

8,75 €*

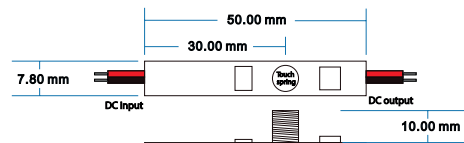
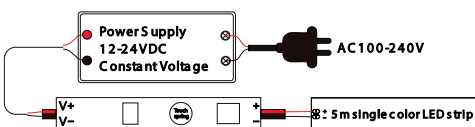

24V LED STRIPS ACCESSORIES

Door sensor

Sensor de puerta
Door sensor
Sensor da porta

96W

5
YEAR
WARRANTY

-30° | +55°

FT-2801 F2885	Input voltage	12-24VDC
	Output voltage	12-24VDC
	Output power	Max. 48W@12V Max. 96W@24V
	Detect. distance	<10 cm
	Detect. angle	15-30

8,75 €*

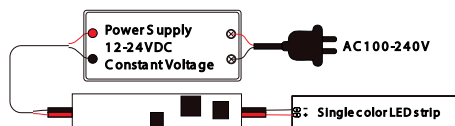
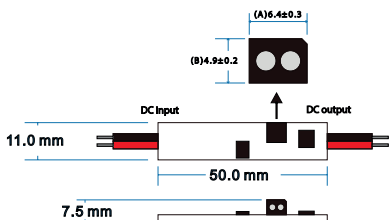

Motion sensor

Sensor de movimiento
Motion sensor
Sensor de movimento

72W

5
YEAR
WARRANTY

-30° | +55°

FT-2801 F2886	Input voltage	12-24VDC
	Output voltage	12-24VDC
	Output power	Max. 36W@12V Max. 72W@24V
	Detect. distance	<3m
	Detect. angle	120

10,03 €*

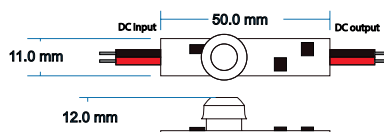
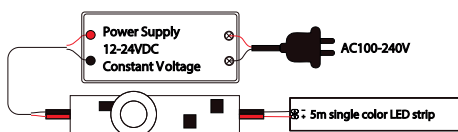

24V LED STRIPS ACCESSORIES

RH single-color remote control

Mando monocolor RF 1 zona
RF single-color remote control 1 zone
Controlo remoto RF com uma cor 1 core

5
YEAR
WARRANTY

IP20

-30° | +55°

FT-2801 F2889	Output signal	RF(2.4GHz)
	Working voltage	3VDC(AAAx2)
	Working current	<5mA
	Standby current	<2μA
	Standby time	2 years
	Remote distance	30m

12,44 €*

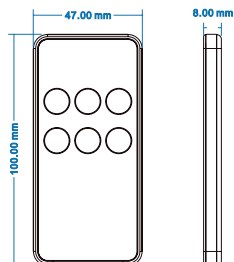

RH wireless push button

Pulsador inalámbrico RF 1 zona
RF wireless push button 1 zone
Botão sem fio RF de 1 zona

5
YEAR
WARRANTY

IP20

-30° | +55°

FT-2801 F2890	Output signal	RF(2.4GHz)
	Working voltage	3VDC(CR2032)
	Working current	<5mA
	Standby current	<2μA
	Standby time	2 years
	Remote distance	30m

17,55 €*

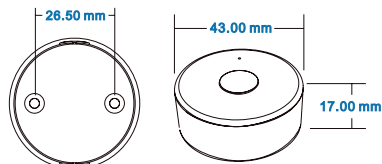

*Ecoraee incluída | included | incluída
 * IVA no incluído | VAT not included | IVA não incluído

RF wireless push button switch

Interruptor inalámbrico RF para pulsador
 RF Wireless Push Button Switch
 Interruptor de botão de pressão sem fio RF

5
YEAR
WARRANTY



-30° | +55°

FT-2801 F2891	Output signal	RF(2.4GHz)
	Working voltage	3VDC(CR2032)
	Working current	<5mA
	Standby current	<2µA
	Standby time	2 years
	Remote distance	30m

17,55 €*

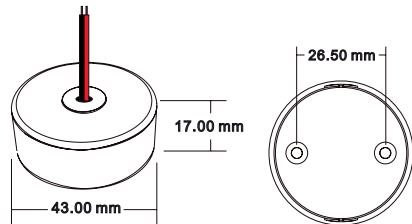

Wireless on / off switch

Pastilla interruptor inalámbrico ON/OFF
 Wireless ON / OFF switch
 Interruptor ON/OFF sem fio

5
YEAR
WARRANTY



-30° | +55°

FT-2801 F2892	Input voltage	AC100-240V
	Output voltage	AC100-240V
	Output current	Max 3A
	Output power	300-720W
	Input signal	RF 2.4GHz+Push switch
	RF Cont. distance	30m

28,79 €*

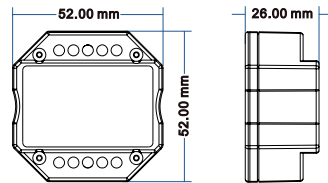

LED STRIPS ACCESSORIES

AC triac wireless regulator pickup

Pastilla regulador inalámbrico AC TRIAC
AC TRIAC Wireless Regulator Pickup
Pastilha regulador TRIAC AC sem fio

5
YEAR
WARRANTY

IP20

-30° | +55°

FT-2801 F2893	Input voltage	AC100-240V	28,15 €*
	Output voltage	AC100-240V	
	Output current	Max 1,5A	
	Output power	150-360W	
	Input signal	RF 2.4GHz+Push Dim	
	RF Cont. distance	30m	

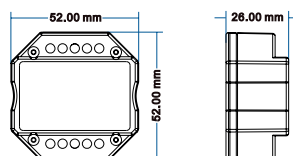

Central wifi

Central WIFI
Central WIFI
Central Wi-Fi

5
YEAR
WARRANTY

IP20

-30° | +55°

FT-2801 F2894	Operating V & Current:	DC5-24V,300mA	50,70 €*
	Wireless standard:	802.11 b/g/n	
	Frequency range	2.412GHz~2.484GHz	
	Remote Distance:	30m	
	Standby time	2 years	
	Remote distance	30m	

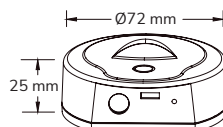

ALUMINIUM PROFILES

*Ecoraee incluida | included | incluída * IVA no incluido |
VAT not included | IVA não incluído



FT-2802
F2814

Perfil ángulo opaco 2 Mts
Opaque angle profile
2 Mts
Perfil Ângulo opaco 2 Mts

13,47 €* |



FT-2802
F2815

Perfil para empotrar 2 Mts
Recessed aluminium profile 2 Mts
Perfil encastrar 2 Mt

11,94 €* |



FT-2802
F2816

Perfil para superficie 2 Mts
Surface profile 2 Mts
Perfil superfície 2 Mts

11,07 €* |



Bombillas

Bulbs

Lâmpadas



GU10 LED BULB 6,5W

Esta bombilla LED de Filux con conexión GU10 nos proporciona un agradable tono de luz. Supone una alternativa muy buena con amplias posibilidades de decoración y gran ahorro energético. Su instalación es muy sencilla, basta con retirar el halógeno tradicional y situar la nueva lámpara con casquillo GU10 con conexión directa a la red.

This Filux LED bulb with GU10 connection provides a pleasant light tone. That means a very good alternative with ample possibilities of decoration and great energy saving. Its installation is very simple, just remove the traditional halogen and place the new lamp with GU10 bushing with direct connection to the network.

Esta lâmpada LED Filux com ligação GU10 fornece um tom de luz bastante agradável. É uma alternativa com amplias possibilidades de decoração e grande poupança energética. Sua instalação é muito simples, basta remover a lâmpada de halógeno tradicional e colocar a nova lâmpada GU10 com ligação direta à rede.

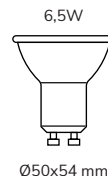

2
YEAR
WARRANTY

15.000H

CRI
>80

110°

IP20

GU10

100 PCS



Model	SKU	Power	C.Temp	Lumens	Input	€*
FT-1507	F1513	6,5W	3.000K	560	220-240V, 50Hz	2,33 €
	F1514		4.000K			
	F1515		6.500K			

*Ecoraee incluida | included | incluída * IVA no incluído | VAT not included | IVA não incluído

GU10 LED DICHROIC BULB 4W

La bombilla Dicroica LED de Filux con conexión GU10 nos proporciona un agradable tono de luz. Su instalación es muy sencilla, basta con retirar el halógeno tradicional y situar la nueva lámpara con casquillo GU10 con conexión directa a la red.

Filux LED dichroic bulb with GU10 connection provides a pleasant light tone. Its installation is very simple, just remove the traditional halogen and place the new lamp with GU10 bushing with direct connection to the network.

A lâmpada LED dicroica Filux com ligação GU10 fornece um tom de luz bastante agradável. Sua instalação é muito simples, basta remover a lâmpada de halogéneo tradicional e colocar a nova lâmpada GU10 com ligação direta à rede.

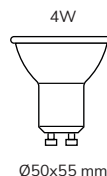

2
YEAR
WARRANTY

25.000H

CRI
>80

100°

IP20

GU10

200 PCS

SMD



Model	SKU	Power	C.Temp	Lumens	Input	€*
FT-1504	F1505	4W	3.000K	250	220-240V, 50Hz	1,49 €
	F1506		4.000K			
	F1504		6.500K			

*Ecoraee incluida | included | incluída * IVA no incluido | VAT not included | IVA não incluído

A60 LED BULB

Bombilla LED A60 E27 de Filux con una alta eficiencia energética y una vida útil de larga duración. Es ideal para sustituir a las antiguas bombillas de incandescencia con casquillo E27, consiguiendo un ahorro energético del 80%. Ofrece un encendido instantáneo y es respetuosa con el medio ambiente.

Filux LED bulb A60 E27 with high energy efficiency and long life. It's ideal for replacing old incandescent bulbs with a E27 socket, achieving an 80% energy saving. It offers an instant start and is respectful with the environment.

As lâmpadas LED Filux A60 E27 de alta eficiência energética e vida longa. São ideais para substituir as lâmpadas incandescentes E27, permitindo uma economia de energia de 80%. Dispõem de acendimento instantânea e respeitam o meio ambiente.



Ø60x120 mm

2
YEAR
WARRANTY

15,000H

220°

CRI
>80

IP20

E27

SMD

100 PCS



Model	SKU	Power	C.Temp	Lumens	Input	Chip	€*
-------	-----	-------	--------	--------	-------	------	----

*Ecoraee incluida | included | incluída * IVA no incluido | VAT not included | IVA não incluído

FT-1605	F1601	5W	3.000K	470	220-240V, 50Hz	EPISTAR LED	1,47 €
	F1602		4.000K				
	F1603		6.500K				
FT-1610	F1633	8W	3.000K	840		OSRAM LED	1,68 €
	F1634		4.000K				
	F1635		6.500K				
FT-1612	F1636	11W	3.000K	1.100		SAMSUNG LED	2,04 €
	F1637		4.000K				
	F1638		6.500K				
FT-1616	F1639	13,7W	3.000K	1.600	SAMSUNG LED		2,67 €
	F1640		4.000K				
	F1641		6.500K				

A55 LED BULB

Bombilla LED A55 E27 de Filux con una alta eficiencia energética y una vida útil de larga duración. Es ideal para sustituir a las antiguas bombillas de incandescencia con casquillo E27, consiguiendo un ahorro energético del 80%. Ofrece un encendido instantáneo y es respetuosa con el medio ambiente.

Filux LED bulb A55 E27 with high energy efficiency and long life. It's ideal for replacing old incandescent bulbs with a E27 socket, achieving an 80% energy saving. It offers an instant start and is respectful with the environment.

Lâmpada LED A55 E27 Filux, de alta eficiência energética e vida útil longa. É ideal para a substituição das lâmpadas antigas de incandescência, permitindo uma poupança de energia até 80%. É de acendimento instantâneo e respeita o meio ambiente.

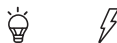

Ø55x98 mm

Model	Sku	Power	C.Temp	Lumens	Input	€*
FT-1505	F1510	5W	6.500K	400	220-240V, 50Hz	1,37 €
	F1511		3.000K			
	F1512		4.000K			

*Ecorae incluida | included | incluída
* IVA no incluido | VAT not included | IVA não incluído



R90 LED BULB 15W

La Bombilla LED FT-3515 sustituye a las lámparas incandescentes tradicionales de hasta 100W con casquillo E27. Su carcasa translúcida tiene una forma característica. Proporcionan un agradable tono de luz además de un ahorro en el consumo superior al 80%.

The FT-3515 LED Bulb replaces traditional incandescent lamps up to 100W with E27 lamp holder. It's translucent shell has a characteristic shape. They provide a pleasant tone of light in addition to a saving in consumption of more than 80%.

A lâmpada LED FT-3515 substitui as lâmpadas incandescentes tradicionais até R90 E27 de 100W. O seu corpo é translúcido têm uma forma característica. Fornecem um tom de luz muito agradável de luz, além permitir poupanças de energia até 80%.

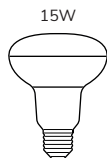

Ø90x116 mm

Model	Sku	Power	C.Temp	Lumens	Input	€*
FT-3515	F1623	15W	3.000K	1.300	175-250V, 50HZ	4,45 €
	F1624		4.000K			
	F1625		6.000K			

*Ecorae incluida | included | incluída
* IVA no incluido | VAT not included | IVA não incluído



G45 LED BULB 7,5W

Bombilla Esférica LED G45 E27 con LEDs Osram de Filux ideales para uso doméstico. Perfectas para todo tipo de aplicaciones, gracias a los múltiples tamaños y prestaciones. Obtendrás mayor eficiencia y ahorro en tu factura de la electricidad, al mismo tiempo que disfrutarás de iluminación de mayor calidad.

Filux LED Light Bulb G45 E27 with Osram LEDs ideal for home use. Perfect for all types of applications, thanks to the multiple sizes and features. You will get more efficiency and savings in your electricity bill, while enjoying better lighting.

Lâmpada esférica LED G45 E27 Filux com Chip Osram, ideal para uso doméstico. Indicada para todos os tipos de aplicação, graças aos vários tamanhos e potências. Permite maior otimização na conta de electricidade enquanto beneficia de uma iluminação de melhor qualidade.



2
YEAR
WARRANTY

15.000H

CRI
>80

220°

SMD

IP20

E27

OSRAM

100 PCS



Model	SKU	Power	C.Temp	Lumens	Input	Chip	€*
-------	-----	-------	--------	--------	-------	------	----

*Ecoraee incluída | included | incluída * IVA no incluido | VAT not included | IVA não incluído

FT-1807	F1807	7,5W	3.000K	860	220-240V, 50Hz	OSRAM LED	2,33 €
	F1808		4.000K				
	F1809		6.500K				

P45 LED BULB

Bombilla Esférica LED P45 E14 de Filux ideales para uso doméstico. Perfectas para todo tipo de aplicaciones, gracias a los múltiples tamaños y prestaciones. Obtendrás mayor eficiencia y ahorro en tu factura de la electricidad, al mismo tiempo que disfrutarás de iluminación de mayor calidad.

Filux LED Light Bulb P45 E14 ideal for home use. Perfect for all types of applications, thanks to the multiple sizes and features. You will get more efficiency and savings in your electricity bill, while enjoying better lighting.

As lâmpadas esféricas LED P45 E14 Filux, são ideais para o uso doméstico perfeias para todos os tipos de aplicações, graças aos vários tamanhos e características. Permite-lhe uma maior eficiência poupança de energia, além de lhe permitir beneficiar melhor qualidade de iluminação.



4W/7W



Ø45x78 mm

2
YEAR
WARRANTY

25.000H

CRI
>80

200°

IP20

E14

100 PCS

SMD



Model	SKU	Power	C.Temp	Lumens	Input	€*	
FT-1904	F1905	4W	3.000K	300	220-240V, 50Hz	1,55 €	
	F1906		4.000K				
	F1904		6.500K				
FT-1907	F1908	7W	3.000K	560		220-240V, 50Hz	2,02 €
	F1909		4.000K				
	F1907		6.500K				

*Ecorae incluida | included | incluída * IVA no incluido | VAT not included | IVA não incluído

C37 LED CANDLE BULB

Bombilla LED E14 de Filux de 4W y 7W de potencia, con una alta eficiencia energética y una vida útil de larga duración. Es ideal para sustituir a las antiguas bombillas de incandescencia con casquillo E14 de hasta 35W, consiguiendo un ahorro energético del 80%. Ofrece un encendido instantáneo y es respetuosa con el medio ambiente.

Filux LED bulb E14 of 4W and 7W of power, with high energy efficiency and long life duration. It's ideal to replace the old incandescence bulbs with E14 sockets of up to 35W, achieving an energy saving of 80%. It offers an instant start and is respectful with the environment.

Lâmpada vela LED E14 Filux com potências de 4W e 7W, com elevada eficiência energética e vida longa. São ideais para substituir as lâmpadas incandescentes de vela antigas com E14 de 35W, permite-nos uma poupança de energia de 80%. Têm acendimento instantâneo e respeita o meio ambiente.



4-7W



Ø60x110 mm

2
YEAR
WARRANTY

25.000H

CRI
>80

200°

SMD

IP20

E14

PF
>0,5

100 PCS



Model	SKU	Power	C.Temp	Lumens	Input	€*	
FT-1704	F1705	4W	3.000K	300	220-240V, 50Hz	1,54 €	
	F1706		4.000K				
	F1704		6.500K				
FT-1707	F1708	7W	3.000K	560		220-240V, 50Hz	2,17 €
	F1709		4.000K				
	F1707		6.500K				

*Ecorae incluida | included | incluída * IVA no incluido | VAT not included | IVA não incluído

G120 LED BULB 20W

La bombilla FT-1420 combina la eficiencia de la tecnología LED con un diseño muy característico el cual brinda una iluminación uniforme en los espacios en los cuales se utiliza. De encendido instantáneo y sin parpadeos, aportando un gran ahorro en el consumo de energía eléctrica.

The FT-1420 bulb combines the efficiency of LED technology with a very characteristic design which provides uniform illumination in the spaces in which it is used. Instantaneous and flicker-free ignition, providing great savings in electricity consumption.

A lâmpada de led FT-1420 combina a eficiência da tecnologia LED com um design muito característico que proporciona uma iluminação uniforme nos espaços em que é utilizada. Acendimento instantâneo e sem cintilações, proporcionando grande poupança de energia.

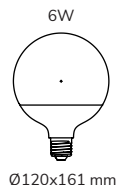

2
YEAR
WARRANTY

25.000H

CRI
>80

300°

IP20

E27

20 PCS

SMD



Model	SKU	Power	C.Temp	Lumens	Input	€*
FT-1420	F1626	20W	3.000K	1.700	175-250V, 50Hz	6,89 €
	F1627		4.000K			
	F1628		6.500K			

*Ecoraee incluída | included | incluída * IVA no incluído | VAT not included | IVA não incluído

A60 LED FILAMENT BULB 6,7W

Las bombillas LED Filamento A60 con casquillo E27 de Filux son perfectas para todo tipo de aplicaciones. Sustitutas perfectas a las bombillas tradicionales. Las bombillas LED ofrecen un gran ahorro de energía, y mantenimiento.

The Filux filament LED bulbs A60 with socket E27 are perfect for all types of applications. They are a perfect replacement for traditional light bulbs. LED bulbs offer great energy savings, and maintenance.

As lâmpadas A60 de filamento LED E27 da Filux são a solução ideal para todos os tipos de aplicações. São a substituição ideal das lâmpadas incandescentes tradicionais. As lâmpadas LED permitem grandes poupanças de energia e manutenção.

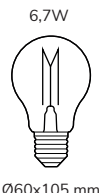

Ø60x105 mm



Model	Sku	Power	C.Temp	Lumens	Input	€*
-------	-----	-------	--------	--------	-------	----

*Ecoraee incluida | included | incluída * IVA no incluido | VAT not included | IVA não incluido

FT-1608	F1632	6,7W	2.700K	806	220-240V, 50Hz	2,71 €
---------	-------	------	--------	-----	----------------	--------

2
YEAR
WARRANTY

CRI
>80

15.000H

FILAMENT

E27

320°

IP20

PF
>0,5

100 PCS

C37 LED CANDLE FILAMENT BULB 4W

Las bombillas LED Filamento C37 con casquillo fino E14 de Filux son perfectas para todo tipo de aplicaciones. Sustitutas perfectas a las bombillas tradicionales. Las bombillas LED ofrecen un gran ahorro de energía, y mantenimiento.

The Filux filament LED bulbs C37 with fine socket E14 are perfect for all types of applications. They are a perfect replacement for traditional light bulbs. LED bulbs offer great energy savings, and maintenance.

As lâmpadas vela LED de filamento C37 casquillo E14 da Filux são ideais para todos os tipos de aplicações. São a substituição perfeita das lâmpadas incandescentes tradicionais. As lâmpadas led permitem grandes poupanças de energia e manutenção.

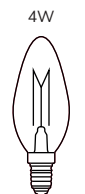

Ø35x98 mm



Model	Sku	Power	C.Temp	Lumens	Input	€*
-------	-----	-------	--------	--------	-------	----

*Ecoraee incluida | included | incluída * IVA no incluido | VAT not included | IVA não incluido

FT-1007	F1010	4W	2.700K	470	220-240V, 50Hz	2,34 €
---------	-------	----	--------	-----	----------------	--------

2
YEAR
WARRANTY

CRI
>80

15.000H

FILAMENT

E27

320°

IP20

PF
>0,5

100 PCS

G9 LED BULB 2,5W

La bombilla LED FT-3725 nos permite sustituir a las bombillas halógenas tipo bi-pin con gran ahorro energético. Integrada con LEDs Epistar-SMD3014. No necesita transformador. Con tecnología LED de alta intensidad haciendo que una bombilla tan pequeña consiga una luz potente, clara y comfortable.

The FT-3725 LED bulb allows us to replace bi-pin halogen bulbs with a great energy saving. Integrates Epistar-SMD3014 LEDs. It does not need a transformer. With high intensity LED technology making a small bulb get a powerful light, clear and cozy.

A lâmpada LED FT-3725 casquilho G9, permite substituir as lâmpadas tipo bi-pino de halogéneo com grande poupança de energia. Usa chip Epistar-SMD3014. Não necessita de transformador, pois é de ligação directa à rede 230V. Através de tecnologia de LED é possível numa lâmpada com medidas reduzidas obter uma luz potente clara e confortável.

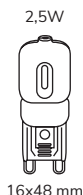

2
YEAR
WARRANTY

25.000H

CRI
>80

270°

IP20

G9

PF
>0,8

500 PCS

Model	Sku	Power	C.Temp	Lumens	Input	€*
*Ecoraee incluída included incluída * IVA no incluído VAT not included IVA não incluído						
FT-3725	F3701	2,5W	3.000K	200	220-240V, 50/60Hz	1,90 €
	F3702		4.000K			
	F3703		6.000K			

G4 LED BULB 1,5W

La bombilla G4 con un flujo luminoso de 120 lúmenes especialmente diseñada en reemplazo de las bombillas halógenas tanto lámparas decorativas como de techo. Con tecnología LED de alta intensidad haciendo que una bombilla tan pequeña consiga una luz potente, clara y comfortable.

The G4 bulb with a luminous flux level of 120 lumens, specially designed in replacemet of halogen bulbs in decorative and ceiling lights. Available in 3 light colors. With high intensity LED technology making a small bulb get a powerful light, clear and cozy.

A lâmpada G4 com um fluxo luminoso de 120 lumens especialmente desenvolvida para a substituição das lâmpadas de halogéneo decorativas. Disponíveis em temperaturas de cor. Através de tecnologia de LED é possível numa lâmpada com medidas reduzidas obter uma luz potente clara e confortável.

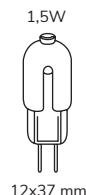

2
YEAR
WARRANTY

25.000H

CRI
>80

270°

IP20

G9

PF
>0,8

500 PCS

Model	Sku	Power	C.Temp	Lumens	Input	€*
*Ecoraee incluída included incluída * IVA no incluído VAT not included IVA não incluído						
FT-3726	F3704	1,5W	3.000K	120	DC 12V	1,90 €
	F3705		4.000K			
	F3706		6.000K			

AR111 LED BULB 12W

La bombilla FT-2718 AR111 de Filux está especialmente pensada para la iluminación de espacios interiores de índole comercial como tiendas, restaurantes u hoteles, resulta especialmente práctica para destacar determinadas zonas o expositores de productos. Se trata de espacios donde son muy comunes los focos tipo kardan donde se ubican estas bombillas.

The FT-2718 AR111 Filux lightbulb is designed for the illumination of comercial indoors, like shops, restaurants or hotels. It's specially practical for highlighting specific zones or exhibitors of products. These are spaces where the kardan type spotlights are really common, and that is where this type of lightbulb is used.

A lâmpada AR111 FT-2718 da Filux é especialmente concebida para a iluminação de espaços interiores de uso comercial, como lojas, restaurantes e hotéis. Espaços onde a utilização de luminárias do tipo estas lâmpadas são habitualmente usadas em espaços que usan spotlight com kardan.



Ø110x67 mm

LiFUD
LED Driver

3
YEAR
WARRANTY

20.000H

CRI
>80

36°

COB

IP20

G53

PF
>0,9

LIFUD

40 PCS



Model	SKU	Power	C.Temp	Lumens	Input	€*
FT-2718	F2704	12W	4.000K	1.100	220V	17,51 €

*Ecoraee incluida | included | incluida * IVA no incluido | VAT not included | IVA não incluído

R7S LED BULB

La bombilla LED FT-3811 R7S es el reemplazo de los antiguos halógenos lineales que podemos encontrar, por ejemplo en focos o lámparas de pie. De encendido instantáneo, sin parpadeos y mínima emisión de calor.

The LED bulb FT-3811 R7S is the replacement of the old linear halogens such as spotlights or floor lamps. The ignition is instantaneous, without flickers and minimum heat emission.

A lâmpada LED R7S FT-3811 permite a substituição lâmpadas antigas de halogéneo lineares que podemos encontrar, por exemplo, em projectores ou candeeiros de pé. O acendimento é instantâneo, sem piscar e com emissão mínima de calor.

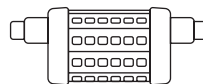

8W Ø29X78 mm

14,5W Ø29X118 mm

2
YEAR
WARRANTY

25.000H

CRI
>80

330°

TRIAC
DIMMABLE

IP20

R7S

PF
>0,9

100 PCS



Model	SKU	Power	C.Temp	Lumens	Input	€*
FT-3811	F3813	8,5W	2.700K	1.060	220-240V	7,24 €
	F3814		4.000K			
	F3815	15W	2.700K	2.000		9,75 €
	F3816		4.000K			

*Ecorae incluida | included | incluída * IVA no incluido | VAT not included | IVA não incluído

LED FITTINGS

Model	SKU	mm	Cutting size (mm)	Material	IP	Color	€*
-------	-----	----	-------------------	----------	----	-------	----

Corte

*Ecoraee incluida | included | incluída * IVA no incluido | VAT not included | IVA não incluído



FT-1500	F1550	Ø 90	Ø 70	Steel-Iron Acero-Hierro Aço-Ferro	54	○	2,00 €	
	F1551	87x87					2,05 €	
	F1552	Ø 90				●	2,00 €	
	F1553	87x87					2,05 €	
	F1555	Ø 92	Ø 88	Aluminio Aluminium Alumínio		○	5,51 €	
	F1556	89x89	84x84				5,93 €	
	F1557	Ø 85	Ø 75			6,29 €		
	F1558	85x85				6,29 €		
	F1554							0,31 €

Fabricamos à medida sob o solicitado On demand custom manufacturing

Fabricamos a medida sobre demanda

Los productos FILUX que están en el catálogo, son productos de alta rotación y demanda en el mercado actual. Se puede fabricar a medida bajo demanda cualquier tipo de iluminación que no esté presente en este catálogo.

The FILUX products that are in the catalogue, are products of high turnover and demand in the current market. Any type of LED lighting that is not present in this catalogue can be made to measure on demand.

Os produtos Filux apresentados são de elevada rotação, no entanto, podemos fabricar produtos com características diferentes se solicitado.

FILUX
BY FIT ENERGY

SITUAÇÃO GEOGRÁFICA

GEOGRAPHIC SITUATION

SITUACIÓN GEOGRÁFICA

Filux es una marca de Fit Energy y está situada geográficamente en Vitoria-Gasteiz, capital del País Vasco en España, una ciudad reconocida por la importante actividad industrial. Es una marca de economía real, que basa parte de su crecimiento en su expansión territorial. Para ello está creando una amplia red comercial y de establecimientos especializados en LEDs con firma propia o asociados.

Esta red cuenta en estos momentos con diversos puntos de venta y distribución en toda España y Portugal y así expandiéndose con varios puntos de distribución en Europa y la posibilidad de compra online a través de su web.

Filux is a Fit Energy brand is located geographically in Vitoria-Gasteiz, capital of the Basque Country in Spain, a city recognized for its important industrial activity. It is a real economy brand that bases part of its growth on its territorial expansion, for which it is creating an extensive commercial network and specialized stores in LEDs with their own firm or associates.

This network currently has various points of sale and distribution throughout Spain and Portugal and thus expanding with several distribution points in Europe and the possibility of online purchase through its website.

Filux é uma marca Fit Energy está localizada geograficamente em Vitoria-Gasteiz, capital do País Basco em Espanha e Portugal, uma cidade reconhecida pela sua importante atividade industrial. É uma marca da economia real que baseia parte de seu crescimento em sua expansão territorial, para a qual está a criar uma extensa rede comercial e especializadas em iluminação LED.

Atualmente, esta rede tem vários pontos de distribuição por Espanha, estando em franca expansão pela Europa permitindo ainda a compra online através do nosso website



NOSSOS SERVIÇOS OUR SERVICES

NUESTROS SERVICIOS



Equipo | Team | Equipa

Nuestro equipo está compuesto por un grupo de profesionales del sector de la iluminación LED, motivados, implicados y al servicio de la innovación y la mejora continua. Contamos con departamento de Ingeniería, diseño publicidad y marketing, departamento de administración, departamento de ventas, atención al cliente y logística.

Our team is composed of a group of professionals in the LED lighting sector, motivated, involved and at the service of innovation and continuous improvement, we have engineering department, design advertising and marketing, administration department, sales department, customer service and logistics.

A nossa equipa é constituída por um grupo de profissionais do sector de iluminação LED, fortemente motivados e com forte empenho no serviço de inovação e melhoria contínua. Dispomos departamento de engenharia, publicidade de design e marketing, departamento de administração, departamento de vendas, Atenção ao cliente e logística.



Soluciones | Solutions | Soluções

Contamos con distintos departamentos para brindar las soluciones que puedan surgir, como asesoramiento técnico y personalizado a nuestros clientes, un equipo de atención al cliente siempre dispuesto a resolver tus dudas y un equipo logístico para hacer que los pedidos lleguen cuando lo necesites entre otros servicios.

We have different departments to provide solutions that may arise, such as technical advice and personalized to our customers, a customer service team which is always willing to answer your questions and logistics team to place orders when you need it among other services .

Temos diferentes departamentos para fornecer várias soluções que possam surgir, tais como, apoio técnico, personalizado, uma equipa de atendimento ao cliente sempre disponível para responder a todas as questões e uma equipa de logística para dar seguimento às encomendas.



Garantía | Warranty | Garantia

FILUX, garantiza entre dos y cinco años, a partir de la fecha de compra, el funcionamiento de sus productos contra cualquier defecto en los materiales. Nuestra garantía incluye la reparación, reposición, o cambio del producto y/o componentes sin cargo alguno para el cliente.

Filux warranties are between 2 and 5 years from the day of the purchase, the performance of their products against any defect of the materials. Our warranties includes the reparations, replacement or change of any product and/or their components without any additional charge to the client.

As nossas garantias são de 2 e 5 anos a partir da data de compra, contra qualquer defeito de fabrico. As nossas garantias incluem reparações, substituição ou alteração de qualquer produto e / ou seus componentes sem qualquer custo adicional para o cliente.



Puntos de distribución | Distribution points | Pontos de distribuição

Filux irrumpió en un mercado que necesitaba productos de iluminación LED, que cumplieran con innovación, alta calidad y precio competitivo. 5 años más tarde, Filux consolida su posición como punto de referencia en España y Portugal y expande sus negocios al resto de Europa, representado en países como Francia, Italia, Inglaterra y Polonia.

Filux erupted in a market in need of LED products that accomplished innovation, high quality and a competitive price. Five years later, Filux consolidated their position as a reference point in Spain and Portugal. And it expands their business to the rest of Europe, being represented in countries such as France, Italy, the UK and Poland.

A Filux entrou num mercado que procura produtos de iluminação LED que atendam a inovação, alta qualidade e preço competitivo. Após 5 anos a Filux consolida a sua posição no mercado como uma empresa de referência no mercado Espanhol, e Português estando-se a expandir para o resto da Europa, tendo actualmente representações em França, Itália, Inglaterra e Polónia.



Servicio postventa | After-sales service | Serviço pós-venda

Contamos con servicio post venta rápido y de calidad, ya sea asesoramiento telefónico para instalación o, si los productos lo requieren, servicio de instalación. Nuestros empleados están capacitados para atender incidencias, escuchar al cliente, y brindar la mejor solución.

We have a fast and quality after-sales service, whether it's telephone advice for installation or if the products require installation service, our employees are trained to attend incidents, help the customer, and provide the best solution.

Temos um serviço de pós venda rápido de elevada qualidade, onde apoiamos e esclarecemos todas as dúvidas que os nossos clientes nos apresentam a cerca dos nossos produtos. A nossa equipa comercial dispõem de elevada formação técnica que permite solucionar os problemas ou dúvidas e aconselhar sobre qual a melhor solução para cada caso.

ESTUDOS LUMINOTÉCNICOS LIGHT TESTS

ESTUDIOS LUMÍNICOS

En nuestras instalaciones de Vitoria-Gasteiz, en España, contamos con profesionales y equipos altamente especializados, como nuestro espectrómetro, un gran instrumento que mide distintos datos de nuestras luminarias, así como la temperatura de color, flujo luminoso, índice de distribución de color, parámetros eléctricos, fotometrías y colorimetrías.

In our facilities of Vitoria-Gasteiz, in Spain, we have professionals and highly specialized equipment, like our spectrometer, a great instrument that measures different data from our luminaires, like color temperature, luminous flux, color distribution index, electrical parameters, photometry and colorimetry.

Nas nossas instalações em Vitoria-Gasteiz, Espanha, dispomos de uma equipa de profissionais e de equipamentos altamente sofisticados, como o nosso espectrómetro, um instrumento que mede diferentes dados das nossas luminárias, bem como a temperatura da cor, fluxo luminoso, índice de distribuição de cores, parâmetros elétricos, fotometria e colorimetria, entre outros..



CERTIFICAÇÕES

CERTIFICATIONS

CERTIFICACIONES

RoHS

El certificado ROHS (Restriction of Hazardous Substances), garantiza la restricción de ciertas sustancias peligrosas en aparatos eléctricos y electrónicos. Pretende promover el reciclaje, la reutilización y la recuperación de los residuos de estos equipos para reducir su contaminación.

The ROHS certificate (Restriction of Hazardous Substances) guarantees the restriction of certain dangerous substances on electrical and electronic appliances. Its objective is to promote the recycle and recovery of the waste from these equipments to reduce their pollution.

O certificado ROHS (Restrição de Substâncias Perigosas) garante a restrição de certas substâncias perigosas em equipamentos elétricos e eletrônicos. O objetivo é promover a reciclagem, reutilização e recuperação de resíduos desses equipamentos por forma a reduzir a contaminação.



Para poder venderse en el Espacio Económico Europeo, muchos productos deben llevar obligatoriamente el marcado CE, que constituye la prueba de que el producto se ha evaluado y cumple los requisitos de seguridad, sanidad y protección del medio ambiente exigidos por la UE.

To be able to sell in the European Economic area they must carry the CE mark, this constitutes the proof that this product was evaluated and it complies with the requirements of security, health and protection of the environment required by the EU.

Para podermos vender os nossos produtos no espaço Económico Europeo, os produtos devem ter a marca CE, que funciona como prova de que o produto foi avaliado e cumpre os requisitos de segurança, saúde e proteção ambiental exigidos pela UE.



Entidad Nacional de Acreditación (Gov. de España). La certificación ENAC acredita el cumplimiento de los productos de la normativa vigente garantizando los resultados técnicos de las luminarias. Certificación disponible en algunos productos.

Entidad Nacional de Acreditación (Government of Spain). ENAC certification accredits compliance with the products of current regulations guaranteeing the technical results of the luminaires. Certification available on some products.

Entidad Nacional de Acreditación (Governo da Espanha). A certificação ENAC credencia a conformidade com os produtos das normas vigentes, garantindo os resultados técnicos das luminárias. Certificação disponível em alguns produtos.



Fundación eco-raee's es un Sistema Integrado de Gestión de Residuos de Aparatos Eléctricos y Electrónicos. Fundación eco-raee's representa a FIT Energy ofreciendo cobertura y asesoramiento en materia de recogida, traslado, almacenamiento y tratamiento de los residuos de aparatos eléctricos y electrónicos.

Eco-raee's foundation is an Integrated Waste Management System for Electrical and Electronic Equipment. Eco-raee's foundation represents FIT Energy offering coverage and advice on the collection, transfer, storage and treatment of waste electrical and electronic equipment.

Eco-raee's foundation é um Sistema Integrado de Gerenciamento de Resíduos de Equipamentos Elétricos e Eletrônicos. A eco-raee's foundation representa a FIT Energy, oferecendo cobertura e aconselhamento sobre a coleta, transferência, armazenamento e tratamento de resíduos de equipamentos elétricos e eletrônicos.

AVANÇO TECNOLÓGICO TECHNOLOGICAL ADVANCE AVANCE TECNOLÓGICO

La tecnología LED posee un alto potencial para mejorar nuestra calidad de vida; gracias a los más recientes avances tecnológicos, nuestro departamento técnico adapta a la perfección los diseños para su fabricación, haciendo mejor y más duraderos nuestros productos, permitiendo tener menor mantenimiento, más resistencia a los golpes, mejor eficiencia energética... es decir, estos avances nos permiten el desarrollo de productos LED cada vez más innovadores.

LED technology has a high potential to improve our life's quality, thanks to the latest technologies, our technical department perfectly adapts the designs for its manufacture, making better and more durable our products, less maintenance, more resistance to shocks, improving its energy efficiency, it means, these advances allow us to develop increasingly innovative LED products.

A tecnologia LED tem um elevado potencial para melhorar a nossa qualidade de vida, graças aos mais recentes avanços tecnológicos. O nosso departamento técnico adapta perfeitamente os nossos produtos para que na fase de fabricação, os torne com melhor desempenho bem como mais durabilidade, permitindo menos manutenção, maior resistência a choques, melhorando sua eficiência energética, ou seja, desenvolver produtos led cada vez mais inovadores.



VANTAGENS DA ILUMINAÇÃO LED

ADVANTAGES OF LED LIGHTING

VENTAJAS DE LA ILUMINACIÓN LED

Quando hablamos de las ventajas de la iluminación LED nos referimos a que el consumo de electricidad es mínimo, con un 80% de ahorro de energía y una duración de unas 10 veces más que una bombilla tradicional, siendo su vida útil de entre 30.000 y 70.000 horas dependiendo del producto. Son más resistentes a las temperaturas y generan mínima emisión de calor.

Usar tecnología LED es una alternativa sustentable, ecológica y eficiente.

When talking about the advantages of LED lighting we mean that the consumption of electricity is minimal, with savings of 80% energy, duration of about 10 times more than a traditional bulb, being its useful life between 30,000 and 70,000 hours depends on the product. They are more resistant to temperatures and generate minimal heat emission.

Using LED technology is a sustainable, ecological and efficient alternative.

Quando falamos sobre as vantagens da iluminação de LED afirmamos que o consumo de eletricidade é mínimo, com uma poupança de 80% de energia e uma duração de 10 vezes mais que uma lâmpada tradicional, atendendo uma vida útil de 30.000 a 70.000 horas.

Utilizar tecnologia LED é uma alternativa sustentável, ecológica e eficiente.

SEJA NOSSO DISTRIBUIDOR BE OUR DISTRIBUTOR SÉ NUESTRO DISTRIBUIDOR

Queremos que trabajes con nosotros, ser más competitivos en el sector de la iluminación, y para ello te presentamos nuestro catálogo de suministros LED.

Al trabajar con nosotros podrás realizar mejores presupuestos en tus instalaciones y beneficiarte de numerosas ventajas.

We want you to work with us, to be more competitive in the LED lighting market, and for that we present you our catalogue of LED supplies.

When working with us you will be able to realize better budgets for your instalations and benefit from numerous advantages.

Gostariamos que fosse nosso parceiro de negócio, ser mais competitivo no sector de iluminação e por esse motivo apresentamos o nosso catálogo de iluminação LED.

Ao ser nosso parceiro, irá ter maior facilidade na execução de propostas comerciais além de ir beneficiar de inúmeras vantagens.





INFORMAÇÃO CATÁLOGO













CATALOGUE INFO

INFORMACIÓN CATÁLOGO

Dentro de este catálogo, podrás ver distintos iconos que explicamos a continuación.

Within this catalogue, you will see different icons explained below.















Neste catálogo, serão apresentados símbolos diferentes que explicaremos de seguida.

<p>Vida útil Useful life Vida útil</p>  <p>50.000H</p>	<p>Lúmenes/vatios Lumens/watts Lúmenes/watt</p>  <p>160LM/W</p>	<p>Compatible con NEMA NEMA Compliant Em conformidade com NEMA</p>  <p>NEMA Compatible</p>	<p>Protección IP IP protection Proteção IP</p>  <p>IP65</p>	<p>Tipo de LED LED type Tipo de LED</p>  <p>SMD</p>  <p>COB</p>  <p>FILAMENT</p>	<p>Cambio color de temperatura Color temperature switch Mudar a temperatura de cor</p>  <p>3000 4000 6000</p> <p>ALL IN ONE</p>	<p>Chip Chip Chip</p>  <p>LUMILEDS</p>
<p>Protección IK IK protection Proteção IK</p>  <p>IK08</p>	<p>Índice de reproducción cromática Color rendering index Índice de reprodução cromática</p> <p>CRI</p> <p>>80</p>	<p>Conector Connector Casquilho</p>  <p>E27</p>	<p>Factor de potencia Power factor Fator de potência</p> <p>PF</p> <p>>0,95</p>	<p>Garantía Warranty Garantia</p> <p>5 YEAR WARRANTY</p>	<p>Sensor de movimiento Motion sensor Sensor de movimento</p>  <p>MOTION SENSOR</p>	<p>Regulación Regulation Regulação</p>  <p>1-10 V</p>

Nossos símbolos

Our icons

Nuestros iconos

Driver Driver Transformador	Regulación del tiempo Time dimming Temporizador	Ángulo de apertura Beam angle Ângulo de abertura	Temperatura de trabajo Working temperature Temperatura de trabalho	Dimensiones Dimensions Dimensões	Unidades por embalaje Units per pack Unidades por embalagem	Precio Price Preço
						
MEANWELL	TIME DIMMING	120°	W.TEMP	DIMENSIONS	100 PCS	€*
						
SHAPE	POWER	4KV	W	UGR <19	LUMENS	ADJUSTABLE
Forma Shape Forma	Energía Power Potência	Protección contra sobretensión Surge protection Proteção contra sobretensão	Vatios Watts Watts	Índice de deslumbramiento unificado Unified glare rating Classificação de brilho unificado	Lúmenes Lumens Lúmenes	Dirección de posición ajustable Adjustable position direction Direção da posição ajustável

TERMINOLOGIA

TERMINOLOGY

TERMINOLOGIA

ESP

LÚMENES: Es la intensidad luminosa uniforme repartida en un ángulo sólido de un estereorradián y su flujo luminoso total emitido en esta dirección se llama lumen. Una manera más sencilla de definir lumen sería decir que es la cantidad total de luz visible en una dirección o ángulo proyectada sobre una superficie.

LM/W: Lúmenes emitidos por cada vatio de electricidad.

WATIO: Unidad de medida de potencia.

EN

LUMENS: It is the uniform luminous intensity distributed in a solid angle of a steradian and its total luminous flux emitted in this direction is called lumen. A simpler way to define lumen would be to say that it is the total amount of light visible in a direction or angle projected onto a surface.

LM/W: This calculation indicates the amount of lumens emitted per watt of electricity.

WATT: Unit of measurement of power.

PT

LUMENS: é a unidade de medida de fluxo luminoso. Um lúmen é o fluxo luminoso total emitido em uma direção ou ângulo projectado em uma superfície.

LM / W: esta unidade de medida indica o número de lúmens emitidos por watt de eletricidade.

WATT: unidade de medida de potência.

EQUIVALENCIA EN WATIOS: Es la comparativa entre Watios/Lúmenes de una bombilla convencional aplicada a la tecnología LED.

VOLTAJE / FRECUENCIA: El voltaje es la fuerza que impulsa los electrones. La frecuencia es el número de veces que se repite la señal en un determinado tiempo. Ambos son componentes de la corriente alterna.

CRI: El CRI o Índice de Reproducción Cromática es una medida de la capacidad que una fuente luminosa tiene para reproducir fielmente los colores de varios objetos en comparación con una fuente de luz natural o ideal.

EQUIVALENCE IN WATTS: It is the comparison between watts / lumens of a light bulb applied to LED technology.

VOLTAGE / FREQUENCY: Voltage is the force that drives the electrons. The frequency is the number of times the signal is repeated in a certain time. Both are components of the alternating current.

CRI: The CRI or Chromatic Reproduction Index is a measure of the ability of a light source to faithfully reproduce the colors of various objects compared to a natural or ideal light source.

EQUIVALÊNCIA EM WATTS: é a comparação entre watts / lumens de uma lâmpada aplicada à tecnologia LED.

TENSÃO / FREQUÊNCIA: a tensão é a força que impulsiona os elétrons. A frequência é o número de vezes que o sinal é repetido em um determinado tempo. Ambos são componentes da corrente alternada.

CRI: o cri ou índice de reprodução de cores é uma medida da capacidade de uma fonte de luz para reproduzir com exatidão as cores de vários objetos em comparação com uma fonte de luz natural ou ideal.

PF: El Factor de Potencia es el porcentaje de energía que es aprovechada por un sistema electrónico como luminarias LED, televisiones, ordenadores o cualquier aparato electrónico. Este dato es importantísimo para saber el aprovechamiento energético del equipo y determinar su calidad.

ÁNGULO DE APERTURA: Es un parámetro importante, especialmente en las lámparas de iluminación directa. El ángulo de apertura de luz nos indica si la lámpara iluminará un área más grande o más pequeña.

PF: The Power Factor is the percentage of energy that is taken advantage of by an electronic system such as LED luminaires, televisions, computers or any electronic device. This data is very important to know the energy use of the equipment and determine its quality.

BEAM ANGLE: It is an important parameter, especially in direct lighting lamps. The opening angle of light tells us if the lamp will illuminate a larger or smaller area.

PF: o fator de potência é a percentagem de energia que é usada por um sistema eletrônico, como luminárias led, televisões, computadores ou qualquer dispositivo eletrônico. Estes dados são muito importantes para conhecer o uso de energia do equipamento e de determinar a sua qualidade.

ÂNGULO DE ABERTURA: é um parâmetro importante, especialmente em lâmpadas de iluminação direta. O ângulo de abertura da luz indica se a lâmpada iluminará uma área maior ou menor.

EMPOTRABLE: Es una luminaria que la podremos instalar en un techo falso.

SUPERFICIE: Es una luminaria que la podremos instalar pegada al techo, ideales para lugares donde no hay techo falso.

PROTECCIÓN IP: Las características de IP indican la medida en que está protegida una lámpara de objetos, el polvo y la humedad. Las características IP constan de dos dígitos: Primer dígito: protección contra la entrada de polvo y objetos, Segundo dígito: protección contra el agua.

RECESSED: It is a luminaire that we can install on a false ceiling.

SURFACE: It is a luminaire that can be installed sticking under the ceiling, ideal for places where there is no false ceiling.

IP PROTECTION: The IP characteristics indicate the extent to which an object lamp, dust and moisture is protected. The IP characteristics consist of two digits: First digit: protection against the entry of dust and objects, Second digit: protection against water.

ENCASTRAR: é uma luminária que podemos instalar em um teto falso, encastrável.

SUPERFÍCIE: é uma luminária que podemos instalar de modo superfície, ideal para locais onde não há teto falso.

PROTEÇÃO IP: As características do IP são apresentadas por dois dígitos: primeiro dígito: proteção contra ppequenos residuos sólidos, segundo dígito: proteção contra líquidos.

TEMPERATURA DE COR

COLOR TEMPERATURE

TEMPERATURA DE COLOR

ESP

Dos luces blancas pueden ser completamente distintas. Seguro que lo ha notado cuando, tras reemplazar una bombilla fundida (algo cada vez menos frecuente gracias a la iluminación LED), ha percibido la habitación de modo diferente. Se debe a que ha colocado una bombilla, también blanca y de la misma potencia, pero con distinta temperatura de color.

La temperatura de color podría definirse como la sensación que percibe el ojo humano ante una luz, siendo cálida si predomina el color ámbar o fría si predomina el azul. Esta medición solo se aplica a la luz blanca y técnicamente se define como "la impresión de color a ciertas temperaturas de un radiador de cuerpo negro perfecto", según la guía de la Federación de Asociaciones Europeas de Luminarias y Componentes para Luminarias.

El concepto es más simple de lo que parece. Piense en un hierro incandescente al que se le va aplicando cada vez más calor. Cuando su temperatura se sitúa a unos 1.000 K (grados kelvin) adquiere una tonalidad rojiza. Si la temperatura sube hasta situarse entre 2.000 y 3.000 K su color se vuelve amarillento. A 4.000 K su tono es blanco neutro y entre 5.000 y 7.000 K blanco frío. Sin embargo, cuando hablamos de luz, la "temperatura" es sólo una medida relativa: no tiene que ver con el calor físico sino con la sensación que produce en el ojo humano.

EN

Two white lights can be completely different. Surely you have noticed when, after replacing a fused light bulb (something less and less frequent thanks to LED lighting), you have perceived the room differently. It is because you have placed a bulb, also white and of the same power, but with different color temperature.

The color temperature could be defined as the sensation that the human eye perceives about a light, being warm if the amber prevails or cold color if the blue predominates. This measurement only applies to white light and is technically defined as the "color printing at certain temperatures of a perfect black body radiator", according to the guide of the Federation of European Luminaires and Components Associations for Luminaires.

The concept is simpler than it seems. Think of an incandescent iron that is getting more and more heat. When its temperature is about 1,000 K (Kelvin degrees) it takes on a reddish hue. If the temperature rises to between 2,000 and 3,000 K its color turns yellowish. At 4,000 K its tone is neutral white and between 5,000 and 7,000 K cold white. However, when we speak of light, "temperature" is only a relative measure: it has nothing to do with physical heat but with the sensation it produces in the human eye.

PT

Duas luzes brancas podem ser completamente diferentes. Certamente já notou que, depois de substituir uma lâmpada fundida (algo cada vez menos frequente graças à iluminação por LED), o ambiente apresenta-se de forma diferente. É porque colocou uma lâmpada, também branca e com a mesma potência, mas com temperatura de cor diferente.

A temperatura de cor pode ser definida como a sensação percebida pelo olho humano antes de uma luz, sendo quente se âmbar ou frio se predominar, a cor azul. Esta medição aplica-se apenas à luz branca e é tecnicamente definida como "a emissão de cores a determinadas temperaturas de um corpo negro radiador", de acordo com o guia da federação de associações de componentes e luminárias europeias.

O conceito é mais simples do que parece. Pense num ferro incandescente ao qual se vai aplicando mais e mais calor. Quando sua temperatura está em torno de 1.000 k (graus kelvin), ela adquire uma tonalidade avermelhada. Se a temperatura subir entre 2.000 e 3.000 K, a sua cor fica amarelada. Aos 4.000 k seu tom é branco neutro e entre 5.000 e 7.000 K branco frio. No entanto, quando falamos de luz, "temperatura" é apenas uma medida relativa: não tendo nenhuma relação com o calor físico, mas com a sensação que produz no olho humano.

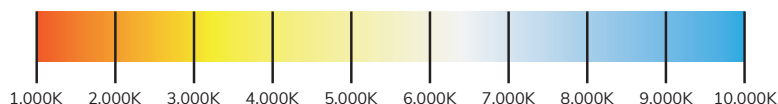

Condiciones generales de venta y suministro de FIT Energy S.L. para europa

GENERALIDADES: Para la venta y suministro que realice FIT Energy, S.L. serán de aplicación las siguientes condiciones generales.

OFERTAS: Nuestras ofertas, bien escritas u orales, se entienden sin compromiso por nuestra parte, son sólo a título informativo, salvo que especialmente se pactara lo contrario, no significando en ningún caso compromiso de aceptación del pedido.

PEDIDOS: Son aceptados con la condición expresa de que queda reservado el derecho de modificar los precios y condiciones de venta por nuestra parte. En los casos de modificación de pedidos con suministros parciales, los clientes tendrán la facultad de anular las mercancías que quedaren pendientes de suministro, o bien aceptar el resto del pedido con las nuevas condiciones.

PRECIOS: Los precios se entienden por mercancías puestas en los Almacenes de FIT Energy, S.L. incluidos los embalajes normales (las dimensiones del embalaje de envío pueden variar dependiendo de la procedencia de la mercancía), siendo por cuenta del cliente cualquier protección o embalaje adicional. Franquicia de portes de 10 €, para pedidos con valor base mínimo de 300 € en península y de 1.000 € en Canarias, Baleares, Ceuta y Melilla, portes gratis.

Por su parte, los costes de envíos realizados a otros países de Europa deberán consultarse previamente a la finalización del proceso de compra ya que dependerán de diferentes condiciones, entre otras, el importe de la compra, lugar de envío, envío urgente, etc.

SUMINISTROS: Las mercancías viajan por cuenta y riesgo del comprador, aunque en los albaranes figuren portes pagados, con independencia del medio de transporte utilizado, cuya elección queda reservada a FIT Energy, S.L.

En caso de rotura, robo, avería, naufragio y extravío, el comprador o destinatario podrá reclamar al transportista, eximiendo a FIT Energy, S.L. de responsabilidad alguna en cuanto a la falta de material o al tiempo transcurrido en la expedición. El comprador asumirá los gastos que se produzcan en el transporte, siempre que, atendiendo a sus peticiones, éste se realizará por algún medio o agencia de transportes elegido por él mismo. FIT Energy, S.L. podrá realizar suministros y, consecuentemente, facturaciones parciales referidas a pedidos del comprador.

PLAZOS: Los plazos de entrega se consideran siempre aproximados y no podrá exigirse responsabilidad a causa de retrasos por fuerza mayor u otras circunstancias propias o ajenas a la voluntad de FIT Energy, S.L. no dando derecho al comprador a indemnizaciones ni anulaciones en los pagos por los pedidos realizados.

PAGOS: Salvo pacto en contrario, el pago se realizará en Vitoria-Gasteiz en las condiciones convenidas por ambas partes. En caso de demora en los pagos, se cargará al comprador el interés correspondiente, así como cualquier gasto de renovación o aplazamiento si lo hubiere. Queda reservada a FIT Energy, S.L. la facultad de fijar a cualquier

cliente el límite o cuantía máxima de crédito a conceder, así como suspender los suministros en el caso de tener el cliente pagos atrasados.

DEVOLUCIONES DE MATERIAL: No se admitirán devoluciones de material sin previa solicitud por parte del cliente y aprobación por parte de FIT Energy, S.L.

No se aceptará la devolución en los siguientes casos:

- a) Materiales que están descatalogados.
- b) Materiales que hayan sido usados con anterioridad a la devolución.
- c) Devoluciones en malas condiciones físicas, bien del material en sí o de los embalajes.
- d) Materiales no fabricados o comercializados por FIT Energy, S.L.
- e) Materiales cuyo suministro se realizó con anterioridad superior a seis meses a la fecha de la solicitud de devolución.
- f) Para realizar una propuesta de devolución es necesario indicar el número de factura o albarán del material que se pretende devolver.
- g) Salvo pacto en contrario, a la devolución se le aplicará un 5% de depreciación, FIT Energy, S.L. no se hará cargo de las devoluciones que no se remitan a portes pagados, resarciendo posteriormente al cliente, en los casos que proceda.

Siempre que el comprador acreditara devolver el material por defectos técnicos imputables al mismo, será necesario el dictamen o comprobación técnica del mismo, o de la instalación donde estuviere montado, por FIT Energy, S.L., que así lo confirme, en cuyo caso se resarcirá al comprador mediante abono o sustitución gratuita del material adquirido, sin que pueda exigirse daño o perjuicios de clase alguna.

RECLAMACIONES: FIT Energy, S.L., no aceptará reclamaciones relativas a errores en las cantidades o tipos recibidas por el cliente, siempre que no se realicen dentro de los 48 horas siguientes a la fecha en que se efectuó el suministro.

VIARIOS: Para cualquier divergencia que pudiera resultar en el cumplimiento e interpretación de las operaciones realizadas por FIT Energy, S.L. y su cliente, éste, con renuncia expresa de su propio fuero, o legislación, se somete expresamente a la jurisdicción de los Tribunales y Juzgados de Vitoria-Gasteiz. Estas condiciones derogan cualesquiera otras de fecha anterior a las mismas y permanecerán vigentes por tiempo indeterminado, en tanto no se establezcan otras nuevas con el mismo objeto.

*Para consultar las condiciones generales completas de venta visitar la web: <http://ecommerce.fitenergy.es/contenido/condiciones-generales>.

General conditions of sale and supply of FIT Energy S.L. for europe

GENERAL: For the sale and supply made by FIT Energy, S.L. the following general conditions will be applied.

OFFERS: Our offers, whether written or oral, are understood without commitment on our part, are only for information, unless otherwise agreed. That means, there is in no case commitment to accept the order.

ORDERS: They are accepted with the express condition that the right to modify the prices and conditions of sale by us is reserved. In cases of modification of orders with partial supplies, customers will have the power to cancel the goods that remain pending supply, or accept the rest of the order with the new conditions.

PRICES: The prices are understood by merchandise placed in the Warehouses of FIT Energy, S.L. including normal packaging (the dimensions of the shipping carton may vary depending on the origin of the goods), being the customer's account any additional protection or packaging. Freight charge of € 10, for orders with a minimum base value of 300 € in the peninsula and 1.000 € in the Canary Islands, Balearic Islands, Ceuta and Melilla, free of charge.

Moreover, the shipping costs to other European countries should be previously consulted at the end of the purchase process, because they will depend on various conditions, e.g., the amount of the purchase, place of delivery, express delivery, etc.

SUPPLIES: The goods travel at the buyer's risk and expense, even if the delivery notes are paid freight, regardless of the means of transport used, whose choice is reserved for FIT Energy, S.L. In case of breakage, theft, damage, wreckage and loss, the buyer or recipient can claim the carrier, exempting FIT Energy, S.L. of any responsibility regarding the lack of material or the time elapsed in the expedition. The buyer will assume the expenses that occur in the transportation, provided that, according to his requests, this will be done by some means or transport agency chosen by him. FIT Energy, S.L. may make supplies and, consequently, partial invoices referred to buyer's orders.

DEADLINES: The delivery times are always considered approximate and no liability can be demanded due to delays due to force majeure or other circumstances of their own or outside the will of FIT Energy, S.L. not giving the buyer the right to compensations or cancellations in the payments for the orders placed.

PAYMENTS: Unless otherwise agreed, payment shall be made in Vitoria-Gasteiz under the conditions agreed by both parties. In case of delay in payments, the buyer will be charged the corresponding interest, as well as any expenses of renewal or postponement if any. Reserved for FIT Energy, S.L. the power to set any client the limit or maximum amount of credit to be granted, as well as suspend the supplies in case the customer has late payments.

RETURNS OF MATERIAL: No refunds of material will be accepted without prior request from the customer and approval by FIT Energy, S.L. The refund will be not accepted in the following cases:

- a) Materials that are discontinued.
- b) Materials that have been used prior to the return.
- c) Returns in bad physical condition, either of the material itself or of the packaging.
- d) Materials not manufactured or marketed by FIT Energy, S.L.
- e) Materials whose supply was made earlier than six months prior to the date of the return request.
- f) To make a return proposal it is necessary to indicate the invoice number or delivery note of the material to be returned.
- g) Unless otherwise agreed, a 5% depreciation will be applied to the return, FIT Energy, S.L. will be not responsible for returns that are not shipped paid, subsequently recouping the client, in appropriate cases.

Whenever the buyer proves to return the material for technical defects imputable to the products, it will be necessary the opinion or technical verification of the products, or of the installation where they are installed, by FIT Energy, S.L. that confirms it, in that case purchaser will be compensated by free substituting or replacing the purchased material, without any damages or damages of any kind.

CLAIMS: FIT Energy, S.L., will not accept claims regarding errors in the quantities or types received by the customer, provided that they are not made within 48 hours following the date on which the supply was made.

VARIOUS: For any divergence that could result in the compliance and interpretation of the operations carried out by FIT Energy, S.L. and his client, expressly waiving his or her own jurisdiction, or legislation, is expressly subject to the jurisdiction of the Tribunals and Courts of Vitoria-Gasteiz. These conditions will abrogate any others dated prior to them and will remain in force indefinitely, as long as other new ones with the same object are not established.

* To consult the general conditions of sale visit the web: <http://ecommerce.fitenergy.es/contenido/condiciones-generales>.

Condições gerais de venda e fornecimento da FIT Energy S.L. para a europa

GERAL: Para a venda e fornecimento da FIT Energy, S.L. aplicam-se as seguintes condições gerais.

PROPOSTAS: As nossas propostas, sejam escritas ou verbais, são entendidas sem compromisso de nossa parte, são apenas para fins informativos, salvo acordo especial em contrário, o que significa, que em nenhum caso, compromisso para aceitar a encomenda.

ENCOMENDAS: Elas são aceites com a condição expressa de que o direito de modificar os preços e condições de venda são reservadas a FIT Energy, S.L. Nos casos de modificação de encomendas com suprimentos parciais, os clientes terão o direito de cancelar os produtos que estejam pendentes de fornecimento ou aceitar o restante da encomenda com as novas condições.

PREÇOS: Os preços são entendidos como produtos colocadas nos armazéns da FIT Energy, S.L. incluem embalagem normal (as dimensões da embalagem podem variar dependendo da origem do produto), com qualquer proteção adicional ou embalagem sendo paga pelo cliente. Valor de portes de envio de 10€, para encomendas com um valor inferior a 300€.

Os custos de envio de productos enviados para outros países europeus devem ser consultados antes da conclusão do processo de compra, uma vez que dependerão de condições diferentes, entre outros, o valor da compra, local de entrega, entrega urgente, etc.

FORNECIMENTOS: As mercadorias viajam por conta e risco do comprador, embora as notas de remessa incluam o porte pago, independentemente do meio de transporte utilizado, cuja escolha está reservada à FIT Energy, S.L.

Em caso de quebra, roubo, avaria, naufrágio e perda, o comprador ou destinatário pode reclamar à transportadora, ficando a FIT Energy, S.L. isenta de qualquer responsabilidade em relação à falta de material ou o tempo decorrido na expedição. O comprador assumirá as despesas que ocorrerem no transporte, desde que, de acordo com seus pedidos, este seja realizado por qualquer meio ou agência de transporte escolhida por ele. FIT Energy, S.L. pode fazer fornecimentos e, consequentemente, faturas parciais referiam-se a ordens do comprador.

PRAZOS: Os prazos de entrega são sempre considerados aproximados e nenhuma responsabilidade pode vir a ser exigida pelos atrasos devido a força maior ou outras circunstâncias próprias ou fora do controle da FIT Energy, S.L. não dando ao comprador o direito de compensação ou cancelamento de pagamentos por pedidos efetuados.

PAGAMENTOS: Salvo acordo em contrário, o pagamento será feito em vitoria-gasteiz, nas condições acordadas por ambas as partes. Em caso de atraso nos pagamentos, ao comprador será cobrado os juros correspondentes, bem como quaisquer despesas de renovação ou adiamento, se houver. É reservado para a FIT Energy, S.L. o poder definir a qualquer cliente o limite do montante máximo de crédito concedido, bem como suspender os fornecimentos no caso de o cliente ter atrasos nos pagamentos.

DEVOLUÇÕES DO MATERIAL: Reembolsos de material não serão aceites sem solicitação prévia do cliente e aprovação por escrito pela FIT Energy, S.L. o retorno não será aceito nos seguintes casos:

- a) Materiais descontinuados.
- b) Materiais que foram usados antes do retorno.
- c) Retorna em más condições físicas, seja do próprio material ou da embalagem.
- d) Materiais não fabricados ou comercializados pela FIT Energy, S.L.
- e) Materiais cujo fornecimento foi feito á mais de seis meses antes da data do pedido de devolução.
- f) Para fazer uma proposta de devolução, é necessário indicar o número da fatura ou nota de remessa do material que deve ser devolvido.
- g) Salvo acordo em contrário, será aplicada uma depreciação de 5% ao retorno, a FIT Energy, S.L. não será responsável por devoluções que não sejam enviadas em frete pago, subseqüentemente reembolsando o cliente, nos casos apropriados.

Sempre que o comprador creditado para retornar o material atribuível aos mesmos defeitos técnicos, a opinião ou a sua monitorização, ou a instalação onde a pessoa foi montado pela FIT Energy, S.L. que eles confirmam, caso em que será necessário reembolsar o comprador por pagamento ou substituição gratuita do material adquirido, sem qualquer dano ou prejuízo de qualquer espécie pode ser exigido.

REIVINDICAÇÕES: a FIT Energy, S.L., não aceitará reclamações relativas a erros nos valores ou tipos recebidos pelo cliente, desde que não sejam feitas dentro de 48 horas após a data em que o fornecimento foi feito.

DIVERSOS: Para qualquer divergência que possa resultar em conformidade e interpretação das operações realizadas pela FIT Energy, S.L. e seu cliente, que renuncia expressamente à sua própria jurisdição ou legislação, se submete expressamente à jurisdição dos tribunais de vitoria-gasteiz. Estas condições revogarão quaisquer outras datas anteriores e permanecerão em vigor por um período indefinido, desde que não sejam estabelecidas novas para o mesmo fim.

*Para consultar as condições gerais de venda visite a web: <http://ecommerce.fitenergy.es/contenido/condiciones-generales>.

FILUX

ILUMINACIÓN LED PROFESIONAL

 FILUX.COM

FILUX ES UNA MARCA DE



Portal de Zurbano, 13
01013 Vitoria-Gasteiz, España.
+34 945 292 773
fitenergy.es