

LED

| Iluminación  
| Lighting  
| Iluminação

| 2023

| Catálogo  
| Catalogue  
| Catálogo

**SOLUCIONES LED PROFESIONALES**  
**PROFESSIONAL LED SOLUTIONS**  
**SOLUÇÕES PROFISSIONAIS DE LED**

**FILUX**

# ÍNDICE INDEX ÍNDICE

Fabricamos a medida  
On demand custom  
Fabricamos à medida

04

Estudios lumínicos  
Light tests  
Estudos luminotécnicos

08

Ventajas de la iluminación led  
Advantages of led lighting  
Vantagens da iluminação led

11

Terminología  
Terminology  
Terminologia

16

Situación geográfica  
Geographic situation  
Situação geográfica

05

Certificaciones  
Certifications  
Certificações

09

Sé nuestro distribuidor  
Be our distributor  
Seja nosso distribuidor

12

Temperatura de color  
Color temperature  
Temperatura de cor

18

Nuestros servicios  
Our services  
Serviços

06

Avance tecnológico  
Technological advance  
Avanço tecnológico

10

Información catálogo  
Catalogue info  
Informação do catálogo

14





Campanas  
High bays  
Campânulas

20

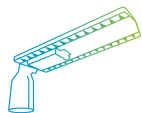

Farolas  
Streetlights  
Viárias

32



Proyectores  
Floodlights  
Projetores

47



Downlights  
Downlights  
Downlights

56



Sensores  
Sensors  
Sensores

76



Luminaria de emergencia  
Emergency luminaire  
Luminária de emergência

85



Luminaria solar  
Solar luminaire  
Luminária solar

90



Paneles  
Panels  
Painéis

94



Tubos y luminarias estancas  
Tubes and waterproof luminaires  
Tubos e luminárias estanques

100



Tiras  
Strips  
Fitas

109



Bombillas  
Bulbs  
Lâmpadas

122



Condiciones generales  
General conditions  
Condições gerais

142

## SKU

Índice de SKU  
SKU index  
Índice de SKU

145

Fabricamos à medida sob o solicitado  
On demand custom manufacturing

Fabricamos a medida sobre demanda

Los productos FILUX que están en el catálogo, son productos de alta rotación y demanda en el mercado actual. Se puede fabricar a medida bajo demanda cualquier tipo de iluminación que no esté presente en este catálogo.

The FILUX products that are in the catalogue, are products of high turnover and demand in the current market. Any type of LED lighting that is not present in this catalogue can be made to measure on demand.

Os produtos Filux apresentados são de elevada rotação, no entanto, podemos fabricar produtos com características diferentes se solicitado.

**FILUX**  
BY FIT ENERGY

# SITUAÇÃO GEOGRÁFICA

## GEOGRAPHIC SITUATION

### SITUACIÓN GEOGRÁFICA

Filux es una marca de Fit Energy y está situada geográficamente en Vitoria-Gasteiz, capital del País Vasco en España, una ciudad reconocida por la importante actividad industrial. Es una marca de economía real, que basa parte de su crecimiento en su expansión territorial. Para ello está creando una amplia red comercial y de establecimientos especializados en LEDs con firma propia o asociados.

Esta red cuenta en estos momentos con diversos puntos de venta y distribución en toda España y Portugal y así expandiéndose con varios puntos de distribución en Europa y la posibilidad de compra online a través de su web.

Filux is a Fit Energy brand is located geographically in Vitoria-Gasteiz, capital of the Basque Country in Spain, a city recognized for its important industrial activity. It is a real economy brand that bases part of its growth on its territorial expansion, for which it is creating an extensive commercial network and specialized stores in LEDs with their own firm or associates.

This network currently has various points of sale and distribution throughout Spain and Portugal and thus expanding with several distribution points in Europe and the possibility of online purchase through its website.

Filux é uma marca Fit Energy está localizada geograficamente em Vitoria-Gasteiz, capital do País Basco em Espanha e Portugal, uma cidade reconhecida pela sua importante atividade industrial. É uma marca da economia real que baseia parte de seu crescimento em sua expansão territorial, para a qual está a criar uma extensa rede comercial e especializadas em iluminação LED.

Atualmente, esta rede tem vários pontos de distribuição por Espanha, estando em franca expansão pela Europa permitindo ainda a compra online através do nosso website



# NOSSOS SERVIÇOS OUR SERVICES

## NUESTROS SERVICIOS



### Equipo | Team | Equipa

---

Nuestro equipo está compuesto por un grupo de profesionales del sector de la iluminación LED, motivados, implicados y al servicio de la innovación y la mejora continua. Contamos con departamento de Ingeniería, diseño publicidad y marketing, departamento de administración, departamento de ventas, atención al cliente y logística.

Our team is composed of a group of professionals in the LED lighting sector, motivated, involved and at the service of innovation and continuous improvement, we have engineering department, design advertising and marketing, administration department, sales department, customer service and logistics.

A nossa equipa é constituída por um grupo de profissionais do sector de iluminação LED, fortemente motivados e com forte empenho no serviço de inovação e melhoria contínua. Dispomos departamento de engenharia, publicidade de design e marketing, departamento de administração, departamento de vendas, Atenção ao cliente e logística.



### Soluciones | Solutions | Soluções

---

Contamos con distintos departamentos para brindar las soluciones que puedan surgir, como asesoramiento técnico y personalizado a nuestros clientes, un equipo de atención al cliente siempre dispuesto a resolver tus dudas y un equipo logístico para hacer que los pedidos lleguen cuando lo necesites entre otros servicios.

We have different departments to provide solutions that may arise, such as technical advice and personalized to our customers, a customer service team which is always willing to answer your questions and logistics team to place orders when you need it among other services .

Temos diferentes departamentos para fornecer várias soluções que possam surgir, tais como, apoio técnico, personalizado, uma equipa de atendimento ao cliente sempre disponível para responder a todas as questões e uma equipa de logística para dar seguimento às encomendas.



## Garantía | Warranty | Garantia

FILUX, garantiza entre dos y cinco años, a partir de la fecha de compra, el funcionamiento de sus productos contra cualquier defecto en los materiales. Nuestra garantía incluye la reparación, reposición, o cambio del producto y/o componentes sin cargo alguno para el cliente.

Filux warranties are between 2 and 5 years from the day of the purchase, the performance of their products against any defect of the materials. Our warranties includes the reparations, replacement or change of any product and/or their components without any additional charge to the client.

As nossas garantias são de 2 e 5 anos a partir da data de compra, contra qualquer defeito de fabrico. As nossas garantias incluem reparações, substituição ou alteração de qualquer produto e / ou seus componentes sem qualquer custo adicional para o cliente.



## Puntos de distribución | Distribution points | Pontos de distribuição

Filux irrumpió en un mercado que necesitaba productos de iluminación LED, que cumplieran con innovación, alta calidad y precio competitivo. 5 años más tarde, Filux consolida su posición como punto de referencia en España y Portugal y expande sus negocios al resto de Europa, representado en países como Francia, Italia, Inglaterra y Polonia.

Filux erupted in a market in need of LED products that accomplished innovation, high quality and a competitive price. Five years later, Filux consolidated their position as a reference point in Spain and Portugal. And it expands their business to the rest of Europe, being represented in countries such as France, Italy, the UK and Poland.

A Filux entrou num mercado que procura produtos de iluminação LED que atendam a inovação, alta qualidade e preço competitivo. Após 5 anos a Filux consolida a sua posição no mercado como uma empresa de referência no mercado Espanhol, e Português estando-se a expandir para o resto da Europa, tendo actualmente representações em França, Itália, Inglaterra e Polónia.



## Servicio postventa | After-sales service | Serviço pós-venda

Contamos con servicio post venta rápido y de calidad, ya sea asesoramiento telefónico para instalación o, si los productos lo requieren, servicio de instalación. Nuestros empleados están capacitados para atender incidencias, escuchar al cliente, y brindar la mejor solución.

We have a fast and quality after-sales service, whether it's telephone advice for installation or if the products require installation service, our employees are trained to attend incidents, help the customer, and provide the best solution.

Temos um serviço de pós venda rápido de elevada qualidade, onde apoiamos e esclarecemos todas as dúvidas que os nossos clientes nos apresentam a cerca dos nossos produtos. A nossa equipa comercial dispõem de elevada formação técnica que permite solucionar os problemas ou dúvidas e aconselhar sobre qual a melhor solução para cada caso.

# ESTUDOS LUMINOTÉCNICOS LIGHT TESTS

## ESTUDIOS LUMÍNICOS

En nuestras instalaciones de Vitoria-Gasteiz, en España, contamos con profesionales y equipos altamente especializados, como nuestro espectrómetro, un gran instrumento que mide distintos datos de nuestras luminarias, así como la temperatura de color, flujo luminoso, índice de distribución de color, parámetros eléctricos, fotometrías y colorimetrías.

In our facilities of Vitoria-Gasteiz, in Spain, we have professionals and highly specialized equipment, like our spectrometer, a great instrument that measures different data from our luminaires, like color temperature, luminous flux, color distribution index, electrical parameters, photometry and colorimetry.

Nas nossas instalações em Vitoria-Gasteiz, Espanha, dispomos de uma equipa de profissionais e de equipamentos altamente sofisticados, como o nosso espectrómetro, um instrumento que mede diferentes dados das nossas luminárias, bem como a temperatura da cor, fluxo luminoso, índice de distribuição de cores, parâmetros elétricos, fotometria e colorimetria, entre outros..





# CERTIFICAÇÕES

# CERTIFICATIONS

# CERTIFICACIONES

## RoHS

El certificado ROHS (Restriction of Hazardous Substances), garantiza la restricción de ciertas sustancias peligrosas en aparatos eléctricos y electrónicos. Pretende promover el reciclaje, la reutilización y la recuperación de los residuos de estos equipos para reducir su contaminación.

The ROHS certificate (Restriction of Hazardous Substances) guarantees the restriction of certain dangerous substances on electrical and electronic appliances. Its objective is to promote the recycle and recovery of the waste from these equipments to reduce their pollution.

O certificado ROHS (Restrição de Substâncias Perigosas) garante a restrição de certas substâncias perigosas em equipamentos elétricos e eletrônicos. O objetivo é promover a reciclagem, reutilização e recuperação de resíduos desses equipamentos por forma a reduzir a contaminação.



Para poder venderse en el Espacio Económico Europeo, muchos productos deben llevar obligatoriamente el marcado CE, que constituye la prueba de que el producto se ha evaluado y cumple los requisitos de seguridad, sanidad y protección del medio ambiente exigidos por la UE.

To be able to sell in the European Economic area they must carry the CE mark, this constitutes the proof that this product was evaluated and it complies with the requirements of security, health and protection of the environment required by the EU.

Para podermos vender os nossos produtos no espaço Económico Europeo, os produtos devem ter a marca CE, que funciona como prova de que o produto foi avaliado e cumpre os requisitos de segurança, saúde e proteção ambiental exigidos pela UE.



Entidad Nacional de Acreditación (Gov. de España). La certificación ENAC acredita el cumplimiento de los productos de la normativa vigente garantizando los resultados técnicos de las luminarias. Certificación disponible en algunos productos.

Entidad Nacional de Acreditación (Government of Spain). ENAC certification accredits compliance with the products of current regulations guaranteeing the technical results of the luminaires. Certification available on some products.

Entidad Nacional de Acreditación (Governo da Espanha). A certificação ENAC credencia a conformidade com os produtos das normas vigentes, garantindo os resultados técnicos das luminárias. Certificação disponível em alguns produtos.



Fundación eco-raee's es un Sistema Integrado de Gestión de Residuos de Aparatos Eléctricos y Electrónicos. Fundación eco-raee's representa a FIT Energy ofreciendo cobertura y asesoramiento en materia de recogida, traslado, almacenamiento y tratamiento de los residuos de aparatos eléctricos y electrónicos.

Eco-raee's foundation is an Integrated Waste Management System for Electrical and Electronic Equipment. Eco-raee's foundation represents FIT Energy offering coverage and advice on the collection, transfer, storage and treatment of waste electrical and electronic equipment.

Eco-raee's foundation é um Sistema Integrado de Gerenciamento de Resíduos de Equipamentos Elétricos e Eletrônicos. A eco-raee's foundation representa a FIT Energy, oferecendo cobertura e aconselhamento sobre a coleta, transferência, armazenamento e tratamento de resíduos de equipamentos elétricos e eletrônicos.

# AVANÇO TECNOLÓGICO TECHNOLOGICAL ADVANCE AVANCE TECNOLÓGICO

La tecnología LED posee un alto potencial para mejorar nuestra calidad de vida; gracias a los más recientes avances tecnológicos, nuestro departamento técnico adapta a la perfección los diseños para su fabricación, haciendo mejor y más duraderos nuestros productos, permitiendo tener menor mantenimiento, más resistencia a los golpes, mejor eficiencia energética... es decir, estos avances nos permiten el desarrollo de productos LED cada vez más innovadores.

LED technology has a high potential to improve our life's quality, thanks to the latest technologies, our technical department perfectly adapts the designs for its manufacture, making better and more durable our products, less maintenance, more resistance to shocks, improving its energy efficiency, it means, these advances allow us to develop increasingly innovative LED products.

A tecnologia LED tem um elevado potencial para melhorar a nossa qualidade de vida, graças aos mais recentes avanços tecnológicos. O nosso departamento técnico adapta perfeitamente os nossos produtos para que na fase de fabricação, os torne com melhor desempenho bem como mais durabilidade, permitindo menos manutenção, maior resistência a choques, melhorando sua eficiência energética, ou seja, desenvolver produtos led cada vez mais inovadores.



# VANTAGENS DA ILUMINAÇÃO LED

## ADVANTAGES OF LED LIGHTING

## VENTAJAS DE LA ILUMINACIÓN LED

Quando hablamos de las ventajas de la iluminación LED nos referimos a que el consumo de electricidad es mínimo, con un 80% de ahorro de energía y una duración de unas 10 veces más que una bombilla tradicional, siendo su vida útil de entre 30.000 y 70.000 horas dependiendo del producto. Son más resistentes a las temperaturas y generan mínima emisión de calor.

Usar tecnología LED es una alternativa sustentable, ecológica y eficiente.

When talking about the advantages of LED lighting we mean that the consumption of electricity is minimal, with savings of 80% energy, duration of about 10 times more than a traditional bulb, being its useful life between 30,000 and 70,000 hours depends on the product. They are more resistant to temperatures and generate minimal heat emission.

Using LED technology is a sustainable, ecological and efficient alternative.

Quando falamos sobre as vantagens da iluminação de LED afirmamos que o consumo de eletricidade é mínimo, com uma poupança de 80% de energia e uma duração de 10 vezes mais que uma lâmpada tradicional, atendendo uma vida útil de 30.000 a 70.000 horas.

Utilizar tecnologia LED é uma alternativa sustentável, ecológica e eficiente.

# SEJA NOSSO DISTRIBUIDOR BE OUR DISTRIBUTOR SÉ NUESTRO DISTRIBUIDOR

Queremos que trabajes con nosotros, ser más competitivos en el sector de la iluminación, y para ello te presentamos nuestro catálogo de suministros LED.

Al trabajar con nosotros podrás realizar mejores presupuestos en tus instalaciones y beneficiarte de numerosas ventajas.

We want you to work with us, to be more competitive in the LED lighting market, and for that we present you our catalogue of LED supplies.

When working with us you will be able to realize better budgets for your installations and benefit from numerous advantages.

Gostariamos que fosse nosso parceiro de negócio, ser mais competitivo no sector de iluminação e por esse motivo apresentamos o nosso catálogo de iluminação LED.

Ao ser nosso parceiro, irá ter maior facilidade na execução de propostas comerciais além de ir beneficiar de inúmeras vantagens.



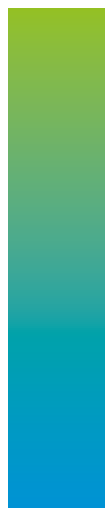

# INFORMAÇÃO CATÁLOGO

## CATALOGUE INFO

## INFORMACIÓN CATÁLOGO

Dentro de este catálogo, podrás ver distintos iconos que explicamos a continuación.

Within this catalogue, you will see different icons explained below.

Neste catálogo, serão apresentados símbolos diferentes que explicaremos de seguida.

Vida útil  
Useful life  
Vida útil



50.000H

Lúmenes/vatios  
Lumens/watts  
Lúmenes/watt



160LM/W

Compatible con NEMA  
NEMA Compliant  
Em conformidade com NEMA



NEMA  
Compatible

Protección IP  
IP protection  
Proteção IP



IP65

Tipo de LED  
LED type  
Tipo de LED

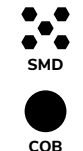

FILAMENT

Cambio color de temperatura  
Color temperature switch  
Mudar a temperatura de cor



ALL IN ONE

Chip  
Chip  
Chip



LUMILEDS



IK08



Protección IK  
IK protection  
Proteção IK

CRI

>80



Índice de reproducción cromática  
Color rendering index  
Índice de reprodução cromática



E27



Conector  
Connector  
Casquilho

PF

>0,95



Factor de potencia  
Power factor  
Fator de potência

5

YEAR  
WARRANTY



Garantía  
Warranty  
Garantia



MOTION  
SENSOR



Sensor de movimiento  
Motion sensor  
Sensor de movimento



1-10 V

















Regulación  
Regulation  
Regulação

# Nossos símbolos

## Our icons

## Nuestros iconos

Driver Driver Transformador	Regulación del tiempo Time dimming Temporizador	Ángulo de apertura Beam angle Ângulo de abertura	Temperatura de trabajo Working temperature Temperatura de trabalho	Dimensiones Dimensions Dimensões	Unidades por embalaje Units per pack Unidades por embalagem	Precio Price Preço
						
MEANWELL	TIME DIMMING	120°	W.TEMP	DIMENSIONS	100 PCS	
						
SHAPE	POWER	4KV	W	UGR <19	LUMENS	ADJUSTABLE
Forma Shape Forma	Energía Power Potência	Protección contra sobretensión Surge protection Proteção contra sobretensão	Vatios Watts Watts	Índice de deslumbramiento unificado Unified glare rating Classificação de brilho unificado	Lúmenes Lumens Lúmenes	Dirección de posición ajustable Adjustable position direction Direção da posição ajustável

# TERMINOLOGIA

# TERMINOLOGY

# TERMINOLOGIA

## ESP

**LÚMENES:** Es la intensidad luminosa uniforme repartida en un ángulo sólido de un estereorradián y su flujo luminoso total emitido en esta dirección se llama lumen. Una manera más sencilla de definir lumen sería decir que es la cantidad total de luz visible en una dirección o ángulo proyectada sobre una superficie.

**LM/W:** Lúmenes emitidos por cada vatio de electricidad.

**WATIO:** Unidad de medida de potencia.

## EN

**LUMENS:** It is the uniform luminous intensity distributed in a solid angle of a steradian and its total luminous flux emitted in this direction is called lumen. A simpler way to define lumen would be to say that it is the total amount of light visible in a direction or angle projected onto a surface.

**LM/W:** This calculation indicates the amount of lumens emitted per watt of electricity.

**WATT:** Unit of measurement of power.

## PT

**LUMENS:** é a unidade de medida de fluxo luminoso. Um lúmen é o fluxo luminoso total emitido em uma direção ou ângulo projectado em uma superfície.

**LM / W:** esta unidade de medida indica o número de lúmenes emitidos por watt de eletricidade.

**WATT:** unidade de medida de potência.

**EQUIVALENCIA EN WATIOS:** Es la comparativa entre Watios/Lúmenes de una bombilla convencional aplicada a la tecnología LED.

**VOLTAJE / FRECUENCIA:** El voltaje es la fuerza que impulsa los electrones. La frecuencia es el número de veces que se repite la señal en un determinado tiempo. Ambos son componentes de la corriente alterna.

**CRI:** El CRI o Índice de Reproducción Cromática es una medida de la capacidad que una fuente luminosa tiene para reproducir fielmente los colores de varios objetos en comparación con una fuente de luz natural o ideal.

**EQUIVALENCE IN WATTS:** It is the comparison between watts / lumens of a light bulb applied to LED technology.

**VOLTAGE / FREQUENCY:** Voltage is the force that drives the electrons. The frequency is the number of times the signal is repeated in a certain time. Both are components of the alternating current.

**CRI:** The CRI or Chromatic Reproduction Index is a measure of the ability of a light source to faithfully reproduce the colors of various objects compared to a natural or ideal light source.

**EQUIVALÊNCIA EM WATTS:** é a comparação entre watts / lumens de uma lâmpada aplicada à tecnologia LED.

**TENSÃO / FREQUÊNCIA:** a tensão é a força que impulsiona os elétrons. A frequência é o número de vezes que o sinal é repetido em um determinado tempo. Ambos são componentes da corrente alternada.

**CRI:** o cri ou índice de reprodução de cores é uma medida da capacidade de uma fonte de luz para reproduzir com exatidão as cores de vários objetos em comparação com uma fonte de luz natural ou ideal.



---

**PF:** El Factor de Potencia es el porcentaje de energía que es aprovechada por un sistema electrónico como luminarias LED, televisiones, ordenadores o cualquier aparato electrónico. Este dato es importantísimo para saber el aprovechamiento energético del equipo y determinar su calidad.

**ÁNGULO DE APERTURA:** Es un parámetro importante, especialmente en las lámparas de iluminación directa. El ángulo de apertura de luz nos indica si la lámpara iluminará un área más grande o más pequeña.

---

**PF:** The Power Factor is the percentage of energy that is taken advantage of by an electronic system such as LED luminaires, televisions, computers or any electronic device. This data is very important to know the energy use of the equipment and determine its quality.

**BEAM ANGLE:** It is an important parameter, especially in direct lighting lamps. The opening angle of light tells us if the lamp will illuminate a larger or smaller area.

**PF:** o fator de potência é a percentagem de energia que é usada por um sistema eletrônico, como luminárias led, televisões, computadores ou qualquer dispositivo eletrônico. Estes dados são muito importantes para conhecer o uso de energia do equipamento e de determinar a sua qualidade.

**ÂNGULO DE ABERTURA:** é um parâmetro importante, especialmente em lâmpadas de iluminação direta. O ângulo de abertura da luz indica se a lâmpada iluminará uma área maior ou menor.

**EMPOTRABLE:** Es una luminaria que la podremos instalar en un techo falso.

**SUPERFICIE:** Es una luminaria que la podremos instalar pegada al techo, ideales para lugares donde no hay techo falso.

**PROTECCIÓN IP:** Las características de IP indican la medida en que está protegida una lámpara de objetos, el polvo y la humedad. Las características IP constan de dos dígitos: Primer dígito: protección contra la entrada de polvo y objetos, Segundo dígito: protección contra el agua.

**RECESSED:** It is a luminaire that we can install on a false ceiling.

**SURFACE:** It is a luminaire that can be installed sticking under the ceiling, ideal for places where there is no false ceiling.

**IP PROTECTION:** The IP characteristics indicate the extent to which an object lamp, dust and moisture is protected. The IP characteristics consist of two digits: First digit: protection against the entry of dust and objects, Second digit: protection against water.

**ENCASTRAR:** é uma luminária que podemos instalar em um teto falso, encastrável.

**SUPERFÍCIE:** é uma luminária que podemos instalar de modo superfície, ideal para locais onde não há teto falso.

**PROTEÇÃO IP:** As características do IP são apresentadas por dois dígitos: primeiro dígito: proteção contra ppequenos residuos sólidos, segundo dígito: proteção contra líquidos.

# TEMPERATURA DE COR COLOR TEMPERATURE

## TEMPERATURA DE COLOR

ESP

Dos luces blancas pueden ser completamente distintas. Seguro que lo ha notado cuando, tras reemplazar una bombilla fundida (algo cada vez menos frecuente gracias a la iluminación LED), ha percibido la habitación de modo diferente. Se debe a que ha colocado una bombilla, también blanca y de la misma potencia, pero con distinta temperatura de color.

La temperatura de color podría definirse como la sensación que percibe el ojo humano ante una luz, siendo cálida si predomina el color ámbar o fría si predomina el azul. Esta medición solo se aplica a la luz blanca y técnicamente se define como "la impresión de color a ciertas temperaturas de un radiador de cuerpo negro perfecto", según la guía de la Federación de Asociaciones Europeas de Luminarias y Componentes para Luminarias.

El concepto es más simple de lo que parece. Piense en un hierro incandescente al que se le va aplicando cada vez más calor. Cuando su temperatura se sitúa a unos 1.000 K (grados kelvin) adquiere una tonalidad rojiza. Si la temperatura sube hasta situarse entre 2.000 y 3.000 K su color se vuelve amarillento. A 4.000 K su tono es blanco neutro y entre 5.000 y 7.000 K blanco frío. Sin embargo, cuando hablamos de luz, la "temperatura" es sólo una medida relativa: no tiene que ver con el calor físico sino con la sensación que produce en el ojo humano.

EN

Two white lights can be completely different. Surely you have noticed when, after replacing a fused light bulb (something less and less frequent thanks to LED lighting), you have perceived the room differently. It is because you have placed a bulb, also white and of the same power, but with different color temperature.

The color temperature could be defined as the sensation that the human eye perceives about a light, being warm if the amber prevails or cold color if the blue predominates. This measurement only applies to white light and is technically defined as the "color printing at certain temperatures of a perfect black body radiator", according to the guide of the Federation of European Luminaires and Components Associations for Luminaires.

The concept is simpler than it seems. Think of an incandescent iron that is getting more and more heat. When its temperature is about 1,000 K (Kelvin degrees) it takes on a reddish hue. If the temperature rises to between 2,000 and 3,000 K its color turns yellowish. At 4,000 K its tone is neutral white and between 5,000 and 7,000 K cold white. However, when we speak of light, "temperature" is only a relative measure: it has nothing to do with physical heat but with the sensation it produces in the human eye.

PT

Duas luzes brancas podem ser completamente diferentes. Certamente já notou que, depois de substituir uma lâmpada fundida (algo cada vez menos frequente graças à iluminação por LED), o ambiente apresenta-se de forma diferente. É porque colocou uma lâmpada, também branca e com a mesma potência, mas com temperatura de cor diferente.

A temperatura de cor pode ser definida como a sensação percebida pelo olho humano antes de uma luz, sendo quente se âmbar ou frio se predominar, a cor azul. Esta medição aplica-se apenas à luz branca e é tecnicamente definida como "a emissão de cores a determinadas temperaturas de um corpo negro radiador", de acordo com o guia da federação de associações de componentes e luminárias europeias.

O conceito é mais simples do que parece. Pense num ferro incandescente ao qual se vai aplicando mais e mais calor. Quando sua temperatura está em torno de 1.000 k (graus kelvin), ela adquire uma tonalidade avermelhada. Se a temperatura subir entre 2.000 e 3.000 K, a sua cor fica amarelada. Aos 4.000 k seu tom é branco neutro e entre 5.000 e 7.000 K branco frio. No entanto, quando falamos de luz, "temperatura" é apenas uma medida relativa: não tendo nenhuma relação com o calor físico, mas com a sensação que produz no olho humano.

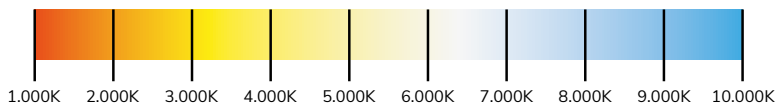



**Produtos**  
**Products**  
**Productos**



020-031



Campanas  
High bays  
Campânulas



020-031



Campanas  
High bays  
Campânulas

032-046



Farolas  
Streetlights  
Viárias

047-055



Proyectores  
Floodlights  
Pojetores

056-075



Downlights  
Downlights  
Downlights

076-084



Sensores  
Sensors  
Sensores

085-089



Lum. emergencia  
Emergency lum.  
Lum. emergência

## LED PRO UFO HIGH BAY. Meanwell

La campana LED PRO UFO Filux cuenta con un diseño exclusivo y compacto que permite disipar el calor de forma constante y eficaz. Las Campanas LED PRO UFO Filux están fabricadas según los estándares de calidad más exigentes y ofrecen una garantía de 5 años. Las Campanas LED PRO UFO Filux presentan una gran resistencia.

Industrial LED PRO UFO high bays by Filux boasts a unique and compact design allowing to dissipate heat efficiently and constantly. LED PRO UFO Filux High bays are manufactured to the highest quality standards and offer a 5 year warranty. LED PRO UFO Filux High bays have a great resistance.

A campânula LED PRO UFO Filux tem um design exclusivo e compacto que dissipa o calor de maneira constante e eficaz. As campânulas LED PRO UFO Filux são fabricados atendendo aos mais altos padrões de qualidade e oferecem uma garantia de 5 anos. As câmpanulas Filux LED PRO UFO são muito resistentes.

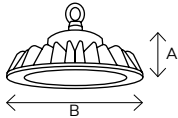

**5**  
YEAR  
WARRANTY

**50.000H**

**CRI**

>80

**120°**

**MEANWELL**

**PF**

>0,95

**IP65**

**4KV**

**IK09**

**LUMILEDS**

**-40° | +60°**

**1 PCS**



Model	Sku	mm	Kg	Power	C.Temp	LM/W	Lumens	Input	Reg.	€*
-------	-----	----	----	-------	--------	------	--------	-------	------	----

A B

\*Ecoraee incluida | included | incluída

\* IVA no incluido | VAT not included | IVA não incluído

FT-6100	F6018	191,40	Ø 320	4	100W	5.000K	160	100-240V, 50/60Hz	0-10V	273,03 €	
FT-6150	F6019	193,88		4,3	150W					24000	308,13 €
FT-6200	F6020	198,50		4,4	200W					32.000	378,26 €
FT-6300	F6021	204,5	Ø 400	5	300W	150	45.000			539,15 €	

090-093

Luminaria solar  
Solar luminaire  
Luminária solar

094-099

Paneles  
Panels  
Painéis

100-108

Tubos  
Tubes  
Tubos

109-121

Tiras  
Strips  
Fitas

122-140

Bombillas  
Bulbs  
Lâmpadas



## Fotometría | Photometry | Fotometria

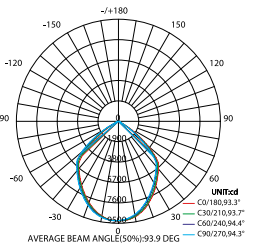
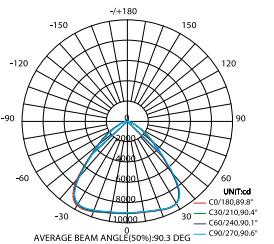
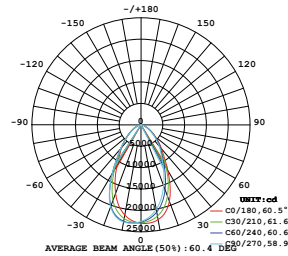
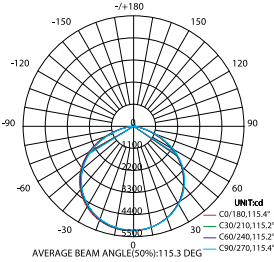

020-031



Campanas  
High bays  
Campânulas

032-046



Farolas  
Streetlights  
Viárias

047-055



Proyectores  
Floodlights  
Pojetores

056-075



Downlights  
Downlights  
Downlights

076-084



Sensores  
Sensors  
Sensores

085-089



Lum. emergencia  
Emergency lum.  
Lum. emergência

## LED PRO UFO HIGH BAY. Meanwell

### Accesorios | Accessories | Acessórios

\*Ecorae incluida | included | incluída

\* IVA no incluido | VAT not included | IVA não incluído



FT-6000/F6010

44,21 €\*  

---

Kit base + sensor luz diurna  
Base kit + daylight sensor  
Kit base + sensor de luz



FT-6000/F6011

123,77 €\*  

---

Kit base + sensor de movimiento  
Base kit + motion sensor  
Kit base + Sensor de movimento



FT-3000/F3015

28,09 €\*  

---

Protector sobre tensión Philips SP1  
Philips voltage protector SP1  
Protetor contra sobretensões Philips SP1



FT-6000/F6028

10,21 €\*  

---

Lente ángulo de apertura 60°  
60° beam angle lens  
Lente ángulo de abertura de 60°

Para/for:  
F6018  
F6019  
F6020



FT-6000/F6029

10,21 €\*  

---

Lente ángulo de apertura 90°  
90° beam angle lens  
Lente ángulo de abertura de 90°

Para/for:  
F6018  
F6019  
F6020



FT-6000/F6513

86,95 €\*  

---

Cubierta reflectora  
Reflective cover  
Cobertura reflectora  
(Pc 90° Ugr19 UFO)

Ø  
480mm



FT-6000/F6027

16,67 €\*  

---

Soporte ajustable superficie  
Surface adjustable support  
Suporte superficie ajustável

Para/for:  
F6018  
F6019  
F6020



FT-6000/F6032

61,88 €\*  

---

Convertor DALI - 1/10V  
DALI converter - 1/10V  
Convertor DALI - 1/10V



FT-2000/F2051

4,72 €\*  

---

Conector  
Connector  
Ligador

IP68



FT-2000/F2052

13,15 €\*  

---

Caja conexión 3 salidas  
Connection box 3 outputs  
Caixa de ligação 3 saídas



FT-6000/F6031

436,55 €\*  

---

Kit de emergencia  
Emergency kit  
Kit de emergência

Para/for:  
F6018  
F6019  
F6020  
F6021





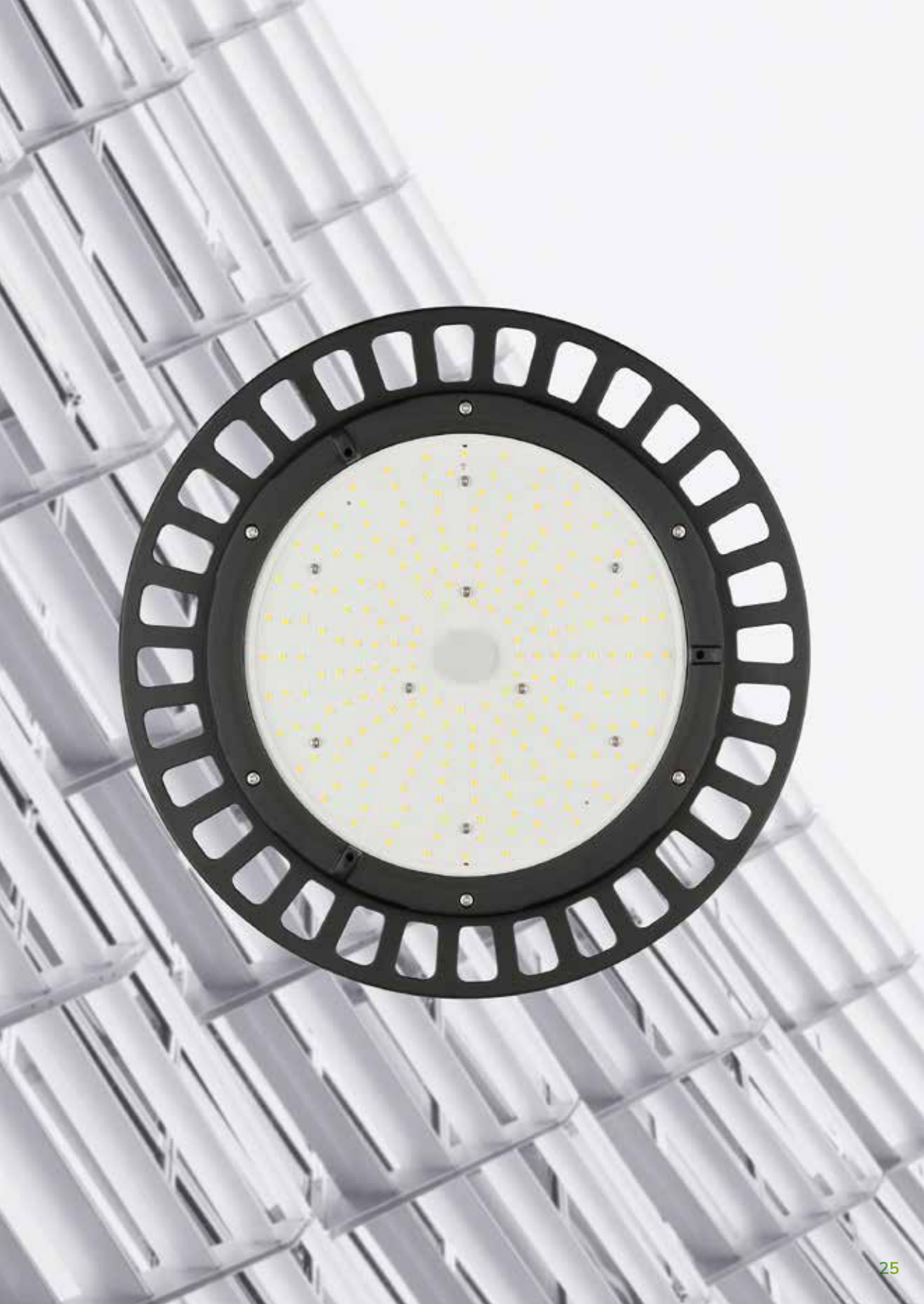



## LED PRO UFO HIGH BAY. Philips

Las campanas LED PRO UFO Filux F6043, F6044, F6045 cuentan con Driver Philips y con un diseño exclusivo y compacto que permite disipar el calor de forma constante y eficaz. Las Campanas LED PRO UFO Filux están fabricadas según los estándares de calidad más exigentes y ofrecen una garantía de 5 años. Las Campanas LED Filux presentan una gran resistencia.

Industrial LED PRO UFO Filux F6043, F6044, F6045 high bays have a Philips driver and boasts a unique and compact design allowing to dissipate heat efficiently and constantly. LED PRO UFO Filux High bays are manufactured to the highest quality standards and offer a 5 year warranty. LED Filux High bays have a great resistance.

As campânulas LED PRO UFO Filux F6043, F6044, F6045 têm um driver Philips e possui um design exclusivo e compacto que dissipa o calor de maneira constante e eficaz. As campânulas LED PRO UFO Filux são fabricados atendendo aos mais altos padrões de qualidade e oferecem uma garantia de 5 anos. As câmpanulas Filux LED são muito resistentes.

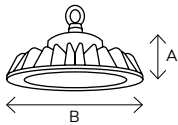

**5**  
YEAR  
WARRANTY

**50.000H**

**CRI**  
>80

**120°**



**PF**  
>0,95

**IP65**

**SP**  
4KV

**IK08**



**-40° | +65°**

**1 PCS**



Model	SKU	mm	Kg	Power	C.Temp	LM/W	Lumens	Input	Reg.	€*
		A	B							
FT-6100	F6043	184	Ø 310	2,2	100W	5.000K	16.000	220-240V, 50/60Hz	1-10V	198,15 €
FT-6150	F6044		Ø 310	2,3	150W		24.000			211,48 €
FT-6151	F6045	192	Ø 350	2,9	200W		32.000			254,29 €

\*Ecorae incluída | included | incluída  
\* IVA no incluído | VAT not included | IVA não incluído

090-093



Luminaria solar  
Solar luminaire  
Luminária solar

094-099



Paneles  
Panels  
Painéis

100-108



Tubos  
Tubes  
Tubos

109-121



Tiras  
Strips  
Fitas

122-140



Bombillas  
Bulbs  
Lâmpadas

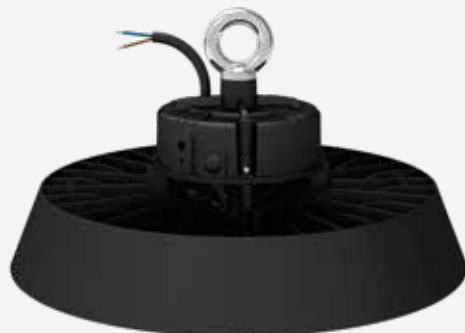

### Fotometría | Photometry | Fotometria

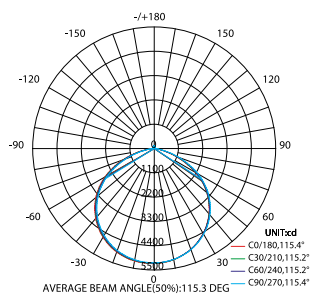

120°

Ángulo apertura  
Beam angle  
Ângulo de abertura

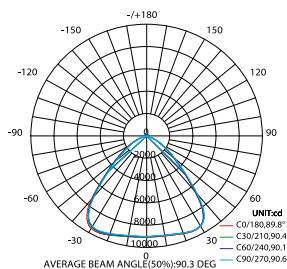

90°

Lente de ángulo apertura  
Beam angle lens  
Lente de Ângulo de abertura

020-031



Campanas  
High bays  
Campânulas

032-046



Farolas  
Streetlights  
Viárias

047-055



Proyectores  
Floodlights  
Pojetores

056-075



Downlights  
Downlights  
Downlights

076-084



Sensores  
Sensors  
Sensores

085-089



Lum. emergencia  
Emergency lum.  
Lum. emergência

## LED PRO UFO HIGH BAY. Philips

Accesorios | Accessories | Acessórios

\*Ecoraee incluída | included | incluída

\* IVA no incluído | VAT not included | IVA não incluído



FT-6000/F6010

44,21 €\*  
-----

Kit base + sensor luz diurna  
Base kit + daylight sensor  
Kit base + sensor de luz



FT-6000/F6011

123,77 €\*  
-----

Kit base + sensor de movimiento  
Base kit + motion sensor  
Kit base + Sensor de movimento



FT-3000/F3015

28,09 €\*  
-----

Protector sobre tensión Philips SP1  
Philips voltage protector SP1  
Protetor contra sobretensões Philips SP1



FT-2000/F2051

4,72 €\*  
-----

Conector  
Connector  
Ligador

IP68



FT-2000/F2052

13,15 €\*  
-----

Caja conexión 3 salidas  
Connection box 3 outputs  
Caixa de ligação 3 saídas



FT-6000/F6032

61,88 €\*  
-----

Conversor DALI - 1/10V  
DALI converter - 1/10V  
Conversor DALI - 1/10V



FT-6000/F6046

16,67 €\*  
-----

Soporte ajustable de superficie: F6043-44  
Base kit + daylight sensor: F6043-44  
Montagem superfície ajustável: F6043-44



FT-6000/F6047

10,21 €\*  
-----

Óptica 60° para UFO F6043-44  
60° beam angle lens for F6043-44  
Kit base + sensor de luz para: F6043-44



FT-6000/F6048

10,21 €\*  
-----

Óptica 90° para UFO F6043-44  
90° beam angle lens for F6043-44  
Lente ângulo de abertura 60°: F6043-44



FT-6000/F6049

16,67 €\*  
-----

Soporte ajustable de superficie: F6045  
Base kit + daylight sensor: F6045  
Montagem superfície ajustável: F6045



FT-6000/F6050

10,21 €\*  
-----

Óptica 60° para UFO F6045  
60° beam angle lens for F6045  
Kit base + sensor de luz para: F6045



FT-6000/F6051

10,21 €\*  
-----

Óptica 90° para UFO F6045  
90° beam angle lens for F6045  
Lente ângulo de abertura 60°: F6045



020-031



Campanas  
High bays  
Campânulas

032-046



Farolas  
Streetlights  
Viárias

047-055



Projectores  
Floodlights  
Pojetores

056-075



Downlights  
Downlights  
Downlights

076-084



Sensores  
Sensors  
Sensores

085-089



Lum. emergencia  
Emergency lum.  
Lum. emergência

## LED PRO LINEAR HIGH BAY

Las Campanas Lineales LED Filux son el remplazo ideal de las tradicionales luminarias de vapor de sodio o mercurio de alta presión. Aporta un ahorro energético y permite reducir los costes de mantenimiento. No tienen elementos altamente contaminantes como el mercurio siendo totalmente ecológica.

The Filux LED Linear high bays are ideal replacement for traditional high pressure mercury or sodium vapor lamps. It provides energy savings and reduces maintenance costs. It does not have highly polluting elements like mercury being, totally ecological.

As campânulas lineares de LED Filux permitem a substituição ideal das luminárias tradicionais de vapor de sódio ou demercúrio de alta pressão. Permitem uma forte poupança de energia permitindo forte redução nos custos de manutenção. Não têm componentes altamente poluentes, tais como o mercúrio sendo totalmente ecológico.



5  
YEAR  
WARRANTY

50.000H

CRI  
>70

80°x120°

MEANWELL

PF  
>0,9

0-10V



IP66



4KV



IK08



140LM/W



LUMILEDS



SMD



1 PCS



Model	SKU	mm			kg	Power	C.Temp	Lumens	Input	€*
		A	B	C						
FT-4710	F4720	355	153	136	2,5	100W	5.000K	14.000	100-277V 50/60HZ	251,09 €
FT-4715	F4721	685			4,6	150W		21.000		315,60 €
FT-4720	F4722	685			5,0	200W		28.000		364,55 €

\*Ecoraee incluida | included | incluída  
\* IVA no incluido | VAT not included | IVA não incluído

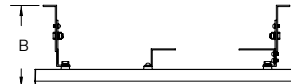
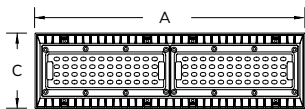

090-093

Luminaria solar  
Solar luminaire  
Luminária solar

094-099

Paneles  
Panels  
Painéis

100-108

Tubos  
Tubes  
Tubos

109-121

Tiras  
Strips  
Fitas

122-140

Bombillas  
Bulbs  
Lâmpadas

150-200W



## Fotometría | Photometry | Fotometria

### 80° x 120°

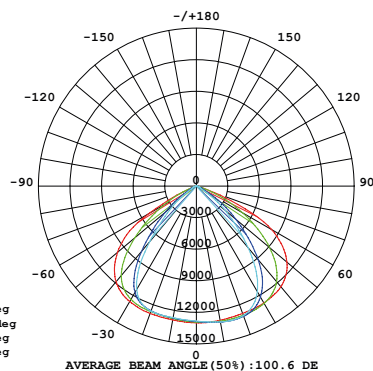
Lente de ángulo apertura  
Beam angle lens  
Lente de Ângulo de abertura

## Accesorios | Accessories | Acessórios

\*Ecorae incluida | included | incluída

\* IVA no incluido | VAT not included | IVA não incluído



FT-6000/F6032

61,88 €\*  

---

Convertor DALI - 1/10V  
DALI converter - 1/10V  
Convertor DALI - 1/10V

FT-2000/F2051

4,72 €\*  

---

Conector  
Connector  
Ligador

IP68



FT-2000/F2052

13,15 €\*  

---

Caja conexión 3 salidas  
Connection box 3 outputs  
Caixa de ligações 3 saídas

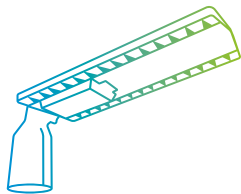

032-046



Farolas  
Streetlights  
Viárias







## LED PRO STREETLIGHT.

Reemplazo perfecto para luces viales, con lentes de cristal ópticamente optimizados y cavidades ópticas selladas IP66. Uniformidad en la luz, máxima eficiencia y reduce las emisiones de CO2. Las Farolas LED PRO están fabricadas según los estándares de calidad más exigentes, presentan una gran resistencia a las condiciones meteorológicas extremas y ofrecen una garantía de 5 años.

Perfect replacement for road lights, with optically optimized glass lenses and IP66 sealed optical cavities. Uniformity in light, maximum efficiency and reduces CO2 emissions. The PRO LED Streetlights are manufactured according to the most demanding quality standards, have a great resistance to extreme weather conditions and offer a 5 year warranty.

Substituição perfeita para iluminação pública, com lentes de vidro ópticamente optimizadas e cavidades ópticas seladas IP66. Uniformidade de luz, máxima eficiência e redução de emissões de CO2. Os postes de iluminação LED PRO são fabricados de acordo com os mais exigentes padrões de qualidade, tendo grande resistência ás condições meteorológicas extremas e oferecem uma garantia de 5 anos.



**5**  
YEAR  
WARRANTY

**50.000H**

**CRI**  
>80

**TYPE II**

**PF**  
0,9

**SMD**

**IP66**

**4KV**

**IK08**

**140LM/W**



**NEMA**  
Compatible



Model	SKU	mm			kg	Power	C.Temp	Lumens	Input	€*
		A	B	C						

\*Ecorae incluida | included | incluída

\* IVA no incluido | VAT not included | IVA não incluído

FT-3330	F3341	117	424	Ø48-60	1,1	30W	4.000K	4.200	220-240V, 50/60Hz	115,44 €
FT-3360	F3342	155	494		1,5	60W		8.400		170,83 €
FT-33100	F3343	200	623		2,4	100W		14.000		253,82 €

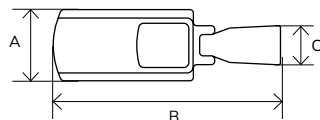

090-093

094-099

100-108

109-121

122-140

Luminaria solar  
Solar luminaire  
Luminária solar

Paneles  
Panels  
Painéis

Tubos  
Tubes  
Tubos

Tiras  
Strips  
Fitas

Bombillas  
Bulbs  
Lâmpadas

## Fotometría | Photometry | Fotometria

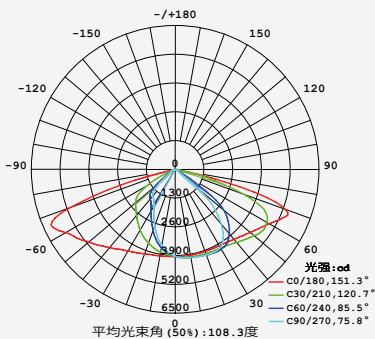

TYPE II

Ángulo apertura  
Beam angle  
Ângulo de abertura



## Accesorios | Accessories | Acessórios

\*Ecorae incluida | included | incluída

\*IVA no incluido | VAT not included | IVA não incluído



FT-6000/F6032

61,88 €\*

---

Convertor DALI - 1/10V  
DALI converter - 1/10V  
Convertor DALI - 1/10V



FT-2000/F2051

4,72 €\*

---

Conector  
Connector  
Ligador

IP68



FT-2000/F2052

13,15 €\*

---

Caja conexión 3 salidas  
Connection box 3 outputs  
Caixa de ligações 3 saídas

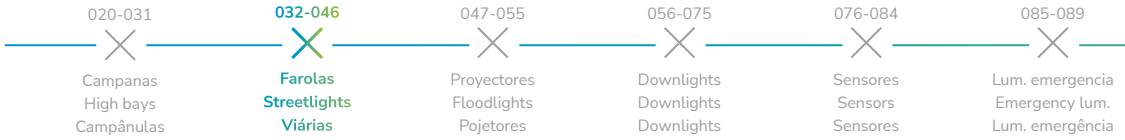

# LED PRO STREETLIGHT. ACCESORIES

\*Ecoraee incluída | included | incluída \* IVA no incluido | VAT not included | IVA não incluído

## STEP DIMMING CONTROLLER

FT-3000 F3346	Input voltage	AC85~265V, 50/60Hz	25,07*€
	Output voltage	AC85~265V, 50/60Hz	
	Dimming	0-10V dimming	
	Max. Current	10A	
	Standby power consumption	<2W	
	Interface	STANDARD NEMA 5-PIN	
	IP Rating	IP66	



### 1. Modo de control de fotocélula (controlador de iluminación con interruptor de encendido/apagado automático):

Después de instalar la luminaria, en estado de encendido:

Si la fotocélula detecta una iluminancia ambiente < 20 lux (valor de configuración por defecto), encenderá la fuente de alimentación al controlador LED para que se encienda al 100%,

Si la fotocélula detecta la iluminancia ambiente > 200 lux (valor de configuración predeterminado), apagará la fuente de alimentación del controlador LED, haciendo que la lámpara entre en estado de espera.

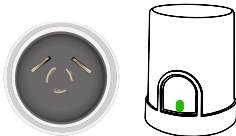

#### Preset timer task:

- Step 1: 3 Hours 100%
- Step 2: 2 Hours 80%
- Step 3: 4 Hours 60%
- Step 4: 4 Hours 80%

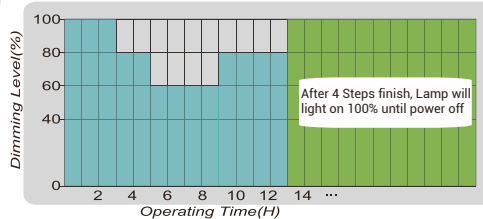

### 2. Modo de control de atenuación del temporizador de 4 pasos: (Modo preestablecido por fabricación)

Una vez instalada la luminaria, una vez **encendida\***, el programa del temporizador comienza a cronometrar y ejecuta el paso 1, la lámpara se encenderá en el nivel de atenuación preestablecido (%) para tiempo de funcionamiento preestablecido (H).

Después del paso 1, cambie automáticamente al paso 2, 3, 4.

Una vez finalizados estos 4 pasos, el programa del temporizador finalizará y la lámpara volverá al 100 % luz encendida hasta que se **apague\***

En cualquier estado, puede usar el panel de control remoto infrarrojo para configurar el tiempo de funcionamiento y la atenuación Nivel de los 4 escalones.

\* **Encendido/apagado:** se puede encender/apagar manualmente en el gabinete de distribución de energía, o encender/apagar automáticamente mediante el control de la fotocélula

## INFRARED REMOTE CONTROL PAD

Control distance >15m

FT-3000 F3347		Photocel control+4-Step timer dimming control	2,52*€
		4-Step timer dimming control	
		Photocell control	
		Turn off the light	



090-093

Luminaria solar  
Solar luminaire  
Luminária solar

094-099

Paneles  
Panels  
Painéis

100-108

Tubos  
Tubes  
Tubos

109-121

Tiras  
Strips  
Fitas

122-140

Bombillas  
Bulbs  
Lâmpadas

## CONTROLADOR ZIGBEE PARA TELEGESTIÓN

\*Ecorae incluida | included | incluída \* IVA no incluido | VAT not included | IVA não incluído

FT-3000  
F3348

Standard NEMA 5-PIN interface

Remotely turn ON/OFF, built-in 16A relay

Photocell auto control.

It supports dimming interface: DALI and 0-10V

It supports remote reading of electricity data: current, voltage, power, power factor and consumed energy

It supports recording total energy consumed and resetting

Lamp failure detection and automatic reporting to the server

Optional module: GPS, tilt and RTC

228,79\*€



## ZIGBEE GATEWAY PARA TELEGESTIÓN

\*Ecorae incluida | included | incluída \* IVA no incluido | VAT not included | IVA não incluído

FT-3000  
F3349

96-264V AC input

Network indicator

Support GPRS/4G and Ethernet communication mode

Support Zigbee transmission (2.4G or 915M), MESH route

Power consumption, 2G&4G mode ≤ 30W.

Firmware upgrading: online or cable

Built-in RTC, support local scheduled task

Optional configuration: GPS

ll-in-one waterproof aluminum case

2.855,16\*€



## ZIGBEE CONCENTRATOR PARA TELEGESTIÓN

\*Ecorae incluida | included | incluída \* IVA no incluido | VAT not included | IVA não incluído

FT-3000  
F3350

CD display

Micro-controller of high-performance 32-bit industrial-grade ARM9 CPU

Based on Linux system which is a highly reliable embedded platform.

With interface of 10/100M Ethernet, RS485, USB, etc

It supports GPRS & Ethernet remote communication methods

Upgrading locally/remotely: USB disk/Ethernet, GPRS

It is able to read electric energy remotely by built-in smart meters or external meters

Built-in 4 DO, 8 DI (6DC IN+2AC IN)

Fully sealed housing, strong anti-interference of high frequency signal ability and with standing high voltage, lightning

4.538,11\*€



020-031 Campanas High bays Campânulas	<b>032-046</b> Farolas Streetlights Viárias	047-055 Proyectores Floodlights Pojetores	056-075 Downlights Downlights Downlights	076-084 Sensores Sensors Sensores	085-089 Lum. emergencia Emergency lum. Lum. emergência
--	--	--	---	--	---

## STREETLIGHT HEAD ECA

Cuerpo para luminaria ECA LED PRO de alumbrado público y vial, de encendido instantáneo y gran potencia. Perfecto para sustituir las antiguas farolas de descarga, mejorando la calidad de la luz y reduciendo notablemente su consumo energético. Tiene una bisagra interior que mejora su estética y una óptica multiled protegida con cristal templado.

ECA LED PRO luminaire for public lighting and road, instant on and great power. Perfect to replace old discharge lamps, improving the quality of light and significantly reducing energy consumption. It has an interior hinge that improves its aesthetic and a multiLED optic protected with tempered glass.

Luminária ECA LED PRO para iluminação pública, ignição instantânea e grande potência. Ideal para substituição de lâmpadas de descarga antigas, melhorando a qualidade da luz e reduzindo significativamente o consumo energético tem uma dobradiça interior que dá-lhe mais estética e uma ótica multiled protegida com vidro temperado.



Producto desmontado necesita ensamblaje  
Disassembled product needs assembly  
Produto desmontado necessita de montagem

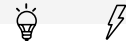

SKU		€*	mm	kg	Power	C.Temp	Lumens	Input
			A	B	C			
F3345	Módulo LED PRO 50W Module LED PRO 50W Módulo LED PRO 50W	x1 132,12€	210	210	59,30	1,5		
		356,04€				50W	4.000K	6.500
F5144	Luminaria Eca Luminaire Eca Luminária Eca	x1 223,92€	681	Ø485	Ø60	3,4		100-240V, 50/60Hz

### Accesorios | Accessories | Acessórios

\*Ecorae incluida | included | incluída

\* IVA no incluido | VAT not included | IVA não incluído



FT-3000/F3015

28,09 €\*  
-----

Protector sobre tensión Philips SP1  
Philips voltage protector SP1  
Protetor contra sobretensões Philips SP1



FT-6000/F6032

61,88 €\*  
-----

Convertor DALI - 1/10V  
DALI converter - 1/10V  
Convertor DALI - 1/10V



FT-2000/F2051

4,72 €\*  
-----

Conector  
Connector  
Ligador

IP68



FT-2000/F2052

13,15 €\*  
-----

Caja conexión 3 salidas  
Connection box 3 outputs  
Caixa de ligações 3 saídas

090-093

094-099

100-108

109-121

122-140

Luminaria solar  
Solar luminaire  
Luminária solar

Paneles  
Panels  
Painéis

Tubos  
Tubes  
Tubos

Tiras  
Strips  
Fitas

Bombillas  
Bulbs  
Lâmpadas

## STREETLIGHT HEAD INVERTED ECA

Cuerpo para luminaria INVERTED ECA LED PRO de alumbrado público y vial, de encendido instantáneo y gran potencia. Perfecto para sustituir las antiguas farolas de descarga, mejorando la calidad de la luz y reduciendo notablemente su consumo energético. Tiene una bisagra interior que mejora su estética y una óptica multiled protegida con cristal templado.

INVERTED ECA LED PRO luminaire for public lighting and road, instant on and great power. Perfect to replace old discharge lamps, improving the quality of light and significantly reducing energy consumption. It has an interior hinge that improves its aesthetic and a multiLED optic protected with tempered glass.

Luminária INVERTED ECA LED PRO para iluminação pública, ignição instantânea e grande potência. Ideal para substituição de lâmpadas de descarga antigas, melhorando a qualidade da luz e reduzindo significativamente o consumo energético tem uma dobradiça interior que dá-lhe mais estética e uma ótica multiled protegida com vidro temperado.

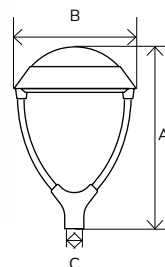

Producto desmontado necesita ensamblaje  
Disassembled product needs assembly  
Produto desmontado necessita de montagem



SKU		€*	mm	kg	Power	C.Temp	Lumens	Input
			A B C					
F3345	Módulo LED PRO 50W Module LED PRO 50W Módulo LED PRO 50W	x1 132,12€	210 210 59,30	1,5	50W	4.000K	6.500	100-240V, 50/60Hz
F5244	Luminaria Inverted Eca Luminaire Inverted Eca Luminária inverted Eca	x1 348,18€	681 Ø485 Ø60	4,3				
		480,30€						

### Accesorios | Accessories | Acessórios

\*Ecorae incluida | included | incluída  
\* IVA no incluído | VAT not included | IVA não incluído



FT-3000/F3015

28,09 €\*

Protector sobre tensión Philips SP1  
Philips voltage protector SP1  
Protetor contra sobretensões Philips SP1



FT-6000/F6032

61,88 €\*

Convertor DALI - 1/10V  
DALI converter - 1/10V  
Convertor DALI - 1/10V



FT-2000/F2051

4,72 €\*

Conector  
Connector  
Ligador

IP68



FT-2000/F2052

13,15 €\*

Caja conexión 3 salidas  
Connection box 3 outputs  
Caixa de ligações 3 saídas

020-031

Campanas  
High bays  
Campânulas

032-046

Farolas  
Streetlights  
Viárias

047-055

Proyectores  
Floodlights  
Pojetores

056-075

Downlights  
Downlights  
Downlights

076-084

Sensores  
Sensors  
Sensores

085-089

Lum. emergencia  
Emergency lum.  
Lum. emergência

## BERTA LED PRO STREETLIGHT. Osram chips

Luminaria BERTA de alumbrado público y vial, de encendido instantáneo y gran potencia con chips Osram. Perfecto para sustituir las antiguas farolas de descarga, mejorando la calidad de la luz y reduciendo notablemente su consumo energético.

BERTA luminaire for public lighting and road, instant on and great power with Osram chips. Perfect to replace old discharge lamps, improving the quality of light and significantly reducing energy consumption.

A Luminária BERTA destina-se a iluminação pública, é de acendimento instantâneo e de alta potência, equipada com chip Osram. Ideal na substituição dos antigos projectores equipados com lâmpadas de descarga, melhorando a qualidade de luz e reduzindo de uma forma significativa o consumo de energia.

5  
YEAR  
WARRANTY  
50.000HCRI  
70  
90°x150°PF  
0,95  
MOSO  
IP66  
10KV  
IK10  
130LM/W  
OSRAM  
1 PCS  
1-10 V

Model	SKU	mm			kg	Power	C.Temp	Lumens	Input	€*
		A	B	C						
FT-5250	F5245	487	Ø430	Ø76/Ø60	4,3	50W	4.000K	6.500	100-240V, 50/60Hz	535,81 €

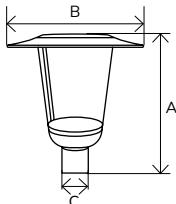
\*Ecorae incluida | included | incluída  
\* IVA no incluido | VAT not included | IVA não incluído



090-093

Luminaria solar  
Solar luminaire  
Luminária solar

094-099

Paneles  
Panels  
Painéis

100-108

Tubos  
Tubes  
Tubos

109-121

Tiras  
Strips  
Fitas

122-140

Bombillas  
Bulbs  
Lâmpadas

## Fotometría | Photometry | Fotometria

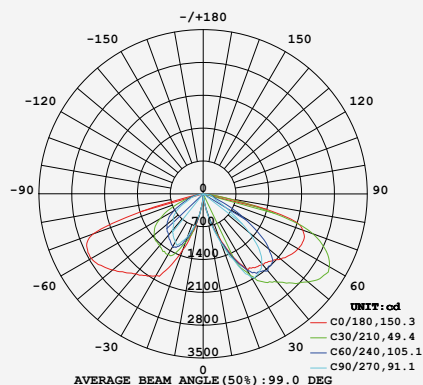

## Accesorios | Accessories | Acessórios

\*Ecorae incluida | included | incluída

\*IVA no incluido | VAT not included | IVA não incluído



FT-3000/F3015

28,09 €\*  

---

Protector sobre tensión Philips SP1  
Philips voltage protector SP1  
Protetor contra sobretensões Philips SP1

FT-6000/F6032

61,88 €\*  

---

Convertor DALI - 1/10V  
DALI converter - 1/10V  
Convertor DALI - 1/10V

FT-2000/F2051

4,72 €\*  

---

Conector  
Connector  
Ligador

IP68



FT-2000/F2052

13,15 €\*  

---

Caja conexión 3 salidas  
Connection box 3 outputs  
Caixa de ligações 3 saídas

020-031

Campanas  
High bays  
Campânulas

032-046

Farolas  
Streetlights  
Viárias

047-055

Proyectores  
Floodlights  
Pojetores

056-075

Downlights  
Downlights  
Downlights

076-084

Sensores  
Sensors  
Sensores

085-089

Lum. emergencia  
Emergency lum.  
Lum. emergência

## VILLA STREETLIGHT HEAD

La Luminaria Villa LED está fabricada en acero y presenta un diseño clásico y elegante, con un acabado en color negro. Es resistente a los rayos ultravioleta UV. Su fijación va directa a la columna o a un brazo mural con terminación en racor de 3/4".

The Villa LED luminaire is made of steel and features a classic and elegant design with a black finish. Resistant to ultraviolet UV rays. The fitting goes directly to the column or to a wall arm with a 3/4" fitting.

A luminária LED Villa é feita de aço e tem um design clássico e elegante, com um acabamento preto. É resistente aos raios ultravioleta UV. Sua fixação vai diretamente para a coluna ou para um braço de parede com um acabamento de 3/4".



No incluye módulo LED, chapa de adaptación ni protector de sobretensión SP1.

LED module adapter and voltage protector sp1 are not included.

Não inclui módulo LED, placa adaptadora ou protetor contra sobretensões SP1.

Model	SKU	mm			kg	Material	€*
		A	B	C			
FT-3000	F3012	780	395	60	6	Acero   Steel   Aço	213,84 €

\*Ecorae incluida | included | incluída

\* IVA no incluido | VAT not included | IVA não incluido

### Accesorios | Accessories | Acessórios

\*Ecorae incluida | included | incluída

\* IVA no incluido | VAT not included | IVA não incluido



FT-3350/F3344

132,12 €\*  
Módulo LED PRO.  
LED PRO module  
Módulo LED PRO3.000K  
50W, 125 L/W

FT-3350/F3345

132,12 €\*  
Módulo LED PRO.  
LED PRO module  
Módulo LED PRO4.000K  
50W, 125 L/W

FT-3350/F3305

75,37 €\*  
Módulo LED.  
LED module  
Módulo LEDECO  
4.000K  
50W

FT-3000/F3013

22,68 €\*  
Adaptador módulo LED  
LED module adapter  
Adaptador de módulo de LED

FT-3000/F3015

28,09 €\*  
Protector sobre tensión Philips SP1  
Philips voltage protector SP1  
Protetor contra sobretensões Philips SP1

FT-3000/F3014

129,60 €\*  
Brazo pared farola Villa  
Villa streetlight wall arm  
Braço poste de luz Villa

600mm



FT-6000/F6032

61,88 €\*  
Convertor DALI - 1/10V  
DALI converter - 1/10V  
Convertor DALI - 1/10V

FT-2000/F2051

4,72 €\*  
Conector  
Connector  
Ligador

IP68



FT-2000/F2052

13,15 €\*  
Caja conexión 3 salidas  
Connection box 3 outputs  
Caixa de ligações 3 saídas

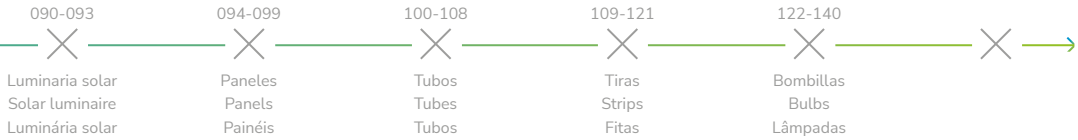

# LED STREETLIGHT BULB

Bombilla de radiación IR no UV. Encendido instantáneo del 100%. Baja salida térmica. Perfecta para sustituir lámparas incandescentes convencionales en áreas comerciales, zonas urbanas y con una larga vida útil. Solo apto para funcionamiento vertical.

Non-UV IR radiation bulb. Instant ignition of 100%. Low thermal output. Perfect to replace conventional incandescent lamps in commercial areas, urban areas and with a long service life. Suitable for vertical operation only.

Lâmpada sem radiação ir e UV. Ignição instantânea 100%. Baixa emissão térmica. Ideal para substituir lâmpadas incandescentes convencionais em locais comerciais, espaços urbanos e com uma longa vida útil.

Solo apto para funcionamiento vertical.  
Suitable for vertical operation only.  
Apenas para utilização vertical

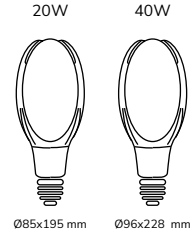

- 2 YEAR WARRANTY**
- 25.000H**
- CRI >80**
- 330°**
- IP20**
- SP 1KV**
- E27**
- PF >0,9**
- SMD**
- 20 PCS**

Model	Sku	Power	C.Temp	LM/W	Lumens	Input	€*
-------	-----	-------	--------	------	--------	-------	----

\*Ecorae incluida | included | incluída  
\* IVA no incluido | VAT not included | IVA não incluído

FT-3420	F3411	20W	3.000K	130	2.600	220-240V, 50Hz	29,48 €
	F3412		4.000K				
	F3413		6.500K				
FT-3440	F3414	40W	3.000K	5.200	220-240V, 50Hz	36,73 €	
	F3415		4.000K				
	F3416		6.500K				

## Fotometría | Photometry | Fotometria

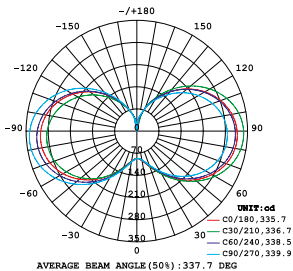

**330°**  
Ángulo apertura  
Beam angle  
Ângulo de abertura

## Accesorios | Accessories | Acessórios

\*Ecorae incluida | included | incluída  
\* IVA no incluido | VAT not included | IVA não incluído



**FT-3445/F3404 8,31 €\***

Adaptador conversor E40-E27  
E40-E20 converter adapter  
Adaptador conversor E40-E20

020-031

Campanas  
High bays  
Campânulas

032-046

Farolas  
Streetlights  
Viárias

047-055

Proyectores  
Floodlights  
Pojetores

056-075

Downlights  
Downlights  
Downlights

076-084

Sensores  
Sensors  
Sensores

085-089

Lum. emergencia  
Emergency lum.  
Lum. emergência

## LED MODULE 130 L/W. Bridgelux LED

El módulo LED de Filux está fabricado según los estándares de calidad más exigentes y ofrece una garantía de 5 años. Presenta una gran resistencia a las condiciones meteorológicas extremas.

Filux's LED module is manufactured to the highest quality standards and offers a 5-year warranty. It is highly resistant to extreme weather conditions.

O módulo LED Filux é fabricado de acordo com os mais elevados padrões de qualidade oferecendo uma garantia de 5 anos. É bastante resistente a condições climáticas adversas.

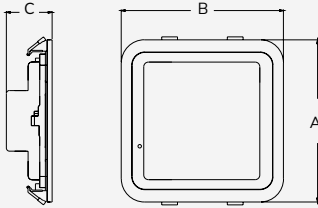
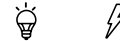
**5**  
YEAR  
WARRANTY  
50.000HCRI  
>80  
TYPE IIPF  
>0,9  
STEP DIMMING  
REGULATION  
IP66  
4KV  
IK08  
130LM/W  
10 PCS

Model	SKU	mm			kg	Power	C.Temp	Lumens	Input	€*
		A	B	C						
FT-3350	F3344	210	59,30	1,5	50W	3.000K	6.500	100-240V, 50/60Hz	132,12 €	
	F3345					4.000K				

\*Ecorae incluida | included | incluida  
\* IVA no incluido | VAT not included | IVA não incluído

### Fotometría | Photometry | Fotometria

TYPE II | Ángulo apertura  
Beam angle  
Ângulo de abertura

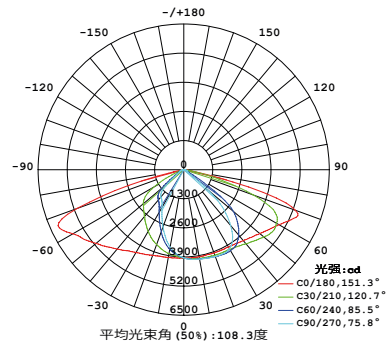

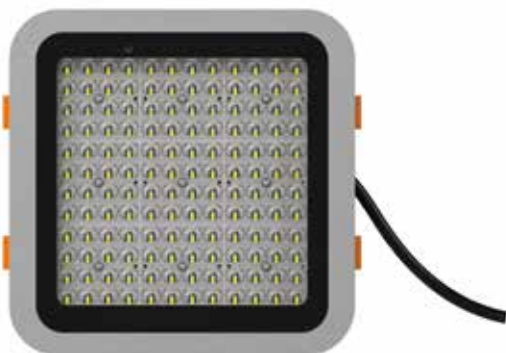

## Accesorios | Accessories | Acessórios

\*Ecorae incluida | included | incluída  
\* IVA no incluido | VAT not included | IVA não incluído



**FT-3000/F3015** **28,09 €\***

Protector sobre tensión Philips SP1  
Philips voltage protector SP1  
Protetor contra sobretensões Philips SP1



**FT-6000/F6032** **61,88 €\***

Conversor DALI - 1/10V  
DALI converter - 1/10V  
Conversor DALI - 1/10V



**FT-2000/F2051** **4,72 €\***

Conector  
Connector  
Ligador

IP68



**FT-2000/F2052** **13,15 €\***

Caja conexión 3 salidas  
Connection box 3 outputs  
Caixa de ligações 3 saídas

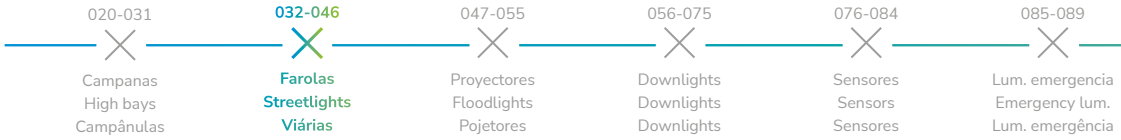

# LED MODULE 110 L/W

Los módulos LED Filux están fabricados según los estándares de calidad más exigentes y ofrecen una garantía de 3 años. Presentan una gran resistencia a las condiciones meteorológicas extremas.

Filux LED modules are manufactured to the highest quality standards and offer a 3 year warranty. They are highly resistant to extreme weather conditions.

Os módulos LED Filux são fabricados com os elevados padrões de qualidade oferecendo uma garantia de 3 anos. Têm grande resistência às condições climáticas extremas.

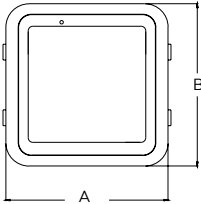

**3**  
YEAR  
WARRANTY

**50.000H**

**CRI**  
>80

**TYPE II**

**PF**  
>0,9



IP65



4KV



IK08



110LM/W



10 PCS



SMD



Model	Sku	mm			kg	Power	C.Temp	Lumens	Input	€*
		A	B	C						
FT-3350	F3305	210	59,30	1,5	50W	4.000K	5.500	100-240V, 50/60Hz	75,37 €	

\*Ecorae incluída | included | incluída

\* IVA no incluído | VAT not included | IVA não incluído

## Fotometría | Photometry | Fotometria

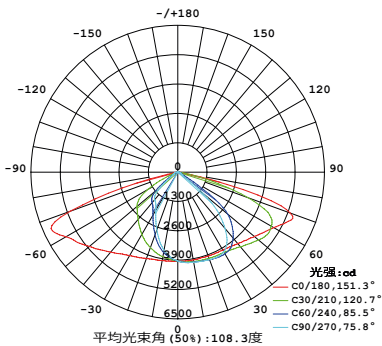

TYPE II

Ángulo apertura  
Beam angle  
Ângulo de abertura

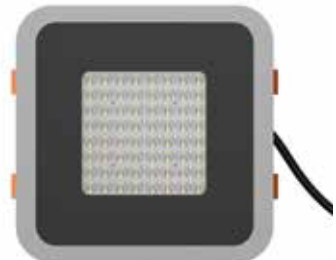



047-055



Proyectores

Floodlights

Projetores



020-031

Campanas  
High bays  
Campânulas

032-046

Farolas  
Streetlights  
Viárias

047-055

Proyectores  
Floodlights  
Pojetores

056-075

Downlights  
Downlights  
Downlights

076-084

Sensores  
Sensors  
Sensores

085-089

Lum. emergencia  
Emergency lum.  
Lum. emergência

## LED PRO SPORT

Es el sustituto perfecto para la sustitución de los focos en campos de fútbol, aeropuertos y puertos. Se puede inclinar para dirigir la luz en función de las necesidades del momento. El ángulo de apertura resulta muy adecuado como elemento de iluminación general.

It's the perfect substitute for the replacement of the floodlights in soccer stadiums, airports and ports. It can be tilted to direct the light according to the needs of the moment. The opening angle is very suitable as a general lighting element.

É a solução perfeita para utilização em campos de futebol, aeroportos e portos. Permite a orientação do feixe de luz. O ângulo de abertura é um elemento na iluminação geral.

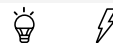
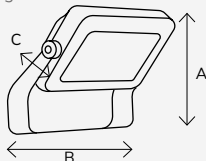

SKU		€*	mm			kg	Power	C.Temp	Lumens	Input
			A	B	C					
F8510	Módulo 240W proyector deportivo Module 240W sport floodlight Módulo projetor desportivo 240W	x1 470,87 €								
F8511	Kit soporte proyector deportivo 240W Support kit sport floodlight 240W Kit suporte projetor desportivo 240W	x1 167,48 €	230	420	110	5	240W		33.600	
F8510	Módulo 240W proyector deportivo Module 240W sport floodlight Módulo projetor desportivo 240W	x2 470,87 €								
F8512	Kit soporte proyector deportivo 480W Support kit sport floodlight 480W Kit suporte projetor desportivo 480W	x1 357,58 €	470			11	480W	5.000K	67.200	100-240V, 50/60Hz
F8510	Módulo 240W proyector deportivo Module 240W sport floodlight Módulo projetor desportivo 240W	x3 470,87 €								
F8513	Kit soporte proyector deportivo 720W Support kit sport floodlight 720W Kit suporte projetor desportivo 720W	x1 454,64 €	720	440	110	16	720W		100.800	
F8510	Módulo 240W proyector deportivo Module 240W sport floodlight Módulo projetor desportivo 240W	x4 470,87 €								
F8514	Kit soporte proyector deportivo 960W Support kit sport floodlight 960W Kit suporte projetor desportivo 960W	x1 544,08 €	940			22	960W		134.400	

\*Ecorae incluida | included | incluída

\* IVA no incluído | VAT not included | IVA não incluído



090-093

Luminaria solar  
Solar luminaire  
Luminária solar

094-099

Paneles  
Panels  
Painéis

100-108

Tubos  
Tubes  
Tubos

109-121

Tiras  
Strips  
Fitas

122-140

Bombillas  
Bulbs  
Lâmpadas

**5**  
YEAR  
WARRANTY

  
**50.000H**

**CRI**  
**>80**

  
**45°**

**PF**  
**>0,93**

  
**SMD**

  
**IP66**

  
**10KV**

  
**IK10**

  
**140LM/W**

  
**MEANWELL**

  
**LUMILEDS**



### Fotometrías | Photometries | Fotometrias

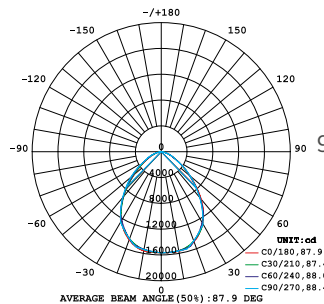
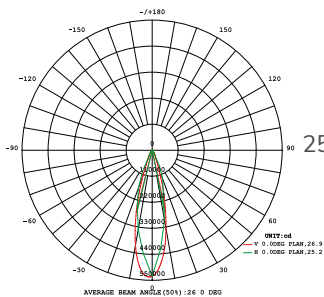
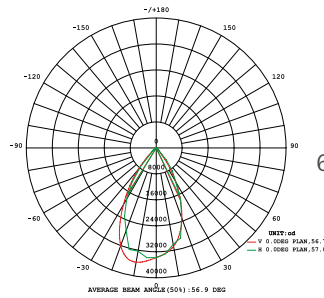
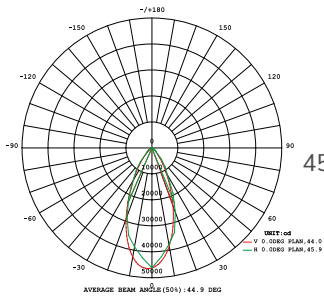

020-031

Campanas  
High bays  
Campânulas

032-046

Farolas  
Streetlights  
Viárias

047-055

Proyectores  
Floodlights  
Pojetores

056-075

Downlights  
Downlights  
Downlights

076-084

Sensores  
Sensors  
Sensores

085-089

Lum. emergencia  
Emergency lum.  
Lum. emergência

## LED PRO SPORT

### Accesorios | Accessories | Acessórios

\*Ecorae incluida | included | incluída

\*IVA no incluido | VAT not included | IVA não incluído



FT-8500/F8515

32,13 €\*

---

Lente 25° para módulo 240W  
25° lens for module 240W  
Lente de 25° para módulo 240W

FT-8500/F8516

32,13 €\*

---

Lente 60° para módulo 240W  
60° lens for module 240W  
Lente de 60° para módulo 240W

FT-8500/F8517

32,13 €\*

---

Lente 90° para módulo 240W  
90° lens for module 240W  
Lente de 90° para módulo 240W

FT-8500/F8518

31,66 €

---

Visera modular para módulo 240W  
Metallic reflector for module 240W  
Viseira modular para módulo 240W

FT-2000/F2051

4,72 €\*

---

Conector  
Connector  
Ligador

IP68



FT-2000/F2052

13,15 €\*

---

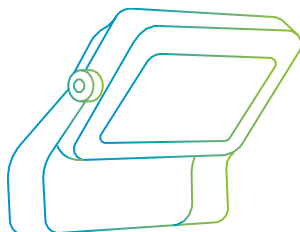
Caja conexión 3 salidas  
Connection box 3 outputs  
Caixa de ligações 3 saídas

090-093



Luminaria solar  
Solar luminaire  
Luminária solar

094-099



Paneles  
Panels  
Painéis

100-108



Tubos  
Tubes  
Tubos

109-121



Tiras  
Strips  
Fitas

122-140



Bombillas  
Bulbs  
Lâmpadas





## LED FLOODLIGHTS

Es el sustituto perfecto para los focos halógenos de exterior. Se puede inclinar para dirigir la luz en función de las necesidades del momento. La luz que emite es de alta calidad como indica su CRI. El ángulo de apertura resulta muy adecuado como elemento de iluminación general.

The perfect substitute for outdoor halogen spotlights. It can be tilted to direct the light according to the needs of the moment. The light it emits is of high quality as its CRI indicates. The opening angle is very suitable as a general lighting element.

É o substituto perfeito para holofotes de halogênio ao ar livre. Pode ser inclinado para direcionar a luz, dependendo da necessidades do momento. A luz que emite é alta qualidade como indicado pelo seu CRI. Os resultados do ângulo de abertura muito adequado como elemento de iluminação geral.

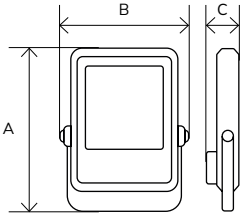

**5**  
YEAR  
WARRANTY

**50.000H**

**CRI**  
>80

**110°**

**IP65**

**PF**  
0,95

**IK07**

**SMD**

**1m.**  
CABLE



Model	SKU	mm	kg	Power	C.Temp	Lumens	LM/W	Input	SP	Units p/pack	€*
-------	-----	----	----	-------	--------	--------	------	-------	----	--------------	----

A B C

\*Ecoraee incluida | included | inclusa  
\* IVA no incluido | VAT not included | IVA não incluído

FT-21015	F2125	176	136	36	0,6	15W	3.000K	1.950	130	110-240V, 50/60Hz	2KV	12	24,92 €
	F2126						4.000K						
	F2127						5.700K						
FT-21030	F2128	176	136	36	0,6	30W	3.000K	3.900	130	110-240V, 50/60Hz	2KV	12	28,89 €
	F2129						4.000K						
	F2130						5.700K						



090-093

Luminaria solar  
Solar luminaire  
Luminária solar

094-099

Paneles  
Panels  
Painéis

100-108

Tubos  
Tubes  
Tubos

109-121

Tiras  
Strips  
Fitas

122-140

Bombillas  
Bulbs  
Lâmpadas

Model	SKU	mm		kg	Power	C.Temp	Lumens	LM/W	Input	SP	Units p/pack	€*
-------	-----	----	--	----	-------	--------	--------	------	-------	----	--------------	----

A B C

\*\*Ecoraee incluida | included | incluída  
\* IVA no incluido | VAT not included | IVA não incluído

Model	SKU	A	B	C	kg	Power	C.Temp	Lumens	LM/W	Input	SP	Units p/pack	€*
FT-21050	F2131	221,5	149	40	0,9	50W		3.000K	6.500			12	43,01 €
	F2132							4.000K					
	F2133							5.700K					
FT-21100	F2134	264,5	208		1,5	100W		3.000K	13.000			10	69,62 €
	F2135							4.000K					
	F2136							5.700K					
FT-21150	F2137	330	260	44	2,8	150W		3.000K	19.500	130	110-240V, 50/60Hz	4KV	134,64 €
	F2138							4.000K					134,64 €
	F2139							5.700K					
FT-21200	F2140	365	285	48	3,2	200W		3.000K	26.000			4	171,29 €
	F2143							4.000K					
	F2144							5.700K					
FT-21250	F2145	425	315	50	4,1	250W		3.000K	32.500			4	227,99 €
	F2146							4.000K					
	F2147							5.700K					

020-031



Campanas  
High bays  
Campânulas

032-046



Farolas  
Streetlights  
Viárias

047-055



Proyectores  
Floodlights  
Pojetores

056-075



Downlights  
Downlights  
Downlights

076-084



Sensores  
Sensors  
Sensores

085-089



Lum. emergencia  
Emergency lum.  
Lum. emergência

# LED FLOODLIGHTS

Fotometrías | Photometries | Fotometrias

50W

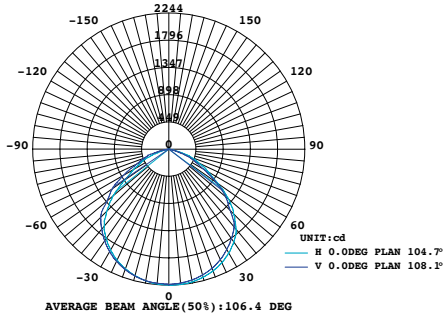

100W

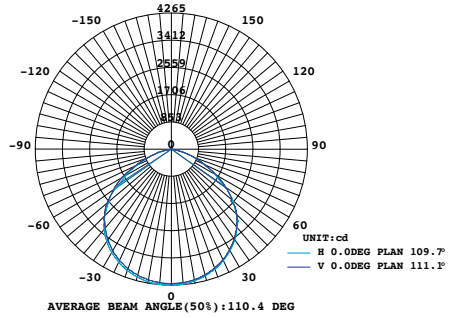

150W

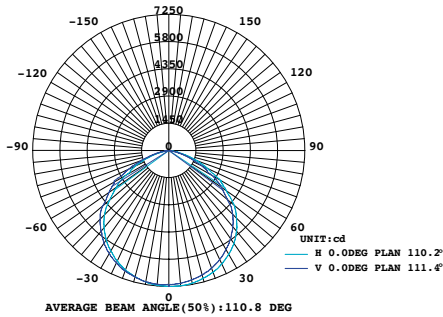

200W

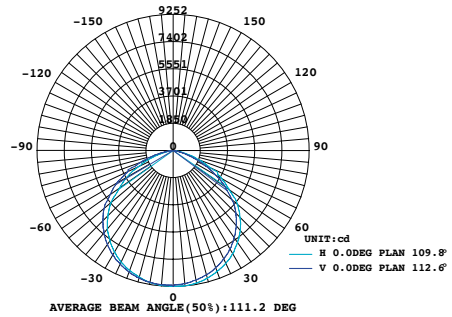

250W

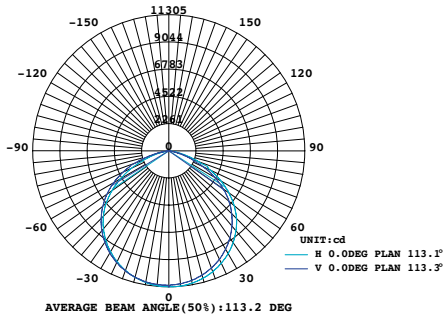

110°

Ángulo apertura  
Beam angle  
Ângulo de abertura

090-093

Luminaria solar  
Solar luminaire  
Luminária solar

094-099

Paneles  
Panels  
Painéis

100-108

Tubos  
Tubes  
Tubos

109-121

Tiras  
Strips  
Fitas

122-140

Bombillas  
Bulbs  
Lâmpadas

Accesorios | Accessories | Acessórios

\*Ecorae incluida | included | incluída

\* IVA no incluido | VAT not included | IVA não incluído



FT-2000/F2000

46,20 €\*  

---

Trípode para dos proyectores  
Tripod for two projectors  
Tripé para dois projetores

FT-2000/F2051

4,72 €\*  

---

Conector  
Connector  
Ligador

IP68



FT-2000/F2052

13,15 €\*  

---

Caja conexión 3 salidas  
Connection box 3 outputs  
Caixa de ligações 3 saídas

## LED FLOODLIGHT W/MOTION SENSOR

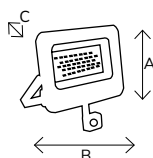

Model	SKU	mm			Power	C.Temp	Lumens	Input	IK	SP	Units p/pack	€*
		A	B	C								
FT-21050	F2124	264	240	50	50W	4.500K	5.000	180-265V, 50Hz	06	1,5	10	50,32 €

\*Ecorae incluida | included | incluída

\* IVA no incluido | VAT not included | IVA não incluído



056-075



Downlights

Downlights

Downlights





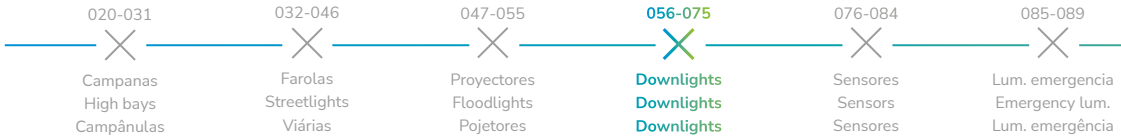

# ROUND LED DOWNLIGHT

Ideales para la iluminación ambiental, reemplazo ideal de luminarias fluorescentes. El producto perfecto para la iluminación de todo tipo de interiores donde se busque dirigir la luz hacia algún punto en concreto, tanto en viviendas particulares, como para usos profesionales en comercios, restaurantes y tiendas, entre otros. Este downlight cuenta con la posibilidad de elegir la temperatura de color.

Ideal for ambient lighting, ideal replacement for fluorescent luminaires. The perfect product for the illumination of all types of interiors where it is sought to direct the light to some specific point, in private houses, for professional uses in shops, restaurants and shops, among others. This downlight offers the possibility to change the color temperature.

Ideais para iluminação ambiente. Ideal para a substituição de downlights fluorescentes. Produto perfeito para iluminação de todos os tipos de interiores onde se pretende direcionar a luz para algum ponto em concreto, tanto em uso residencial, om em uso profissional, tais como, em lojas, restaurantes, entre outros este downlight tem a possibilidade de escolher a temperatura de cor.



**5**  
YEAR WARRANTY

**30.000H**

**CRI >80**

**100°**

**PF >0,9**

**TRIAC DIMMABLE**

**IP44 Front**

**IP20 Back**

**ANTI-GLARE**

**K ALL IN ONE**

**SMD**

**+40° | -20°**

Model	SKU	mm		g	Power	Lumens	Input	Units p/pack	€*
-------	-----	----	--	---	-------	--------	-------	--------------	----

		A	B	Cut	*Ecoraee incluída   included   incluída * IVA no incluído   VAT not included   IVA não incluído					
FT-9005	F9075	Ø 96	52,5	Ø 75	104,4	6W	550-620	220-240V, 50/60Hz	12	17,50 €
	F9078	Ø 150	62,5	Ø 125	246,5	11W	1.150-1300			32,63 €
	F9081	Ø 228	85	Ø 200	340	20W	2.150-2.400	8	59,32 €	

Fotometría | Photometrie | Fotometria

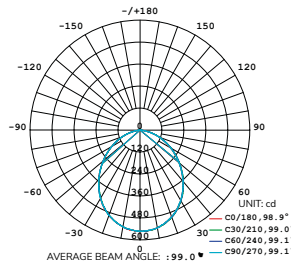

100°

Ángulo apertura  
Beam angle  
Ângulo de abertura

090-093



Luminaria solar  
Solar luminaire  
Luminária solar

094-099



Paneles  
Panels  
Painéis

100-108



Tubos  
Tubes  
Tubos

109-121



Tiras  
Strips  
Fitas

122-140



Bombillas  
Bulbs  
Lâmpadas

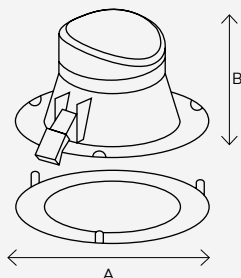

## ROUND LED DOWNLIGHT ACCESSORIES

Model	SKU	Descripción   Description   Descrição	€*
FT-9005	F9076	Aro negro para F9075 Black hoop for F9075 Aro preto para F9075	5,03 €
	F9077	Aro cromo satinado para F9075 Chrome satin ring for F9075 Anel de cetim cromado para F9075	4,24 €
	F9079	Aro negro para F9078 Black hoop for F9078 Aro preto para F9078	6,84 €
	F9080	Aro cromo satinado para F9078 Chrome satin ring for F9078 Anel de cetim cromado para F9078	5,87 €
	F9082	Aro negro para F9081 Black hoop for F9081 Aro preto para F9081	8,82 €
	F9083	Aro cromo satinado para F9081 Chrome satin ring for F9081 Anel de cetim cromado para F9081	8,04 €
FT-2000	F2053	Conector IP20 IP20 connector Conector IP20	1,14 €

\*Ecoraee incluida | included | incluída \* IVA no incluido | VAT not included | IVA não incluído





## ROUND LED DOWNLIGHT

Ideales para la iluminación ambiental, reemplazo ideal de luminarias fluorescentes. El producto perfecto para la iluminación de todo tipo de interiores donde se busque dirigir la luz hacia algún punto en concreto, tanto en viviendas particulares, como para usos profesionales en comercios, restaurantes y tiendas, entre otros. Este downlight cuenta con la posibilidad de elegir la temperatura de color.

Ideal for ambient lighting, ideal replacement for fluorescent luminaires. The perfect product for the illumination of all types of interiors where it is sought to direct the light to some specific point, in private houses, for professional uses in shops, restaurants and shops, among others. This downlight offers the possibility to change the color temperature.

Ideais para iluminação ambiente. Ideal para a substituição de downlights fluorescentes. Produto perfeito para iluminação de todos os tipos de interiores onde se pretende direccionar a luz para algum ponto em concreto, tanto em uso residencial ou em uso profissional, tais como, em lojas, restaurantes, entre outros este downlight tem a possibilidade de escolher a temperatura de cor.



**3**  
YEAR  
WARRANTY

**30.000H**

**CRI**  
>80

**100°**

**IP44 Front**

**IP20 Back**

**1KV**

**K 3000  
4000  
6000  
ALL IN ONE**

**SMD**



Model	SKU	mm		kg	Power	Lumens	Input	Units p/pack	€*	
		A	B	Cut						
FT-9008	F9068	Ø 115	32	Ø 105	0,11	6W	200-240V, 50/60Hz	50	13,08 €	
FT-9015	F9069	Ø 170		Ø 155	0,20	12W		1.100-1.200	40	18,40 €
FT-9020	F9070	Ø 220		Ø 205	0,33	18W		1.700-1.800	20	25,35 €
FT-9025	F9071	Ø 240		Ø 225	0,37	24W		2.200-2.400		30,22 €

\*Ecorae incluida | included | incluída  
\* IVA no incluido | VAT not included | IVA não incluído

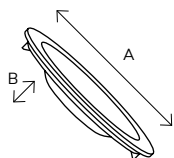

090-093

Luminaria solar  
Solar luminaire  
Luminária solar

094-099

Paneles  
Panels  
Painéis

100-108

Tubos  
Tubes  
Tubos

109-121

Tiras  
Strips  
Fitas

122-140

Bombillas  
Bulbs  
Lâmpadas3.000K  
4.000K  
6.000K

Fotometría | Photometrie | Fotometria

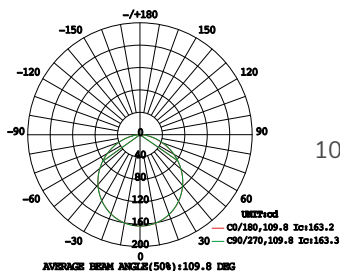

## SURFACE MOUNTING KIT



Model	SKU	Descripción   Description   Descrição	€*
FT-9001	F9061	Kit superficie redondo para F9068 Round surface kit for F9068 Kit de superficie redondo para F9068	5,06 €
	F9062	Kit superficie redondo para F9069 Round surface kit for F9069 Kit de superficie redondo para F9069	7,59 €
	F9063	Kit superficie redondo para F9070 Round surface kit for F9070 Kit de superficie redondo para F9070	9,23 €
	F9064	Kit superficie redondo para F9071 Round surface kit for F9071 Kit de superficie redondo para F9071	9,53 €
FT-2000	F2053	Conector IP20 IP20 connector Ligador IP20	1,14 €

\*Ecoraee incluída | included | incluída \* IVA no incluído | VAT not included | IVA não incluído

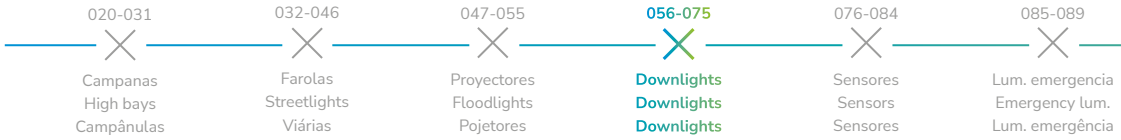

# SQUARE LED DOWNLIGHT

Ideales para la iluminación ambiental, reemplazo ideal de luminarias fluorescentes. El producto perfecto para la iluminación de todo tipo de interiores donde se busque dirigir la luz hacia algún punto en concreto, tanto en viviendas particulares, como para usos profesionales en comercios, restaurantes y tiendas, entre otros. Este downlight cuenta con la posibilidad de elegir la temperatura de color.

Ideal for ambient lighting, ideal replacement for fluorescent luminaires. The perfect product for the illumination of all types of interiors where it is sought to direct the light to some specific point, in private houses, for professional uses in shops, restaurants and shops, among others. This downlight offers the possibility to change the color temperature.

Ideais para iluminação ambiente. Ideal para a substituição de downlights fluorescentes. Produto perfeito para iluminação de todos os tipos de interiores onde se pretende direcionar a luz para algum ponto em concreto, tanto em uso residencial ou em uso profissional, tais como, em lojas, restaurantes, entre outros este downlight tem a possibilidade de escolher a temperatura de cor.



**3**  
YEAR  
WARRANTY

**30.000H**

**CRI**  
>80

**100°**

**IP44 Front**

**IP20 Back**

**1KV**

**K 3000 4000 6000**  
ALL IN ONE

**SMD**



Model	SKU	mm			kg	Power	Lumens	Input	Units p/pack	€*	
		A	B	C	Cut						
FT-9008	F9072	115	115	32	105X105	0,11	6W	500-600	220-240V, 50/60Hz	50	12,04 €
FT-9015	F9073	165	165		155X155	0,21	12W	1.100-1.200		40	17,24 €
FT-9020	F9074	220	220		205X205	0,33	18W	1.700-1.800		20	25,37 €

\*Ecoraee incluída | included | incluída  
\* IVA no incluido | VAT not included | IVA não incluído

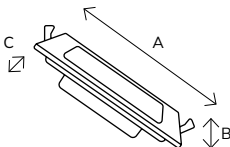

090-093

Luminaria solar  
Solar luminaire  
Luminária solar

094-099

Paneles  
Panels  
Painéis

100-108

Tubos  
Tubes  
Tubos

109-121

Tiras  
Strips  
Fitas

122-140

Bombillas  
Bulbs  
Lâmpadas

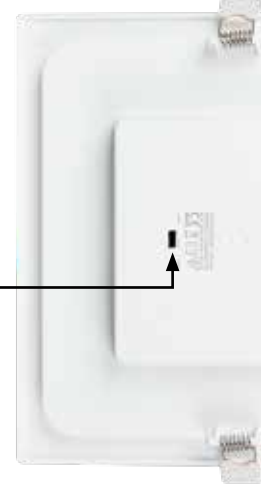

3.000K  
4.000K  
6.000K

Fotometría | Photometrie | Fotometria

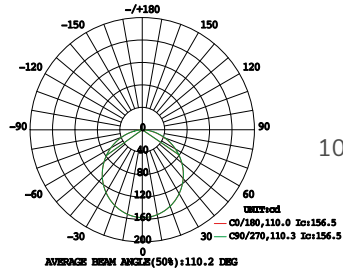

100°

Ángulo apertura  
Beam angle  
Ângulo de abertura

## SURFACE MOUNTING KIT



Model	SKU	Descripción   Description   Descrição	€*
FT-9001	F9065	Kit superficie cuadrado para F9072 Square surface kit for F9072 Kit de superficie quadrada para F9072	6,12 €
	F9066	Kit superficie cuadrado para F9073 Square surface kit for F9073 Kit de superficie quadrada para F9073	8,36 €
	F9067	Kit superficie cuadrado para F9074 Square surface kit for F9074 Kit de superficie quadrada para F9074	10,71 €
FT-2000	F2053	Conector IP20 IP20 connector Ligador IP20	1,14 €

\*Ecorae incluida | included | incluída \* IVA no incluido | VAT not included | IVA não incluído

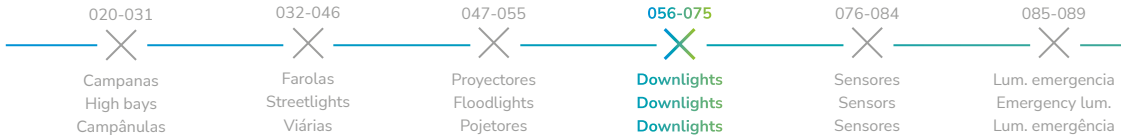

## RECESSED LED DOWNLIGHTS

Los Downlights LED de Filux son ideales para la iluminación ambiental, reemplazo ideal de luminarias fluorescentes. El producto perfecto para la iluminación de todo tipo de interiores donde se busque dirigir la luz hacia algún punto en concreto, tanto en viviendas particulares, como para usos profesionales en comercios, restaurantes y tiendas, entre otros.

Filux LED downlights are ideal for ambient lighting, ideal replacement for fluorescent luminaires. The perfect product for the illumination of all types of interiors where it is sought to direct the light to some specific point, in private houses, for professional uses in shops, restaurants and shops, among others.

Os downlights LED Filux são ideais para iluminação ambiente. Ideal para a substituição de downlights fluorescentes. Produto perfeito para iluminação de todos os tipos de interiores onde se pretende direcionar a luz para algum ponto em concreto, tanto em uso residencial ou em uso profissional, tais como, em lojas, restaurantes.



**2**  
YEAR  
WARRANTY

**25.000H**

**CRI**  
**>75**

**120°**

**IP20**

**SMD**



Model	SKU	Shape	mm	Cut	Power	C.Temp	Lumens	kg	Units p/pack	€*
*Ecoraee incluída   included   incluída * IVA no incluído   VAT not included   IVA não incluído										
FT-9006	F9001	○	Ø 120x17	Ø 105	6W	3.000K	390	0,124	100	6,80 €
	F9002					4.000K				
	F9003					6.000K				
FT-9012	F9004		Ø 170x17	Ø 155	12W	3.000K	960	0,225	40	9,11 €
	F9005					4.000K				
	F9006					6.000K				
FT-9018	F9007		Ø 225x17	Ø 205	18W	3.000K	1.530	0,359	20	11,65 €
	F9008					4.000K				
	F9009					6.000K				
FT-9024	F9010		Ø 300x17	Ø 285	24W	3.000K	2.040	0,432	20	19,15 €
	F9011					4.000K				
	F9012					6.000K				





Fotometría | Photometrie | Fotometria

120° | Ángulo apertura  
Beam angle  
Ângulo de abertura

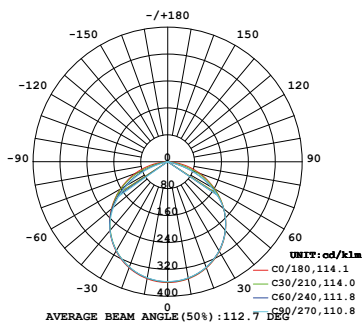

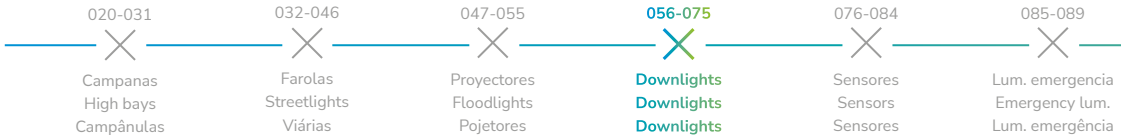

# LED DOWNLIGHT. Samsung led

El modelo F9084 cuenta con chips de Samsung y es orientable. Los Downlights LED de Filux son ideales para la iluminación ambiental, reemplazo ideal de luminarias fluorescentes. El producto perfecto para la iluminación de todo tipo de interiores donde se busque dirigir la luz hacia algún punto en concreto. Este downlight cuenta con la posibilidad de elegir la temperatura de color.

The F9084 model has Samsung chips and is adjustable. Filux LED downlights are ideal for ambient lighting, ideal replacement for fluorescent luminaires. The perfect product for the illumination of all types of interiors where it is sought to direct the light to some specific point. This downlight offers the possibility to change the color temperature.

O modelo F9084 possui chips Samsung e é dirigível. Os downlights LED Filux são ideais para iluminação ambiente. Ideal para a substituição de downlights fluorescentes. Produto perfeito para iluminação de todos os tipos de interiores onde se pretende direcionar a luz para algum ponto em concreto. Entre outros este downlight tem a possibilidade de escolher a temperatura de cor.



- 5**  
YEAR WARRANTY
- 30.000H**
- CRI 90**
- 90°**
- PF >0,9**
- W 28/38**
- 12 PCS**
- IP20**
- ADJUSTABLE**
- IK05**
- K 3000 4000 5700 ALL IN ONE**
- LIFUD**
- SAMSUNG**
- 110LM/W**
- SMD**

Model	SKU	mm		kg	Power	Lumens	Input	€*	
		A	B	Cut					
FT-9038	F9084	Ø 195	4	Ø 165	1,0	28W 38W	2.500 3.230	220- 240V 50/60Hz	122,34 €

Fotometría | Photometrie | Fotometria

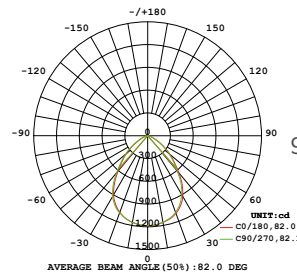

Ángulo apertura  
Beam angle  
Ângulo de abertura

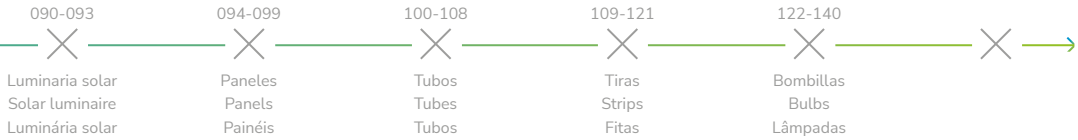

## LED DOWNLIGHT. Samsung led

El modelo F9085 cuenta con chips de Samsung y es orientable. Los Downlights LED de Filux son ideales para la iluminación ambiental, reemplazo ideal de luminarias fluorescentes. El producto perfecto para la iluminación de todo tipo de interiores donde se busque dirigir la luz hacia algún punto en concreto. Este downlight cuenta con la posibilidad de elegir la temperatura de color.

The F9085 model has Samsung chips and is adjustable. Filux LED downlights are ideal for ambient lighting, ideal replacement for fluorescent luminaires. The perfect product for the illumination of all types of interiors where it is sought to direct the light to some specific point. This downlight offers the possibility to change the color temperature.

O modelo F9085 possui chips Samsung e é dirigível. Os downlights LED Filux são ideais para iluminação ambiente. Ideal para a substituição de downlights fluorescentes. Produto perfeito para iluminação de todos os tipos de interiores onde se pretende direcionar a luz para algum ponto em concreto. Entre outros este downlight tem a possibilidade de escolher a temperatura de cor.



**5**  
YEAR  
WARRANTY

**30.000H**

**CRI**  
90

**100°**

**PF**  
>0,9

**6 PCS**

**IP20**

**ADJUSTABLE**

**IK05**

**K** 3000  
4000  
5700  
**ALL IN ONE**

**LIFUD**

**SAMSUNG**

**SMD**

Model	SKU	mm		kg	Power	Lumens	Input	€*	
		A	B	Cut	*Ecoraee incluida   included   incluída * IVA no incluido   VAT not included   IVA não incluído				
FT-9038	F9085	240	145	min 215x125 max 227x130	1,1	38W	3.570	220- 240V 50/60Hz	126,64 €

Fotometría | Photometrie | Fotometria

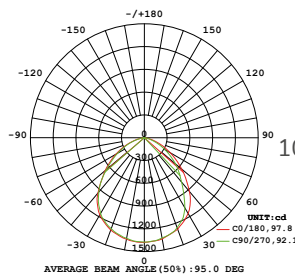

Ángulo apertura  
Beam angle  
Ângulo de abertura

020-031

Campanas  
High bays  
Campânulas

032-046

Farolas  
Streetlights  
Viárias

047-055

Proyectores  
Floodlights  
Pojetores

056-075

Downlights  
Downlights  
Downlights

076-084

Sensores  
Sensors  
Sensores

085-089

Lum. emergencia  
Emergency lum.  
Lum. emergência

## ROUND LED DOWNLIGHT

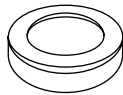
2  
YEAR  
WARRANTY

30.000H

CRI  
>80

120°

IP65

-25° | +45°

SMD

24 PCS



Model	SKU	Color	mm	kg	Power	C.Temp	Lumens	Input	€*
*Ecoraee incluída   included   incluída * IVA no incluido   VAT not included   IVA não incluído									
FT-9015	F9086	White	Ø190x45	0,30	15W		3.000K	220-240V, 50/60Hz	24,51 €
	F9087						4.000K		
	F9088	Black					3.000K		
							F9089		

Fotometría | Photometrie | Fotometria

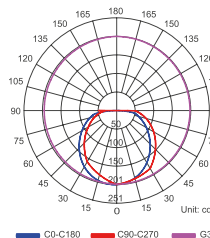

120°

Ángulo apertura  
Beam angle  
Ângulo de abertura

090-093

Luminaria solar  
Solar luminaire  
Luminária solar

094-099

Paneles  
Panels  
Painéis

100-108

Tubos  
Tubes  
Tubos

109-121

Tiras  
Strips  
Fitas

122-140

Bombillas  
Bulbs  
Lâmpadas

## SQUARE LED DOWNLIGHT

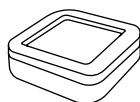
**2**  
YEAR  
WARRANTY**30,000H****CRI**  
>80**120°**

IP65



-25° | +45°



SMD



24 PCS



Model	SKU	Color	mm	kg	Power	C.Temp	Lumens	Input	€*
-------	-----	-------	----	----	-------	--------	--------	-------	----

\*Ecoraee incluída | included | incluída \* IVA no incluído | VAT not included | IVA não incluído

FT-9015	F9090	White	190x190x45	0,37	15W	3.000K	1.000	220-240V, 50/60Hz	25,11 €
	F9091					4.000K			
	F9092	Black				3.000K			
						F9093			

Fotometría | Photometrie | Fotometria

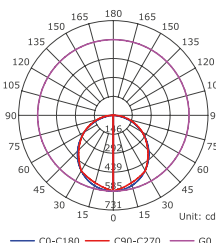

120°

Ángulo apertura  
Beam angle  
Ângulo de abertura

020-031

Campanas  
High bays  
Campânulas

032-046

Farolas  
Streetlights  
Viárias

047-055

Proyectores  
Floodlights  
Pojetores

056-075

Downlights  
Downlights  
Downlights

076-084

Sensores  
Sensors  
Sensores

085-089

Lum. emergencia  
Emergency lum.  
Lum. emergência

## SURFACE LED WALL LIGHT

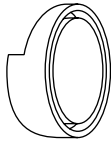

**2**  
YEAR  
WARRANTY

30.000H

CRI  
>80

120°

IP54

-25° | +45°

SMD

20 PCS



Model	SKU	Color	mm	kg	Power	C.Temp	Lumens	Input	€*
*Ecoraee incluída   included   incluída * IVA no incluído   VAT not included   IVA não incluído									
FT-9015	F9094	Black	Ø220x68	0,40	18W	3.000K	1.260	220-240V, 50/60Hz	29,47 €
	F9095					4.000K			

Fotometría | Photometrie | Fotometria

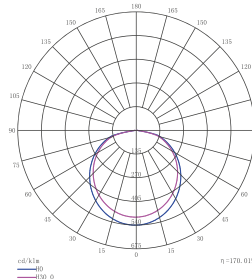

120°

Ângulo abertura  
Beam angle  
Ângulo de abertura

090-093

Luminaria solar  
Solar luminaire  
Luminária solar

094-099

Paneles  
Panels  
Painéis

100-108

Tubos  
Tubes  
Tubos

109-121

Tiras  
Strips  
Fitas

122-140

Bombillas  
Bulbs  
Lâmpadas

## LED CEILING LIGHT

**2**  
YEAR  
WARRANTY  
30.000H**CRI**  
>80  
120°  
8 PCS  
IP54  
IK07  
-25° | +45°**PF**  
>0,9  
SMD

Model	SKU	Color	mm	kg	Power	C.Temp	Lumens	Input	€*
*Ecoraee incluída   included   incluída * IVA no incluido   VAT not included   IVA não incluído									
FT-9015	F9098	Grey	Ø350x60	0,92	28W	3.000K	2.400	170-265V, 50/60Hz	68,00 €
	F9099					4.000K			

Fotometría | Photometrie | Fotometria

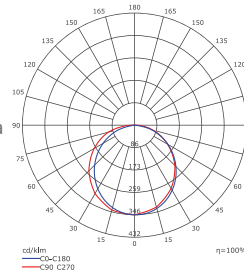

120°

Ángulo apertura  
Beam angle  
Ângulo de abertura

## LED BULKHEAD LIGHT

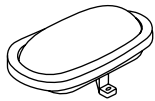

**2**  
YEAR  
WARRANTY

**30,000H**

**CRI**  
>80

**120°**

**IP64**

**-25° | +45°**

**SMD**

**20 PCS**



Model	SKU	Color	mm	kg	Power	C.Temp	Lumens	Input	€*
-------	-----	-------	----	----	-------	--------	--------	-------	----

\*Ecoraee incluída | included | incluída \* IVA no incluído | VAT not included | IVA não incluído

FT-9015	F9096	White	216x142x79	0,18	11W	4.000K	770	220-240V, 50/60Hz	18,37 €
---------	-------	-------	------------	------	-----	--------	-----	----------------------	---------

Fotometría | Photometrie | Fotometria

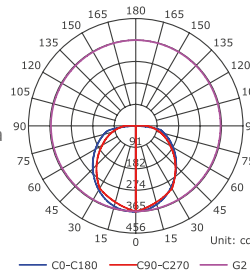



090-093

Luminaria solar  
Solar luminaire  
Luminária solar

094-099

Paneles  
Panels  
Painéis

100-108

Tubos  
Tubes  
Tubos

109-121

Tiras  
Strips  
Fitas

122-140

Bombillas  
Bulbs  
Lâmpadas

## LED BULKHEAD LIGHT

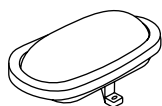
**2**  
YEAR  
WARRANTY  
**30.000H****CRI**  
**>80**  
**120°****IP64****-25° | +45°****SMD****20 PCS**

Model	SKU	Color	mm	kg	Power	C.Temp	Lumens	Input	€*
*Ecoraee incluída   included   incluída * IVA no incluído   VAT not included   IVA não incluído									
FT-9015	F9097	Black	216x142x79	0,18	11W	4.000K	770	220-240V, 50/60Hz	18,37 €

Fotometría | Photometrie | Fotometria

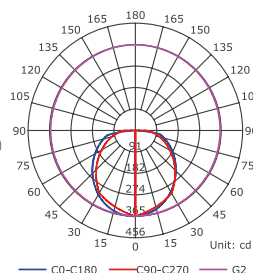
**120°**

Ángulo apertura  
Beam angle  
Ângulo de abertura

020-031

Campanas  
High bays  
Campânulas

032-046

Farolas  
Streetlights  
Viárias

047-055

Proyectores  
Floodlights  
Pojetores

056-075

Downlights  
Downlights  
Downlights

076-084

Sensores  
Sensors  
Sensores

085-089

Lum. emergencia  
Emergency lum.  
Lum. emergência

## PIR SENSOR DOWNLIGHT

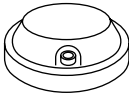

**2**  
YEAR  
WARRANTY

**30.000H**

**CRI**  
>80

**120°**

**20 PCS**



IP54



-25° | +45°

MAINTAINED/  
NON MAINTAINED

**60/75s**  
SWITCHED  
ON TIME



SMD



Model	SKU	Color	mm	kg	Power	C.Temp	Lumens	Input	€*
-------	-----	-------	----	----	-------	--------	--------	-------	----

\*Ecorae incluída | included | incluída \* IVA no incluído | VAT not included | IVA não incluído

FT-9230	F9210	White	Ø200x55	0,24	18W	4.000K	1260	220-240V, 50/60Hz	30,51 €
---------	-------	-------	---------	------	-----	--------	------	----------------------	---------

Fotometría | Photometrie | Fotometria

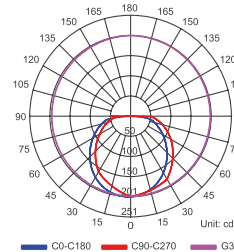

120°

Ángulo apertura  
Beam angle  
Ângulo de abertura

090-093

Luminaria solar  
Solar luminaire  
Luminária solar

094-099

Paneles  
Panels  
Painéis

100-108

Tubos  
Tubes  
Tubos

109-121

Tiras  
Strips  
Fitas

122-140

Bombillas  
Bulbs  
Lâmpadas

## SURFACE W/MOTION PIR SENSOR

Plafón con sensor de movimiento, de fácil instalación, sin parpadeos, gran tolerancia a temperatura extremas. Perfecto para grandes áreas. Lámpara automática con sensor de ahorro energético. Reúne automatismo, comodidad, seguridad, ahorro de energía y funciones prácticas.

Ceiling with motion sensor, easy installation, no flickering, great tolerance to extreme temperatures Perfect for large areas. Automatic lamp with energy-saving sensor. Combination of comfort, safety, energy saving and practical functions.

Plafonier de teto com sensor de movimento, fácil instalação, sem cintilação, grande tolerância a temperaturas extremas. Perfeito para grandes áreas. Lâmpada automática com sensor de poupança de energia. Mais conforto, segurança, economia de energia e funções práticas.

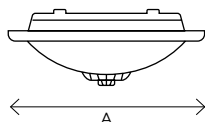
**2x**

E27

**2**  
YEAR  
WARRANTYMOTION  
SENSOR

IP20



360°



5 PCS



Model	SKU	mm	kg	Power	Input	Delay Time	Distance Detect.	Speed	Ambient Light	Install. Height	€*
FT-9230	F9203	Ø 300	96,8	0,66	2X E27	220-240V, 50/60Hz	6m Max (<24°C)	0,6-1,5m/s	<3-2000lux (Aj/adj)	2,2-4m	38,34 €

Retardo  
AtrasoDetec. distancia  
Detec. distanciaVelocidad  
VelocidadeLuz Ambiente  
Luz AmbienteAltura de  
instalación  
Altura de  
instalação

A B

\*Ecorae incluida | included | incluída \* IVA no incluido | VAT not included | IVA não incluído



076-084



Sensores

Sensors

Sensores



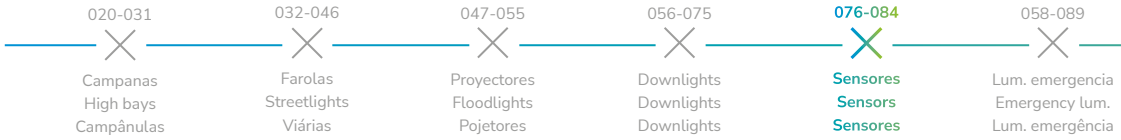

## INDOOR SURFACE-RECESSED PIR SENSOR

FT-9210 consta de un buen detector de sensibilidad y circuito integrado. Reúne automatismo, comodidad, seguridad, ahorro de energía y funciones prácticas. Utiliza la energía infrarroja del ser humano como fuente de señal de control y puede iniciar la carga de una vez cuando se entra en el campo de detección. Puede identificar día y noche automáticamente.

FT-9210 consists of a good sensitivity detector and integrated circuit. It combines automatism, comfort, safety, energy saving and practical functions. It uses the human's infrared energy as the control signal source and can start charging once when entering the detection field. You can automatically identify day and night.

FT-9210 consiste em um bom detector de movimento combina automação, conforto, segurança, economia de energia e funções práticas. Usa a energia infravermelha do ser humano como uma fonte de sinal de controle e se pode iniciar a partir do momento que detecta algo no campo de detecção. Permite identificar o dia e a noite automaticamente.

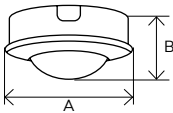

**2**  
YEAR  
WARRANTY



Model	SKU	mm	kg	Power	Input	Delay Time	Distance Detect.	Speed	Ambient Light	Install. Height	€*
-------	-----	----	----	-------	-------	------------	------------------	-------	---------------	-----------------	----

Retardo  
Atraso

Detec. distancia  
Detec. distancia

Velocidad  
Velocidade

Luz Ambiente  
Luz Ambiente

Altura de  
instalación  
Altura de  
instalação

A		B		*Ecorae incluida   included   incluída * IVA no incluido   VAT not included   IVA não incluído								
FT-9210	F9201	Out Ø 80 In Ø 61,5	Out 39,6 In 37,1	0,18	Max. 800W 400W	220-240V, 50/60Hz	Min. 10 sec ± 3sec  Max. 30min ± 2min	8m Max (<24°C)	0,6-1,5m/s	<3-2000lux (Aj/adj)	2,2-4m	17,56 €

090-093

Luminaria solar  
Solar luminaire  
Luminária solar

094-099

Paneles  
Panels  
Painéis

100-108

Tubos  
Tubes  
Tubos

109-121

Tiras  
Strips  
Fitas

122-140

Bombillas  
Bulbs  
Lâmpadas

## OUTDOOR SURFACE PIR SENSOR

FT-9220 Detector de buena sensibilidad y circuito integrado. Reúne automatismo, comodidad, seguridad, ahorro de energía y funciones prácticas. Puede identificar día y noche automáticamente. Es fácil de instalar y utilizar ampliamente.

FT-9220 Good sensitivity detector and integrated circuit. It gathers automatism, convenience, safety, saving-energy and practical functions. It can identify day and night automatically. It is easy to install and used widely.

FT-9220 detector de boa sensibilidade. Combina automação, conforto, segurança, economia energia e funções práticas. Pode identificar dia e noite automaticamente é fácil de instalar e usar.

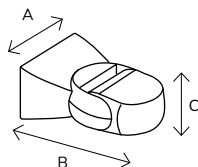

**2**  
YEAR  
WARRANTY



Model	SKU	mm	kg	Power	Input	Delay Time	Distance Detect.	Speed	Ambient Light	Install. Height	€*	
						Retardo Atraso	Detec. distancia Detec. distancia	Velocidad Velocidade	Luz Ambiente Luz Ambiente	Altura de instalación Altura de instalação		
		A	B	C			*Ecoraee incluida   included   incluída * IVA no incluido   VAT not included   IVA não incluído					
FT-9220	F9202	80	119,5	51,5	0,18	Max. 1200W 300W	220- 240V, 50/60Hz	Min. 10 sec ± 3sec Max. 15min ± 2min	12m Max (<24°C)	0,6-1,5m/s	<3-2000lux (Aj/adj)	1,8-2,5 m 18,70 €

020-031 Campanas High bays Campânulas	032-046 Farolas Streetlights Viárias	047-055 Proyectores Floodlights Pojetores	056-075 Downlights Downlights Downlights	<b>076-084</b> <b>Sensores</b> <b>Sensors</b> <b>Sensores</b>	058-089 Lum. emergencia Emergency lum. Lum. emergência
--	---	--	---	--	---

## SURFACE PIR SENSOR

F9204-F9205 Buen detector de sensibilidad y circuito integrado. Reúne automatismo, conveniencia, seguridad, ahorro de energía y funciones prácticas. Utiliza la energía infrarroja del ser humano como fuente de señal de control y puede iniciar la carga de inmediato cuando uno entra al campo de detección. Puede identificar día y noche automáticamente. Es fácil de instalar y se usa ampliamente.

F9204-F9205 Good sensitivity detector and integrated circuit. It gathers automatism, convenience, safety, saving-energy and practical functions. It utilizes the infrared energy from human as control-signal source and it can start the load at once when one enters detection field. It can identify day and night automatically. It is easy to install and used widely.

F9204-F9205 Detector de movimento por infravermelho passivo (IR). Mede a luz infravermelha que é irradiada pelos objectos existentes no seu campo. Geralmente são utilizados em alarmes de segurança e/ou aplicações de iluminação automática.

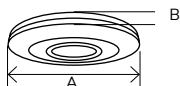

**2**  
YEAR  
WARRANTY



Model	Sku	Color	mm	kg	Power	Input	Delay Time	Distance Detect.	Speed	Ambient Light	Install. Height	€*
-------	-----	-------	----	----	-------	-------	------------	------------------	-------	---------------	-----------------	----

Retardo    Detec. distancia    Velocidad    Luz Ambiente    Altura de instalación  
Atraso    Detec. distancia    Velocidade    Luz Ambiente    Altura de instalação

Altura de  
instalação

A    B

\*Ecoraee incluida | included | incluída \* IVA no incluido | VAT not included | IVA não incluído

Model	Sku	Color	mm	kg	Power	Input	Delay Time	Distance Detect.	Speed	Ambient Light	Install. Height	€*
FT-9240	F9204	Black	Ø 115	24,3	0,18	220-240V, 50/60Hz	Max. 2000W	8m Max (<24°C)	0,6-1,5m/s	<3-2000lux (Aj/adj)	2,2-4m	17,65 €
	F9205	White					Min. 10 sec ± 3sec					



090-093

Luminaria solar  
Solar luminaire  
Luminária solar

094-099

Paneles  
Panels  
Painéis

100-108

Tubos  
Tubes  
Tubos

109-121

Tiras  
Strips  
Fitas

122-140

Bombillas  
Bulbs  
Lâmpadas

## LIGHT SENSOR. PHOTOCELL

El sensor de luz F9206 puede encender o apagar la luz automáticamente de acuerdo con la luz ambiental. La temperatura ambiente y la humedad no pueden afectarlo. No solo es conveniente sino también práctico; puede controlar la carga trabajando solo de noche. Se utiliza para luz de carretera, luz de jardín, etc.

F9206 Light sensor can turn on or turn off light automatically according to ambient-light. Ambient temperature and humidity can't affect it. It is not only convenient but also practical; it can control the load working only at night. It is used for road light, garden light etc.

O detector de luz F9206, permite ligar ou desligar a luz automaticamente, dependendo da luz existente na sua zona de actuação. A temperatura ambiente e a quantidade de humidade podem afectar o seu modo de funcionamento. Geralmente são usados em iluminação exterior, em jardins, etc...

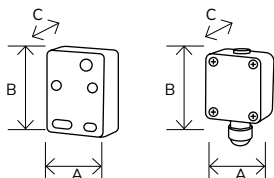
**2**  
YEAR  
WARRANTYMOTION  
SENSOR

50 PCS



Model	Sku	mm			Rated current	Input	Temperature	Humidity	Ambient Light	€*
					Corriente nominal Corrente nominal		Temperatura Temperatura	Humedad Umidade	Luz Ambiente Luz Ambiente	
		A	B	C	*Ecorae incluida   included   incluída * IVA no incluido   VAT not included   IVA não incluído					
FT-9240	F9206	48	63,4	27,3	15A	220-240V, 50Hz	-20 ~+40°C	<93%RH	<2-100lux (A/adj)	17,35 €
		42,1	47,9	28,8						



## RECESSED MICROWAVE INDOOR SENSOR

F9207 Molde de sensor de microondas con onda electromagnética de alta frecuencia (5.8GHz) y circuito integrado. Automatismo, comodidad, seguridad y ahorro de energía. Amplio campo de detección. Funciona con el movimiento humano. Cuando uno entra al campo de detección, puede iniciar la carga de inmediato e identificar automáticamente día y noche. La detección es posible a través de puertas, paneles de vidrio o paredes delgadas.

F9207 Microwave sensor mould with high-frequency electro-magnetic wave (5.8GHz) and integrated circuit. Automatism, convenience, safety, and saving-energy. Wide detection field. It works by receiving human motion. When one enters the detection field, it can start the load at once and identify automatically day and night. Detection is possible to go through doors, panes of glass or thin walls.

Detector de movimento por Micro-ondas F9207. Detecta movimento como um radar, detecta as várias mudanças de estado refletidas devido ao movimento de um objecto resultando num sinal e assim fazer o modo on ou off. Geralmente são usados para acionar as luzes da rua ou de interior, em halls, corredores, escadas, ect.

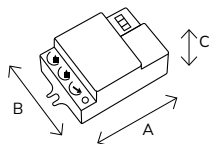

**2**  
YEAR  
WARRANTY

**MOTION  
SENSOR**

**IP20**

**180°x360°**

**100 PCS**



Model	SKU	mm	Power	Input	Delay Time	Distance Detect.	Speed	Ambient Light	Install. Height	€*
-------	-----	----	-------	-------	------------	------------------	-------	---------------	-----------------	----

Retardo  
Atraso

Detec. distancia  
Detec. distancia

Velocidad  
Velocidade

Luz Ambiente  
Luz Ambiente

Altura de  
instalación  
Altura de  
instalação

A B C \*Ecorae incluida | included | incluída \* IVA no incluido | VAT not included | IVA não incluído

FT-9240	F9207	54,5	39,4	25	 Max. 1200W  300W	220- 240V, 50/60Hz	Min. 10sec ± 3sec  Max. 12min ± 1min	Wall: 5-15m (adjustable)  Ceiling: 1-8m (radius), adjustable	0,6-1,5m/s	<3-2000lux (Aj/adj)	Wall 5-15m (Aj/adj)  Ceiling: 1-8m (radius) (Aj/adj)	19,14 €
---------	-------	------	------	----	-------------------------------	--------------------------	--	---	------------	------------------------	---	---------

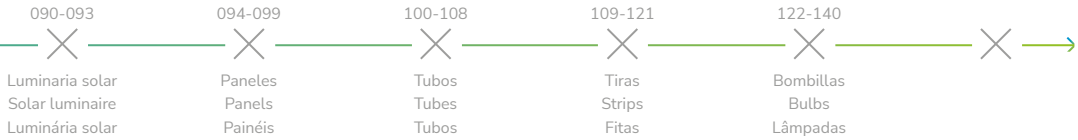

## RECESSED PIR SENSOR

F9208 Detector de buena sensibilidad y circuito integrado. Reúne automatismo, comodidad, seguridad y ahorro de energía. Utiliza la energía infrarroja del ser humano como fuente de señal de control y puede iniciar la carga de inmediato cuando uno entra al campo de detección. Puede identificar día y noche automáticamente. Es fácil de instalar y sencillo de usar.

F9208 Good sensitivity detector and integrated circuit. It gathers automatism, convenience, safety, saving-energy and practical functions. It utilizes the infrared energy from human as control-signal source and it can start the load at once when one enters detection field. It can identify day and night automatically. It is easy to install and used widely.

F 9208 Detector de movimento por infravermelho passivo (IR). Mede a luz infravermelha que é irradiada pelos objectos existentes no seu campo. Geralmente são utilizados em alarmes de segurança e/ou aplicações de iluminação automática.

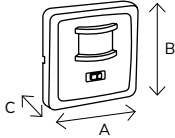

**2**  
YEAR  
WARRANTY

**MOTION  
SENSOR**

**IP20**

**160°**

**100 PCS**



Model	SKU	mm	Power	Input	Delay Time	Distance Detect.	Speed	Ambient Light	Install. Height	€*
-------	-----	----	-------	-------	------------	------------------	-------	---------------	-----------------	----

Retardo Detec. distancia Velocidad Luz Ambiente  
Atraso Detec. distancia Velocidade Luz Ambiente

Altura de  
instalación  
Altura de  
instalação

A B C			*Ecorae incluida   included   incluída * IVA no incluido   VAT not included   IVA não incluído									
FT-9240	F9208	82	82	24,7	Max. 500W 200W	220- 240V, 50/60Hz	Min. 10sec ± 3sec Max. 7min ± 2min	9m Max (<24°C)	0,6-1,5m/s	<3-2000lux (Aj/adj)	1-1,8m	17,10 €

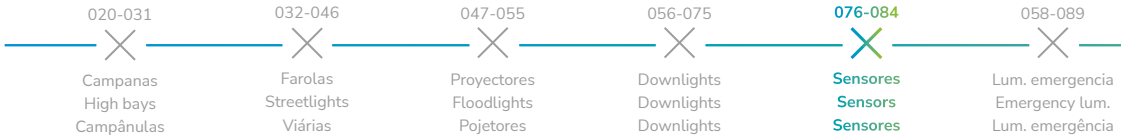

# PIR SENSOR WALL LIGHT

F9209 Buen detector de sensibilidad y circuito integrado. Reúne automatismo, conveniencia, seguridad, ahorro de energía y funciones prácticas. Utiliza la energía infrarroja del ser humano como fuente de señal de control y puede iniciar la carga de inmediato cuando uno entra al campo de detección. Puede identificar día y noche automáticamente. Es fácil de instalar y se usa ampliamente.

F9209 Good sensitivity detector and integrated circuit. It gathers automatism, convenience, safety, saving-energy and practical functions. It utilizes the infrared energy from human as control-signal source and it can start the load at once when one enters detection field. It can identify day and night automatically. It is easy to install and used widely.

F 9209 Detector de movimento por infravermelho passivo (IR). Mede a luz infravermelha que é irradiada pelos objectos existentes no seu campo. Geralmente são utilizados em alarmes de segurança e/ ou aplicações de iluminação automática.

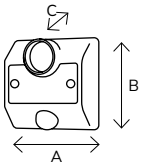

1x  
E27

2  
YEAR  
WARRANTY

MOTION  
SENSOR

IP20

360°

50 PCS



Model	Sku	mm	Power	Input	Delay Time	Distance Detect.	Ambient Light	Install. Height	€*
-------	-----	----	-------	-------	------------	------------------	---------------	-----------------	----

Re-  
tardo  
Atraso

Detec. distancia  
Detec. distancia

Luz Ambiente  
Luz Ambiente

Altura de instalación  
Altura de instalação

		A	B	C	*Ecorae incluida   included   incluída * IVA no incluido   VAT not included   IVA não incluído						
FT-9240	F9209	85,5	85,5	38	Max. 60W (E27)	110- 240V, 50/60Hz	Min. 10 sec ± 3sec  Max 5min ± 2min	Wall: 6m Max (<24°C)  Ceiling: 6m Max (<24°C)	<3-2000lux (Aj/adj)	Wall 1,8-2,5m  Ceiling: 2,2-4m	16,18 €



085-89



Luminaria de emergencia

Emergency luminaire

Luminária de emergência



LUM.EMERGENCIA | EMERGENCY LUM. | LUM. EMERGÊNCIA

020-031  
Campanas  
High bays  
Campânulas

032-046  
Farolas  
Streetlights  
Viárias

047-055  
Proyectores  
Floodlights  
Pojetores

056-075  
Downlights  
Downlights  
Downlights

076-084  
Sensores  
Sensors  
Sensores

085-089  
Lum. emergencia  
Emergency lum.  
Lum. emergência

## LED EMERGENCY LAMP

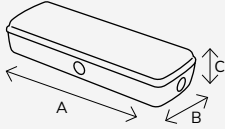

**2**  
YEAR  
WARRANTY

**LITHIUM  
BATTERY**

**MAINTAINED/  
NON MAINTAINED**

**CRI  
80**

**3H  
EMERGENCY  
DURATION**

**24H  
FULL CHARGE  
TIME**

**220-240V  
60HZ**

**SMD**

**IP20**



Model	SKU	mm			kg	Power	C.Temp	Lumens	IP	Battery	€*
		A	B	C							
FT-7000	F7010	260	95	55	0,34	3W	6.000K	100	20	3,7V 1200mAh	32,73 €

\*Ecoraee incluida | included | incluída  
\* IVA no incluido | VAT not included | IVA não incluido

### Accesorios | Accessories | Acessórios

\*Ecoraee incluida | included | incluída  
\* IVA no incluido | VAT not included | IVA não incluido



**FT-7000/F7011** **6,70 €\*  
Marco de empotrar  
Recession kit  
Kit de recessão**



**FT-7000/F7012** **15,85 €\*  
Difusor  
Diffuser  
Difusor**



**FT-7000/F7017** **0,80 €\*  
Pegatina para difusor  
Adhesive for diffuser  
Adesivo para difusor**

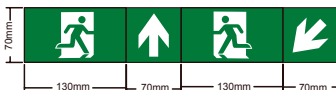

**FT-7000/F7018** **1,34 €\*  
Pegatina para difusor  
Adhesive for diffuser  
Adesivo para difusor**

090-093

Luminaria solar  
Solar luminaire  
Luminária solar

094-099

Paneles  
Panels  
Painéis

100-108

Tubos  
Tubes  
Tubos

109-121

Tiras  
Strips  
Fitas

122-140

Bombillas  
Bulbs  
Lâmpadas

## LED EMERGENCY LAMP

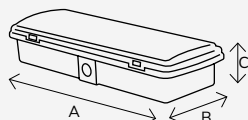
**2**  
YEAR  
WARRANTY**CRI**  
80**3H**  
EMERGENCY  
DURATION**24H**  
FULL CHARGE  
TIME**220-240V**  
60HZ

Model	SKU	mm			kg	Power	C.Temp	Lumens	IP	Battery	€*
		A	B	C							
FT-7000	F7013	270	100	54	0,46	4,4W	6.000K	400	65	7,2V 1500mAh	55,24 €

\*Ecorae incluida | included | incluída

\* IVA no incluido | VAT not included | IVA não incluído

### Accesorios | Accessories | Acessórios

\*Ecorae incluida | included | incluída

\* IVA no incluido | VAT not included | IVA não incluído



FT-7000/F7014

7,69 €\*  

---

Marco de empotrar  
Recession kit  
Kit de recessão

FT-7000/F7016

21,24 €\*  

---

Difusor  
Diffuser  
Difusor

FT-7000/F7015

5,16 €\*  

---

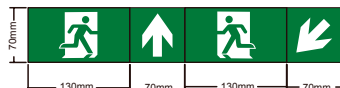
Carcasa de encastrar  
Embed box  
Caixa de embutir

FT-7000/F7018

1,34 €\*  

---

Pegatina para difusor  
Adhesive for diffuser  
Adesivo para difusor

FT-7000/F7017

0,80 €\*  

---

Pegatina para difusor  
Adhesive for diffuser  
Adesivo para difusor

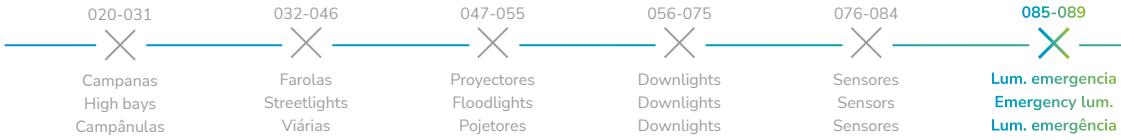

## LED EMERGENCY DOWNLIGHT

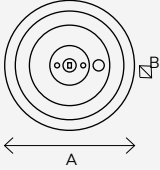

**2**  
YEAR  
WARRANTY

**AUTOTEST**

**MAINTAINED/  
NON MAINTAINED**

**CRI**  
80

**3H**  
EMERGENCY  
DURATION

**24H**  
FULL CHARGE  
TIME

**220-240V**  
60HZ

**LiFePO<sub>4</sub>**  
BATTERY

**IP20**



Model	SKU	mm		kg	Power	C.Temp	Lumens	IP	Battery	€*	
		A	B	Cut							
FT-7000	F7020	Ø 85 / Ø 140	23	Ø 65	0,23	3,5W	4.000K	150	20	3,2v 1,5Ah	46,69 €

\*Ecoraee incluída | included | incluída  
\* IVA no incluído | VAT not included | IVA não incluído

## LED EMERGENCY LAMP

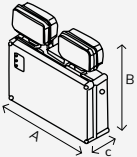

**2**  
YEAR  
WARRANTY

**AUTOTEST**

**NON MAINTAINED**

**CRI**  
80

**IP65**

**3H**  
EMERGENCY  
DURATION

**24H**  
FULL CHARGE  
TIME

**220-240V**  
60HZ

**Ni-cd**  
BATTERY



Model	SKU	mm			kg	W	C.Temp	Lumens	IP	Battery	€*
		A	B	C							
FT-7000	F7019	300	294	77	1,90	10,5W	6.000K	650	65	12V 2800mAh	186,43 €

\*Ecoraee incluída | included | incluída  
\* IVA no incluído | VAT not included | IVA não incluído



090-093

Luminaria solar  
Solar luminaire  
Luminária solar

094-099

Paneles  
Panels  
Painéis

100-108

Tubos  
Tubes  
Tubos

109-121

Tiras  
Strips  
Fitas

122-140

Bombillas  
Bulbs  
Lâmpadas

## EMERGENCY KIT

Protección contra sobrettemperatura  
Over Temperature Protection  
Proteção contra superaquecimento



**3**  
YEAR  
WARRANTY

**AUTOTEST**

**0° | +50°**

**IP65**

**3H**  
EMERGENCY  
DURATION

**36H**  
FULL CHARGE  
TIME

**100-240V**  
50/60HZ

**LITHIUM**  
BATTERY

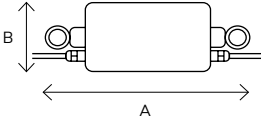

Interruptor de prueba e indicador de carga  
Test switch and charge indicator  
Interruptor de teste e indicador de carga

Compatible con  
Compatible with  
Compatível com

F6018  
F6019  
F6020  
F6021

Model	SKU	mm		kg	Power	IP	Output	€*
		A	B					
FT-6000	F6031	280	100	2,62	30W	65	230V	436,55 €

\*Ecorae incluida | included | incluída  
\* IVA no incluido | VAT not included | IVA não incluido

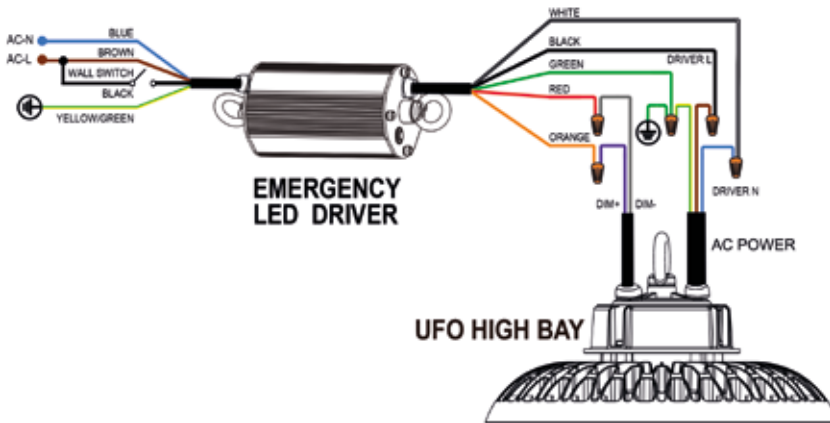

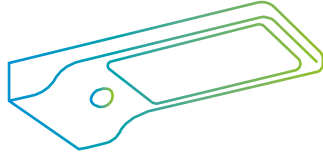

092-095



Luminaria solar  
Solar luminaire  
Luminária solar

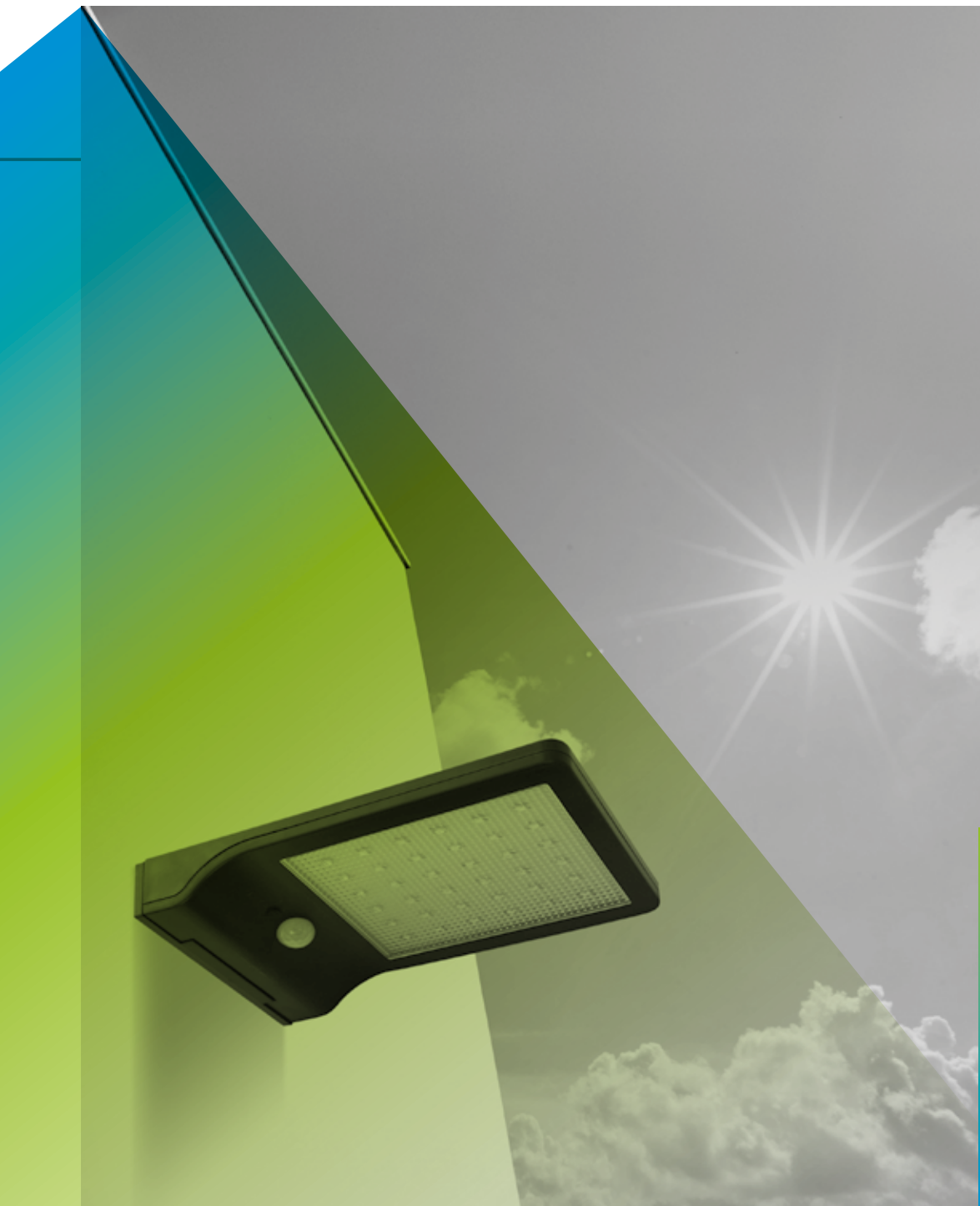

LUM. SOLAR | SOLAR LUM. | LUM. SOLAR

020-031

Campanas  
High bays  
Campânulas

032-046

Farolas  
Streetlights  
Viárias

047-055

Proyectores  
Floodlights  
Pojetores

056-075

Downlights  
Downlights  
Downlights

076-084

Sensores  
Sensors  
Sensores

085-089

Lum. emergencia  
Emergency lum.  
Lum. emergência

## PIR SENSOR SOLAR LED WALL LIGHT

La lámpara de pared solar LED es una unidad de luz de sensor compacta. Incorpora un sensor PIR automático para controlar los LED. Se puede utilizar para proporcionar iluminación para cualquier propósito general en una variedad de ubicaciones en el hogar o el lugar de trabajo.

The LED Solar Wall Light is a compact sensor light unit. It incorporates an automatic PIR sensor to control LEDs. It can be used to provide lighting for any general purposes in a variety of locations around the home or workplace.

Projector de LED Solar de parede com sensor. Dispõe de um sensor PIR automático para controlo de Led. Pode ser utilizado em diversas aplicações, tais como, habitações, zonas de passagem, etc.

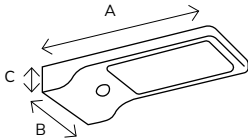

**2**  
YEAR  
WARRANTY

**POWERED  
BY THE SUN**

**TURNS ON  
AT DUSK**

**LITHIUM  
BATTERY**

**110°**

**CRI**  
80

**IP44**

**MOTION  
SENSOR**

**7H**  
FULL CHARGE  
TIME

**40 PCS**

**SMD**



Model	SKU	mm	kg	Color	Power	C.Temp	Lumens	Delay time	Distance	Battery	€*		
		A	B	C									
FT-5001	F5270	192	110	30	0,26	Black	3W	4.000K	400	25s ±5s	6 m	3,7V 2000mAh	33,74 €
	F5271					White							

\*Ecoraee incluída | included | incluída  
\* IVA no incluído | VAT not included | IVA não incluído

090-093



Luminaria solar  
Solar luminaire  
Luminária solar

094-099



Paneles  
Panels  
Painéis

100-108



Tubos  
Tubes  
Tubos

109-121



Tiras  
Strips  
Fitas

122-140



Bombillas  
Bulbs  
Lâmpadas



## PIR SOLAR LED STREET GARDEN LIGHT

Energía solar, coste de electricidad de 0€. Sensor PIR, ángulo detectado 120°, alta sensibilidad. Control remoto para DIY y brillo, combina fácilmente con diferentes aplicaciones. Gran capacidad de batería LiFePO4, tiempo de trabajo prolongado. Ampliamente utilizado como luz de jardín, luz de seguridad, luz de calle, etc.

Solar powered, \$0 electricity cost. PIR sensor, detected angle 120°, high sensitivity. Remote control to DIY time and brightness, easily match different applications. Big battery capacity LiFePO4, long working time. Widely used as garden light, security light, street light etc.

Energia solar, eletricidade custa 0€. Sensor PIR, ângulo detectado de 120°, alta sensibilidade. Controle remoto para DIY e glitter, combine facilmente com diferentes aplicações. Bateria LiFePO4, longo tempo de trabalho. Muito utilizado como luz de jardim, luz de segurança, luz de rua, etc.



Montaje: en poste vertical | horizontal | en superficie  
Installation: on vertical pole | horizontal | on surface  
Montagem: em poste vertical | horizontal | na superfície

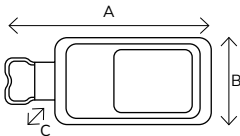

**2**  
YEAR  
WARRANTY



POWERED  
BY THE SUN



TURNS ON  
AT DUSK



LiFePO<sub>4</sub>  
BATTERY



140°x70°

CRI  
80



IP65



MOTION  
SENSOR



4 PCS



SMD



Model	Sku	mm			kg	Color	Power	C.Temp	Lumens	Distance	Battery	€*
		A	B	C								
FT-5002	F5272	621	289	73	0,26	Black	40W	4.000K	4.800	3-7 m	9,6V 12.000mAh	386,38 €

\*Ecorae incluida | included | incluída

\* IVA no incluido | VAT not included | IVA não incluído



096-101



Paneles

Panels

Painéis

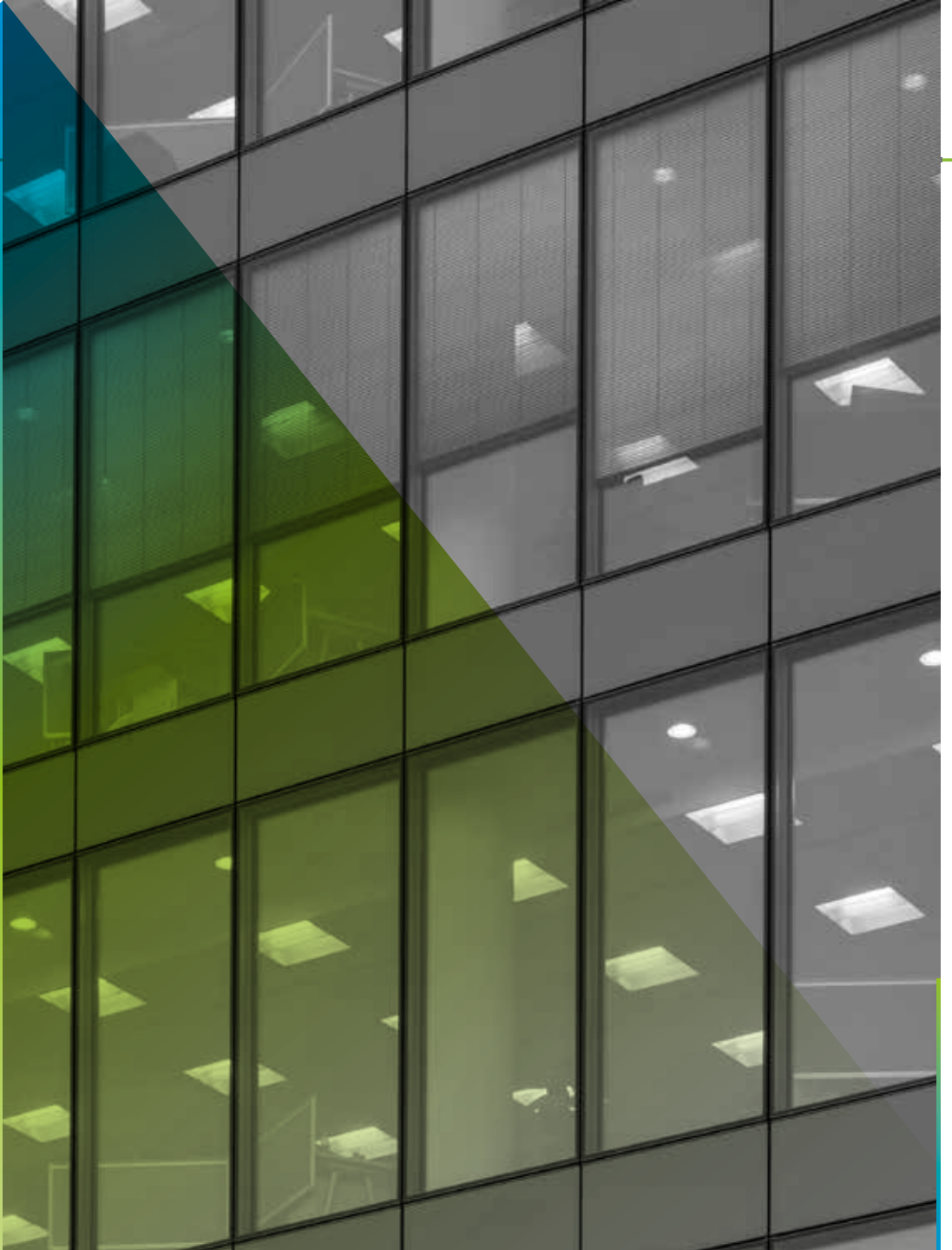

020-031

Campanas  
High bays  
Campânulas

032-046

Farolas  
Streetlights  
Viárias

047-055

Proyectores  
Floodlights  
Pojetores

056-075

Downlights  
Downlights  
Downlights

076-084

Sensores  
Sensors  
Sensores

085-089

Lum. emergencia  
Emergency lum.  
Lum. emergência

## LED PANEL 600X600

Los paneles UGR LED PRO, brindan una luz ideal para oficinas, tiendas, hoteles, hospitales, escuelas e institutos. Aportando un mayor confort visual con su difusor que asegura una salida luminosa homogénea, asegurando en todos los puntos el factor de deslumbramiento UGR<19.

UGR LED PRO panels provide an ideal light for offices, shops, hotels, hospitals, schools and institutes. Providing greater visual comfort with its diffuser that ensures a homogenous light output, ensuring at all points the glare factor UGR <19.

Os painéis UGR LED PRO fornecem uma luz ideal para escritórios, lojas, hotéis, hospitais, escolas e institutos. Proporcionando maior conforto visual com seu difusor que garante uma saída de luz homogênea, garantindo em todos os pontos o fator de brilho UGR <19.

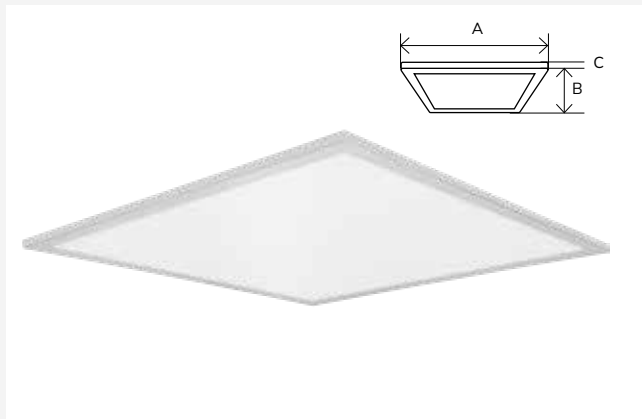
**5**  
YEAR  
WARRANTY**50.000H****CRI**  
>80**110°****PF**  
>0,9**IP20****110LM/W****UGR**  
<19**SMD****6 PCS**

Driver no incluido | Driver not included | Driver não incluído



Model	Sku	mm	kg	Power	C.Temp	Lumens	Input	€*		
		A	B	C						
FT-8600	F8040	595	595	8	2,1	30-40-44W	4.000K	3.300 ; 4.400 ; 4.840	220-240V, 50/60Hz	81,53 €
	F8041					6.000K				

\*Ecorae incluida | included | incluída  
\* IVA no incluido | VAT not included | IVA não incluído

Driver para completar tu panel | Driver to complete your panel | Driver para completar seu painel



FT-8000/F8046

15,68 €\*  
Philips driver 44W Flicker free

FT-8000/F8019

14,68 €\*  
Lifud driver 30W LF-GIR030YM

FT-8000/F8021

96,53 €\*  
Lifud driver 40W Dali/0-10V LF-GSD042YA

Accesorios | Accessories | Acessórios

\*Ecorae incluida | included | incluída  
\* IVA no incluido | VAT not included | IVA não incluído

FT-8000/F8007

28,31 €\*  
Kit de superficie para panel 600x600  
Surface kit for 600x600 panel  
Kit de superfície para panel 600x600

FT-8000/F8009

12,35 €\*  
Kit de suspensión para panel 600x600  
Suspension kit for 600x600 panel  
Kit de suspensão para painel 600x600

FT-8000/F8030

32,86 €\*  
Marco para empotrar para panel 600x600  
Recessed frame for 600x600 panel  
Moldura de encastrar para painel 600x600



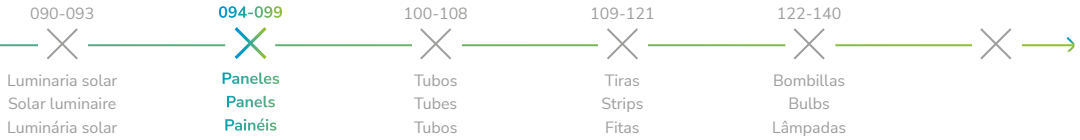

# LED PRO PANEL 1200X300

Los paneles LED PRO de Filux te permitirán crear un ambiente muy luminoso y actual por su diseño integrado y elegante. La duración de los paneles LED es mucho mayor que la de los paneles convencionales, por eso es una elección recomendada si buscamos un sistema lumínico para nuestra estancia.

The Filux LED PRO panels will allow you to create a very bright and contemporary environment due to its integrated and elegant design. The length of LED panels is much longer than conventional panels.

Os painéis LED PRO 5 anos de garantia Filux, permitem criar um ambiente muito brilhante e moderno devido ao seu design integrado e elegante. A sua aplicação é ampla e variada. A duração dos painéis de LED é maior do que os painéis convencionais.

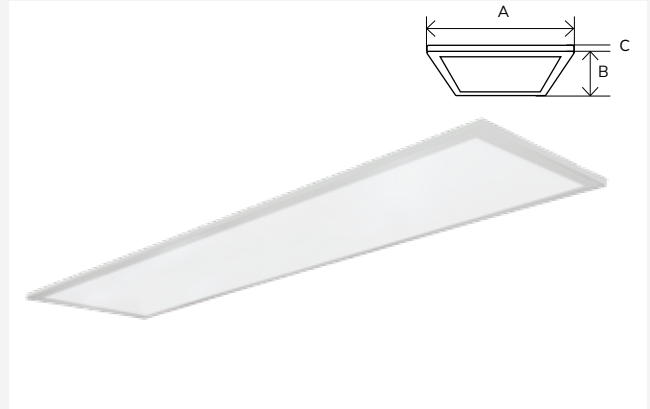

Driver no incluido | Driver not included | Driver não incluído



Model	Sku	mm			kg	Power	C.Temp	Lumens	Input	€*
		A	B	C						
FT-8123	F8042	1195	295	8	2,5	30-40-44W	4.000	3.300 ; 4.400 ; 4.840	220-240V, 50/60Hz	93,63 €
	6.000									

\*Ecoraee incluida | included | incluída  
\* IVA no incluido | VAT not included | IVA não incluído

Driver para completar tu panel | Driver to complete your panel | Driver para completar seu painel



FT-8000/F8046

15,68 €\*  
Philips driver 44W Flicker free



FT-8000/F8019

14,68 €\*  
Lifud driver 30W LF-GIR030YM



FT-8000/F8021

96,53 €\*  
Lifud driver 40W Dali/0-10V LF-GSD042YA

Accesorios | Accessories | Acessórios

\*Ecoraee incluida | included | incluída  
\* IVA no incluido | VAT not included | IVA não incluído



FT-8000/F8008

37,55 €\*  
Kit de superficie para panel 1.200X300  
Surface kit for 1.200X300 panel  
Kit de superficie para painel 1.200X300



FT-8000/F8013

19,27 €\*  
Kit de suspensión para panel 1.200X300  
Suspension kit for 1.200X300 panel  
Kit de suspensão para painel 1.200X300



FT-8000/F8031

40,22 €\*  
Marco para empotrar para panel 1.200x300  
Recessed frame for 1.200x300 panel  
Moldura de encastrar para painel 1.200x300

020-031

Campanas  
High bays  
Campânulas

032-046

Farolas  
Streetlights  
Viárias

047-055

Proyectores  
Floodlights  
Pojetores

056-075

Downlights  
Downlights  
Downlights

076-084

Sensores  
Sensors  
Sensores

085-089

Lum. emergencia  
Emergency lum.  
Lum. emergência

## LED PANEL 1200X600

Los paneles LED PRO de Filux te permitirán crear un ambiente muy luminoso y actual por su diseño integrado y elegante. La duración de los paneles LED es mucho mayor que la de los paneles convencionales, por eso es una elección recomendada si buscamos un sistema lumínico para nuestra estancia.

The Filux LED PRO panels will allow you to create a very bright and contemporary environment due to its integrated and elegant design. The length of LED panels is much longer than conventional panels.

Os painéis LED PRO 5 anos de garantia Filux, permitem criar um ambiente muito brilhante e moderno devido ao seu design integrado e elegante. A sua aplicação é ampla e variada. A duração dos painéis de LED é maior do que os painéis convencionais.



**5**  
YEAR  
WARRANTY

**50.000H**

**CRI**  
>80

**110°**

**PF**  
>0,9

**IP20**

**110LM/W**

**UGR**  
<19

**SMD**

**4 PCS**

Driver no incluido | Driver not included | Driver não incluído



Model	SKU	mm			kg	Power	C.Temp	Lumens	Input	€*
		A	B	C						
FT-8126	F8044	1195	595	8	4,5	60W	4.000K	6.600	220-240V, 50/60Hz	154,79 €
	F8045						6.000K			

\*Ecorae incluída | included | incluída  
\* IVA no incluído | VAT not included | IVA não incluído

Driver para completar tu panel | Driver to complete your panel | Driver para completar seu painel



**FT-8000/F8047** **38,57 €\***

Philips driver 60W Flicker free

Accesorios | Accessories | Acessórios

\*Ecorae incluída | included | incluída  
\* IVA no incluído | VAT not included | IVA não incluído



**FT-8000/F8014** **48,57 €\***

Kit de superficie para panel 1.200x600  
Surface kit for 1.200x600 panel  
Kit de superficie para painel 1.200x600

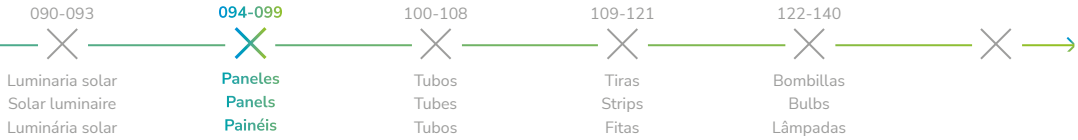

# BACKLIGHT LED PANEL 600X600

Los paneles ESSENTIAL LED de Filux te permitirán crear un ambiente muy luminoso y actual por su diseño integrado y elegante. Su aplicación es amplia y variada. La duración de los paneles LED es mucho mayor que la de los paneles convencionales, por eso es una elección recomendada si buscamos un sistema lumínico para nuestra estancia. Alternativa mucho más ecológica.

The Filux ESSENTIAL LED panels will allow you to create a very bright and contemporary environment due to its integrated and elegant design. Its application is wide and varied. The length of LED panels is much longer than conventional panels, so it is a recommended choice if we are looking for an ecological light system.

Os painéis ESSENTIAL LED Filux permitem criar um ambiente muito brilhante e moderno devido ao seu design integrado e elegante. Sua aplicação é ampla e variada. A duração dos painéis de LED é maior do que os painéis convencionais, é por isso uma escolha recomendado se procuramos um sistema de luz ecológico.



**2**  
YEAR  
WARRANTY

**25,000H**

**CRI**  
>80

**110°**

**PF**  
>0,9

Driver incluido | Driver included | Driver incluído

Model	Sku	mm			kg	Power	C.Temp	Lumens	Input	€*
		A	B	C						
FT-8600	F8028	595	595	30	1,54	40W	4.000K	3.600	220-240V, 50/60Hz	54,02 €
	F8029						6.500K			

\*Ecorae incluida | included | incluída  
\* IVA no incluido | VAT not included | IVA não incluído

## Accesorios | Accessories | Acessórios

\*Ecorae incluida | included | incluída  
\* IVA no incluido | VAT not included | IVA não incluído

**FT-8000/F8030** **32,86 €\***

Marco para empotrar para panel 600x600  
Recessed frame for 600x600 panel  
Moldura de encastrar para painel 600x600

**FT-8000/F8007** **28,31 €\***

Kit de superficie para panel 600x600  
Surface kit for 600x600 panel  
Kit de superfície para panel 600x600

**FT-8000/F8009** **12,35 €\***

Kit de suspensión para panel 600x600  
Suspension kit for 600x600 panel  
Kit de suspensão para painel 600x600

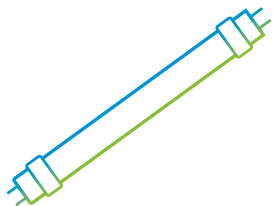

100-108



Tubos y luminarias estancas  
Tubes and waterproof luminaires  
Tubos e luminárias estanques



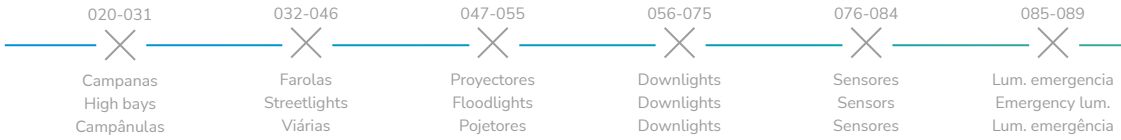

## T8 LED TUBES

Las lámparas de tubo T8 LED de Filux son de vidrio con cubierta de plástico anti rotura. Disponemos de diferentes modelos con distintas temperaturas de color, entre los que destacamos el blanco neutro, el blanco frío o el blanco cálido. Estas lámparas de tubo LED cuentan con un sistema de encendido instantáneo y aguantan temperaturas de (-20° a 45°).

Filux T8 LED tubes are made of glass with an anti-breakage plastic cover. We have different models with different color temperatures, among them we highlight the ones with neutral white, cold white or warm white. These LED tube lamps feature an instantaneous ignition system and withstand temperatures of (-20° to 45°).

Os tubos LED Filux T8 são feitos de vidro com uma tampa de plástico anti-quebra. Temos diferentes modelos com diferentes temperaturas de cor, entre os quais o branco neutro, o branco frio ou o branco quente. Estas lâmpadas de tubo LED têm um sistema temperaturas de ignição e retenção instantâneas (-20° a 45°).

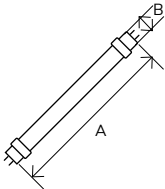
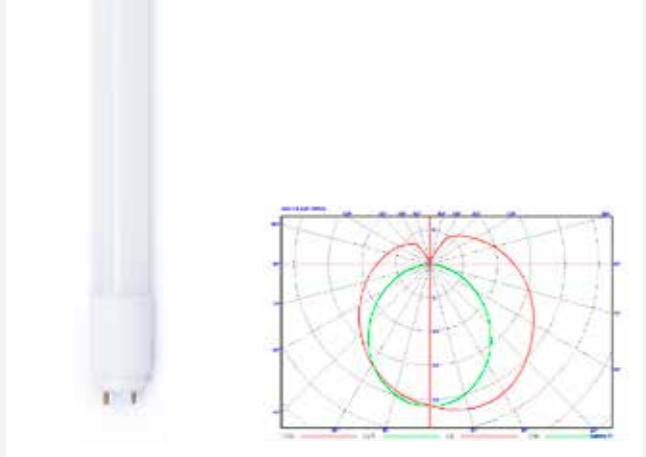

**3**  
YEAR  
WARRANTY

**25.000H**

**CRI**  
>80

**300°**

**PF**  
>0,9

**IP20**

**120LM/W**

**G13**

**25 PCS**

**SMD**



Model	SKU	mm	g	Power	C.Temp	Lumens	Input	€*
		A	B	*Ecoraee incluida   included   incluída * IVA no incluido   VAT not included   IVA não incluído				
FT-1009	F1026	600	100,9	9W	3.000K	1.080	220-240V, 50Hz	8,23 €
	F1027				4.000K			
	F1028				6.500K			
FT-1014	F1029	900	147,6	14W	3.000K	1.680		9,21 €
	F1030				4.000K			
	F1031				6.500K			
FT-1018	F1032	1200	191,1	18W	3.000K	2.160		11,46 €
	F1033				4.000K			
	F1034				6.500K			
FT-1022	F1035	1500	234,5	24W	3.000K	2.880	13,92 €	
	F1036				4.000K			
	F1037				6.500K			
FT-1000	F1013	Sustituto cebador						0,50 €

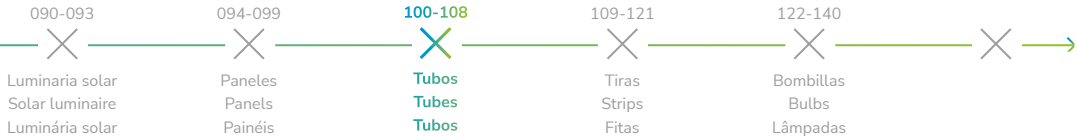

## T5 LED TUBES

Las lámparas de tubo T5 LED de Filux son de aspecto elegante. Disponemos de diferentes modelos con distintas temperaturas de color, entre los que destacamos el blanco neutro, el blanco frío o el blanco cálido. Estas lámparas de tubo LED se instalan directamente en el accesorio existente para T5.

Filux T5 LED tube lamps have an elegant looking. Different models with different color temperatures, among which we highlight neutral white, cold white or warm white. These LED tube lamps are installed directly into the existing T5 fixture.

Lâmpadas LED Filux T5 têm aparência elegante, temos diferentes modelos com temperaturas de cor diferentes, entre as quais destacamos branco neutro, branco frio ou branco quente. Estas lâmpadas de tubo LED são instaladas diretamente no equipamento existente para o T5.

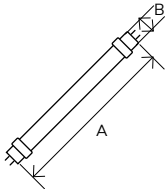

**5**  
YEAR  
WARRANTY

**50.000H**

**CRI**  
>80

**140°**

**PF**  
>0,95

**IP20**

**160LM/W**

**SMD**

**25 PCS**



Model	SKU	mm	kg	Power	C.Temp	Lumens	Input	€*
FT-5009	F5013	549	0,10	9W	3.000K	1.440	100-240V, 50Hz	30,07 €
	F5014				4.500K			
	F5015				6.000K			
FT-5012	F5016	849	0,14	12W	3.000K	1.920		
	F5017				4.500K			
	F5018				6.000K			
FT-5020	F5019	1.149	0,20	20W	3.000K	3.200		
	F5020				4.500K			
	F5021				6.000K			
FT-5025	F5022	1.449	0,26	25W	3.000K	4.000		
	F5023				4.500K			
	F5024				6.000K			

A B \*Ecoraee incluida | included | incluída \* IVA no incluido | VAT not included | IVA não incluído



## LED PRO TRI-PROOF LIGHT FITTING

Las pantallas Estanca LED de Filux F1140 y F1141 cuentan con driver Osram y chips Bridgelux. Su aplicación se extiende a cualquier espacio amplio, tanto interior como exterior y la instalación se realiza sin tener que modificar el cableado. Están fabricadas en materiales polímeros que aseguran su perdurabilidad en el tiempo. Cuentan con conexión 2 laterales (potencia máxima conectable: 300W).

Filux Waterproof LED tri-proof F1140 and F1141 have Osram driver and Bridgelux chips. Its application extends to any ample space, both interior and exterior ensure and the installation is done without having to modify the wiring. They are made of polymer materials that ensure their durability over time. 2 side connection (maximum power linkable: 300W).

As armaduras estanques LED Filux F1140 e F1141 têm driver Osram e chips Bridgelux. Sua aplicação é muito vast, podendo ser instalada em espaços interiores ou exteriores e a instalação é feita sem necessidade de modificar a cablagem. As armaduras são fabricadas em materiais poliméricos que garantem a sua durabilidade no tempo. Com 2 conexões laterais (potência máxima conectável: 300W).



5  
YEAR  
WARRANTY

50.000H

CRI  
>80

120°

PF  
>0,9



IP65

IK08

125LM/W



6 PCS



Model	SKU	mm			kg	Power	C.Temp	Lumens	Input	€*
		A	B	C	*Ecoraee incluída   included   incluída * IVA no incluído   VAT not included   IVA não incluído					
FT-1120	F1139	605	70	96	0,75	20W	5.000K	2.500	220-240V, 50/60Hz	57,61 €
FT-1140	F1140	1.210	71	71	0,8	40W		5.000		81,00 €
FT-1150	F1141	1.510			1,6	60W		7.500		106,31 €

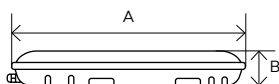

Conexión 2 laterales | 2 side connection | 2 ligações laterais

Max. potencia conectable 300W  
Max. power linkable 300W  
Potencia conectável max. 300W



090-093

Luminaria solar  
Solar luminaire  
Luminária solar

094-099

Paneles  
Panels  
Painéis

100-108

Tubos  
Tubes  
Tubos

109-121

Tiras  
Strips  
Fitas

122-140

Bombillas  
Bulbs  
Lâmpadas

## LED BATTEN IP65

Las pantallas Estancas LED de Filux consiguen que la instalación se realice sin tener que modificar el cableado. Su aplicación se extiende a cualquier espacio amplio, tanto interior como exterior. Todas las pantallas para tubos LED son estancas y cuentan con un diseño que facilita su montaje. Están fabricadas en materiales polímeros que aseguran su perdurabilidad en el tiempo.

Filux Waterproof LED tri-proof ensure that the installation is done without having to modify the wiring. Its application extends to any ample space, both interior and exterior. All screens for LED tubes are watertight and have a design that facilitates their assembly. They are made of polymer materials that ensure their durability over time.

As armaduras estancas LED Filux permitem que a sua instalação se faça sem modificar a cablagem. Sua aplicação é muito vast, podendo ser instalada em espaços interiores ou exteriores. As armaduras são fabricadas em materiais poliméricos que garantem a sua durabilidade no tempo.



**2**  
YEAR  
WARRANTY

**20.000H**

**CRI**  
>80

**110°**

**IP65**

**IK06**

**SMD**



Model	Sku	mm		kg	Power	C.Temp	Lumens	Input	SP	Units p/pack	€*
		A	B	C							
FT-1120	F1144	600			0,23	18W	1.620		>0,5	40	26,87 €
FT-1140	F1145	1.200	64	40	0,45	36W	3.240	AC230V	>0,9	20	42,41 €
FT-1150	F1146	1.500			0,60	45W	4.050				50,82 €

\*Ecorae incluida | included | incluida  
\* IVA no incluido | VAT not included | IVA não incluído

Fotometría | Photometrie | Fotometria

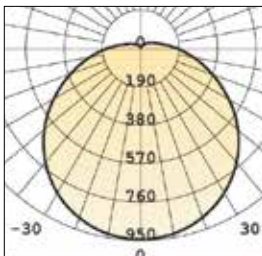

110°

Ángulo apertura  
Beam angle  
Ângulo de abertura

020-031



Campanas  
High bays  
Campânulas

032-046



Farolas  
Streetlights  
Viárias

047-055



Proyectores  
Floodlights  
Pojetores

056-075



Downlights  
Downlights  
Downlights

076-084



Sensores  
Sensors  
Sensores

085-089



Lum. emergencia  
Emergency lum.  
Lum. emergência

## WATERPROOF FITTINGS

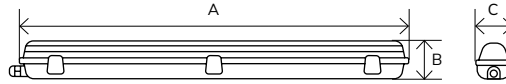

Grapas metálicas  
Metal staples  
Grampos de metal



IK08



10 PCS

Model	SKU	mm			kg	Descripción   Description   Descrição	€*
		A	B	C			
FT-5106	F5101	600	68	70	0,51	Pantalla Estanca IP65 600 mm para 1 tubo Waterproof Fitting IP65 600 mm for 1 tube Armadura Estanque IP65 de 600 mm para 1 tubo	20,37 €
FT-5112	F5102	1200			0,924	Pantalla Estanca IP65 1.200 mm para 1 tubo Waterproof Fitting IP65 1.200 mm for 1 tube Armadura Estanque IP65 de 1.200 mm para 1 tubo	32,76 €
FT-5115	F5103	1500			1,14	Pantalla Estanca IP65 1.500 mm para 1 tubo Waterproof Fitting IP65 1.500 mm for 1 tube Armadura Estanque IP65 de 1.500 mm para 1 tubo	40,02 €
FT-5206	F5201	600	103	103	0,662	Pantalla Estanca IP65 600 mm para 2 tubos Waterproof Fitting IP65 600 mm for 2 tubes Armadura Estanque IP65 de 600 mm para 2 tubos	24,65 €
FT-5212	F5202	1200			1,248	Pantalla Estanca IP65 1.200 mm para 2 tubos Waterproof Fitting IP65 1.200 mm for 2 tubes Armadura Estanque IP65 de 1.200 mm para 2 tubos	42,04 €
FT-5215	F5203	1500			1,546	Pantalla Estanca IP65 1.500 mm para 2 tubos Waterproof Fitting IP65 1.500 mm for 2 tubes Armadura Estanque IP65 de 1.500 mm para 2 tubos	52,00 €

\*Ecorae incluida | included | incluída

\* IVA no incluido | VAT not included | IVA não incluído

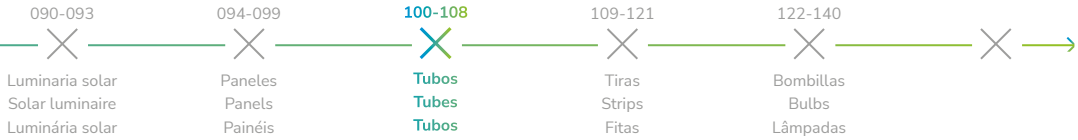

## LED SUPER SLIM IP20

Los plafones super slim LED de Filux son un sustituto perfecto para las pantallas de tubos fluorescentes tradicionales. Los plafones super Slim de Filux están hechos en aluminio + plástico y son ideales para oficinas, hoteles, concesionarios, centros comerciales, supermercados, almacenes, parkings.

The Filux LED super slim ceiling lamps are a perfect substitute for traditional fluorescent tube displays. The Filux super slim panels are made of aluminum + plastic and are ideal for offices, hotels, dealers, malls, supermarkets, warehouses, car parks.

Os painéis LED super slim da Filux são o substituto perfeito para armaduras de tubos fluorescentes tradicionais os painéis filux super slim são feito em alumínio + plástico são ideais para escritórios, hotéis, concessionários, centros comerciais, supermercados, armazéns, estacionamento.

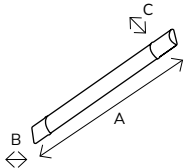
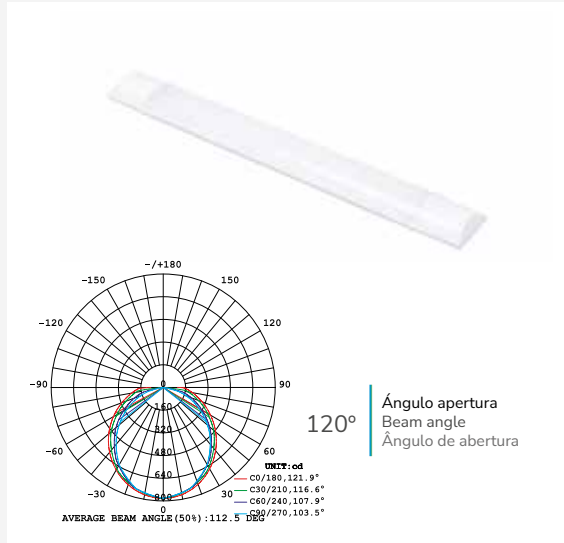

**2**  
YEAR  
WARRANTY

**25.000H**

**CRI**  
>80

**120°**

**PF**  
>0,9



IP20



IK06



1KV



SMD



40 PCS



Model	Sku	mm			kg	Power	C.Temp	Lumens	Input	€*
		A	B	C						

FT-2120	F2121	600	75	22	0,20	20W	4.000K	1.700-1.800	220-240V, 50Hz	19,21 €
	F2122						6.000K			
FT-2140	F2141	1.200	75	22	0,28	40W	4.000K	3.500-3.600	220-240V, 50Hz	31,97 €
	F2142						6.000K			
FT-2150	F2151	1.500	75	22	0,36	50W	4.000K	4.200-4.500	220-240V, 50Hz	39,59 €
	F2152						6.000K			

\*Ecoraee incluida | included | incluída  
\* IVA no incluido | VAT not included | IVA não incluído

020-031	032-046	047-055	056-075	076-084	085-089
Campanas High bays Campânulas	Farolas Streetlights Viárias	Proyectores Floodlights Pojetores	Downlights Downlights Downlights	Sensores Sensors Sensores	Lum. emergencia Emergency lum. Lum. emergência

## T5 BATTEN WITH SWITCH

La barra lineal T5 de Filux con interruptor incorporado puede conectarse una a una y un interruptor puede controlar hasta 10 lámparas. Diferentes modelos pueden conectar hasta 8 lámparas. La corriente máxima permitida de lámparas es 0,8A.

Filux T5 linear bar with built-in switch can be connected one by one and one switch can control up to 10 lamps. Different models can connect up to 8 lamps. The maximum allowed current of lamps is 0.8A.

A barra linear Filux T5 com interruptor embutido pode ser conectada uma a uma e uma chave pode controlar até 10 lâmpadas. Diferentes modelos podem conectar até 8 lâmpadas. A corrente máxima permitida das lâmpadas é 0,8A.



  
>15.000H

**PF**  
0,5

  
110°

  
IP20



Model	SKU	mm			kg	Power	C.Temp	Lumens	Input	Units p/pack	€*
		A	B	C							
FT-1104	F1147	272	22	36	0,20	4W	4.000K	320	220-240V, 50/60Hz	40	11,97 €
	6500K										
FT-1108	F1149	572	22	36	0,28	8W	4.000K	640	220-240V, 50/60Hz	40	14,13 €
	6.500K										
FT-1116	F1151	1.172	22	36	0,36	16W	4.000K	1.280	220-240V, 50/60Hz	30	19,63 €
	6.500K										

\*Ecoraee incluída | included | incluída  
\* IVA no incluído | VAT not included | IVA não incluído

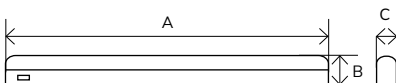

Conexión 2 laterales | 2 side connection | 2 ligações laterais  
Max. potencia conectable 175W | Max. power linkable 175W | Potencia conectável max. 175W



109-121



Tiras  
Strips  
Fitas





## LED STRIPS 230V

Las tiras LED profesionales 230v Filux, con conexión directa a AC, 50 metros lineales, conexión seguida con un solo punto de alimentación, ofrecen calidad de iluminación con un bajo consumo de energía. Se permite crear espacios entornos, personalizar los espacios diferenciando el estilo.

The 230v Filux professional LED strips, with direct connection to AC, 50 linear meters, connection followed by a single power point, offer lighting quality with low power consumption. It is allowed to create special environments, customize the spaces differentiating the style.

A fita de LED profissional Filux 230v, ligação direta a AC, 50 metros lineares seguidas por um único ponto de potência. O rolo de fita de LED de 50m oferece qualidade de iluminação com baixo consumo de energia. Permite criar ambientes especiais, personalizar os espaços diferenciando o estilo.



**3**  
YEAR  
WARRANTY

**CRI**  
>80

**120°**

**A+**  
LABEL

**100LM/W**

**PF**  
>0,93

**IP65**

**50 mts**



Model	SKU	mm	Power	C.Temp	Input	Led Quantity	€*
-------	-----	----	-------	--------	-------	--------------	----

Cantidad de led  
Quantidade de led

\*\*Ecorae incluida | included | incluída \* IVA no incluido | VAT not included | IVA não incluído

\* €/ Metro | \* €/ Meter | \* €/ Metro

FT-2815	F2858	40.000x12	17W/m	2.700K	220-240V, 50/60Hz	120LED/m	25,88 €
	F2859			4.000K			
	F2860			6.500K			
	F2874	50.000x12	12W/m	RGB		72LED/m	26,30 €

### Fotometría | Photometrie | Fotometria

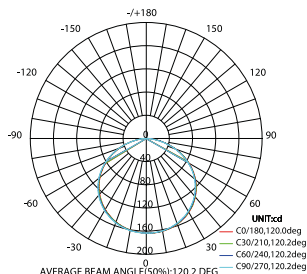

120°  
 Ángulo apertura  
 Beam angle  
 Ângulo de abertura

090-093

Luminaria solar  
Solar luminaire  
Luminária solar

094-099

Paneles  
Panels  
Painéis

100-108

Tubos  
Tubes  
Tubos

109-121

Tiras  
Strips  
Fitas

122-140

Bombillas  
Bulbs  
Lâmpadas

## 230V LED STRIPS ACCESSORIES



Model	SKU	Descripción   Description   Descrição	€*
*Ecoraee incluída   included   incluída * IVA no incluído   VAT not included   IVA não incluído			
FT-2830	F2864	Kit conector flexible atornillado IP 65 screwed flexible connector kit Kit de conector flexível aparafusado	5,07 €
	F2875	Controlador tira AC RGB Controller strip RGB AC Faixa controladora RGB AC	115,87 €
	F2876	Kit conector RGB AC para F2874 RGB connector kit for F2874 Kit de conector RGB para F2874	6,40 €



## LED STRIPS PRO 24V

La bobina de 10m de tira LED Filux ofrece una iluminación de calidad con muy bajo consumo energético. Permite crear ambientes especiales, personalizar espacios y darles un toque diferenciador.

The Filux 10m LED Strip coil offers quality lighting with very low power consumption. It allows to create special environments, to personalize spaces and to give them a differentiating style.

O rolo de 10m da fita de LED Filux oferece uma iluminação e qualidade com baixo consumo de energia. Permite criar ambientes especiais, personalizar espaços e dar-lhes um toque diferenciador.



**5**  
YEAR  
WARRANTY

**CRI**  
>80

**120°**

**100LM/W**

**10 mts**



Model	Sku	mm	Power	Max. M connection M. de conexión máxima	C.Temp	Input	IP	Led Quantity	€*
				*Ecorae incluida   included   incluída * IVA no incluido   VAT not included   IVA não incluído					
				*€/Rollo   *€/Roll   *€/Rolo					
FT-2042	F2840	10.000 x8	4,8W/m	30 meter	2.700K	DC24V	IP20	60 LED/m	117,33 €
	F2841				4.000K				
	F2842				6.500K				
FT-2122	F2843	10.000 x10	12W/m	15 meter	2.700K			120 LED/m	159,21 €
	F2844				4.000K				
	F2845				6.500K				
FT-2192	F2846	10.000 x10	19,2W/m	10 meter	2.700K			171,16 €	
	F2847				4.000K				
	F2848				6.500K				
FT-2046	F2849	10.000 x9	4,8W/m	30 meter	2.700K			60 LED/m	166,65 €
	F2850				4.000K				
	F2851				6.500K				
FT-2126	F2852	10.000 x11	12W/m	15 meter	2.700K	120 LED/m	207,65 €		
	F2853				4.000K				
	F2854				6.500K				
FT-2196	F2855	10.000 x11	19,2W/m	10 meter	2.700K	223,63 €			
	F2856				4.000K				
	F2857				6.500K				





## LED STRIPS 24V

La bobina de 10m de tira LED Filux ofrece una iluminación de calidad con muy bajo consumo energético. Permite crear ambientes especiales, personalizar espacios y darles un toque diferenciador.

The Filux 10m LED Strip coil offers quality lighting with very low power consumption. It allows to create special environments, to personalize spaces and to give them a differentiating style.

O rolo de 10m da fita de LED Filux oferece uma iluminação e qualidade com baixo consumo de energia. Permite criar ambientes especiais, personalizar espaços e dar-lhes um toque diferenciador.



**2**  
YEAR  
WARRANTY

**CRI**  
>80

**120°**

**90LM/W**

**10 mts**



Model	SKU	mm	Power	C.Temp	Input	IP	Led Quantity	€*
							Cantidad de led Quantidade de led	
*Ecoraee incluida   included   incluída * IVA no incluido   VAT not included   IVA não incluído								
* €/Rollo   * €/Roll   * €/Rolo								
FT-2820	F2821	10.000x8	12W/m	3.000K	DC24V	IP20	60 LED/m	37,77 €
	F2822			4.500K				
	F2823			6.000K				

### Fotometría | Photometrie | Fotometria

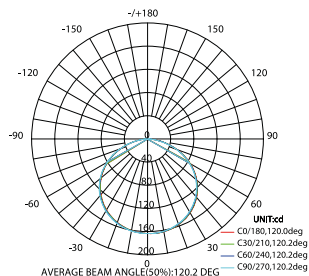

120°

Ángulo apertura  
Beam angle  
Ângulo de abertura

020-031

Campanas  
High bays  
Campânulas

032-046

Farolas  
Streetlights  
Viárias

047-055

Proyectores  
Floodlights  
Pojetores

056-075

Downlights  
Downlights  
Downlights

076-084

Sensores  
Sensors  
Sensores

085-089

Lum. emergencia  
Emergency lum.  
Lum. emergência

## 24V LED STRIPS ACCESSORIES

### Power supply

Fuente alimentación  
Power supply  
Fonte de alimentação

F2869

F2871

**5**  
YEAR  
WARRANTY

Model	Sku	Power	Input V	Output V	Output Current	Efficiency	mm	IP	€*
-------	-----	-------	---------	----------	----------------	------------	----	----	----

\*Ecorae incluida | included | incluída \* IVA no incluido | VAT not included | IVA não incluído

FT-2804	F2865	36W	AC100-240V, 50/60Hz	24V±5%	1.5A	≥85%	135x35x24	20	14,21 €
	F2866	60W			2.5A		170x35x24		18,13 €
	F2867	100W			4.17A		145x49x29		25,60 €
	F2868	150W			6.25A		195x49x29		34,94 €
	F2869	200W			8.3A		195x49x29		38,01 €
	F2870	60W	AC100-277V, 50/60Hz		2.5A		67	203x35x25	27,97 €
	F2871	100W			4.17A			187x69x19	43,62 €
	F2872	150W			6.25A			187x69x19	54,02 €
	F2873	200W			8.33A			227x80x39	73,81 €

### Controller

Controlador  
Controller  
Controlador**5**  
YEAR  
WARRANTY

F2878



F2879



F2880



F2881



F2882

Model	Sku	Power	Input V	Output V	Output Current	mm	€*
-------	-----	-------	---------	----------	----------------	----	----

\*Ecorae incluida | included | incluída \* IVA no incluido | VAT not included | IVA não incluído

FT-2801	F2878	180-360W	12-24VDC	5x12-24VDC	5CH,3A/CH	114x38x20	64,59 €
	F2879	60-120W		12-24VDC	Max. 5A	64X23,5X8,5	20,51 €
	F2880	240-480W	12-48VDC	12-48VDC	8A@12/24V,4A36/48V	52x52x26	36,93 €
	F2881		12-24VDC	12-24VDC	1CH,20A	107x75x24,5	46,68 €
	F2882				1CH,20A Max.	107x75x38	47,72 €



\*Ecoraee incluída | included | incluída  
 \* IVA no incluído | VAT not included | IVA não incluído

## Power repeater

**5**  
YEAR  
WARRANTY



IP20



-30° | +55°

Repetidor potencia 8A  
 Power Repeater 8A  
 Repetidor energia 8A

**192W**

<b>FT-2801 F2883</b>	Input voltage	5-36VDC
	Input current	8.5A
	Input signal	PWM
	Output voltage	5-36VDC
	Output current	8A
	Output power	40-288W
	Output type	Constant voltage

22,69 \*€

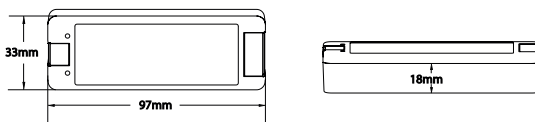

## ON/OFF sensor + dimmer

**5**  
YEAR  
WARRANTY



-30° | +55°

Sensor ON/OFF + dimmer  
 ON / OFF sensor + dimmer  
 Sensor ON / OFF + dimmer

**75W**

<b>FT-2801 F2884</b>	Input voltage	12-24VDC
	Output voltage	12-24VDC
	Output power	Max. 36W@12V Max. 72W@24V
	Output type	Constant voltage

14,35 \*€

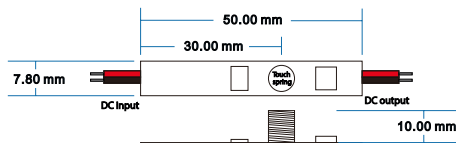
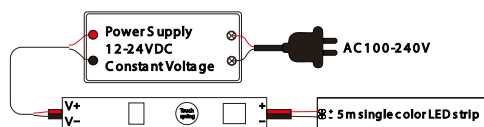

020-031

Campanas  
High bays  
Campânulas

032-046

Farolas  
Streetlights  
Viárias

047-055

Proyectores  
Floodlights  
Pojetores

056-075

Downlights  
Downlights  
Downlights

076-084

Sensores  
Sensors  
Sensores

085-089

Lum. emergencia  
Emergency lum.  
Lum. emergência

## 24V LED STRIPS ACCESSORIES

### Door sensor

Sensor de puerta  
Door sensor  
Sensor da porta

96W

**5**  
YEAR  
WARRANTY

**-30° | +55°**

FT-2801 F2885	Input voltage	12-24VDC
	Output voltage	12-24VDC
	Output power	Max. 48W@12V Max. 96W@24V
	Detect. distance	<10 cm
	Detect. angle	15-30

14,35 \*€

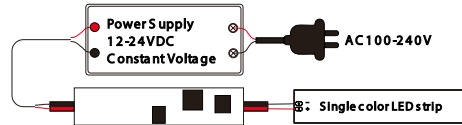
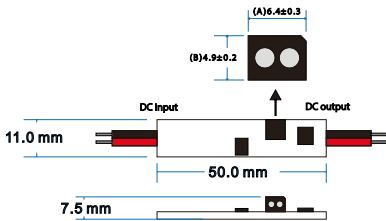

### Motion sensor

Sensor de movimiento  
Motion sensor  
Sensor de movimento

72W

**5**  
YEAR  
WARRANTY

**-30° | +55°**

FT-2801 F2886	Input voltage	12-24VDC
	Output voltage	12-24VDC
	Output power	Max. 36W@12V Max. 72W@24V
	Detect. distance	<3m
	Detect. angle	120

16,43 \*€

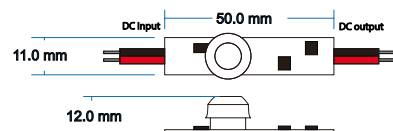
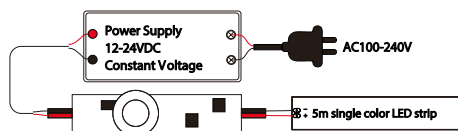



\*Ecoraee incluida | included | incluída  
 \* IVA no incluido | VAT not included | IVA não incluído

## Microwave sensor

Microwave sensor  
 Microwave sensor  
 Microwave sensor

**5**  
YEAR  
WARRANTY

**IP20**

**-30° | +55°**

<b>FT-2801 F2887</b>	Working voltage	9-24VDC
	Output signal	RF 2.4GHz
	HF system	10.525GHz
	Power consumption	< 0.5W(Standby) , <1W(Operation)
	Detection zone	Max.(DxH) 20 x 15m
	Detection sensitivity	10%/25%/50%/75%/100%
	Hold time	10S/30S/90S/3MIN/10MIN/20MIN/30MIN
	Daylight sensor	50lux/100lux/150lux/200lux/250lux/300lux/400lux
	Mounting height	15M MAX.
	Motion detection	0.5-3M/S
Detection angle	150° Wall   360° Ceiling	

58,92 \*€

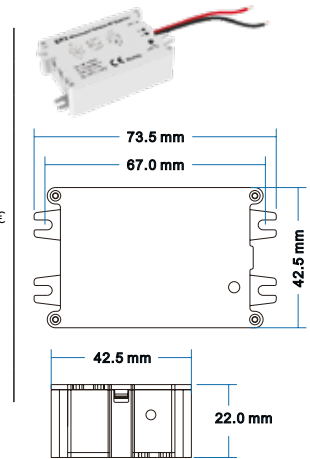

## RF single-color remote control

Mando monocolor RF 4 zonas  
 RF single-color remote control 4 zones  
 Controle remoto RF 1 cor 4 cores

**5**  
YEAR  
WARRANTY

**IP20**

**-30° | +55°**

<b>FT-2801 F2888</b>	Output signal	RF(2.4GHz)	42,22 *€
	Working voltage	3VDC(AAAx2)	
	Working current	<5mA	
	Standby current	<10µA	
	Standby time	1 year	
	Remote distance	30m	

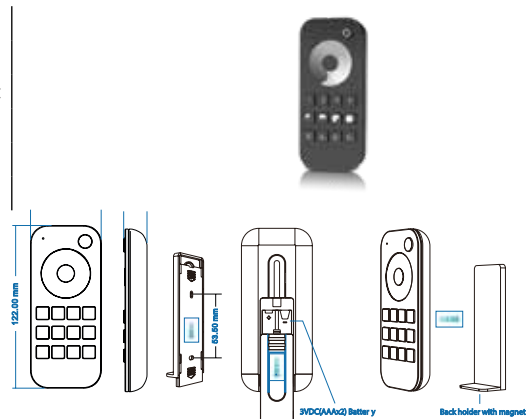

020-031

Campanas  
High bays  
Campânulas

032-046

Farolas  
Streetlights  
Viárias

047-055

Proyectores  
Floodlights  
Pojetores

056-075

Downlights  
Downlights  
Downlights

076-084

Sensores  
Sensors  
Sensores

085-089

Lum. emergencia  
Emergency lum.  
Lum. emergência

## 24V LED STRIPS ACCESSORIES

### RH single-color remote control

Mando monocolor RF 1 zona  
RF single-color remote control 1 zone  
Control remoto RF com uma cor 1 core

**5**  
YEAR  
WARRANTY



IP20



-30° | +55°

<b>FT-2801 F2889</b>	Output signal	RF(2.4GHz)	20,50 *€
	Working voltage	3VDC(AAAx2)	
	Working current	<5mA	
	Standby current	<2µA	
	Standby time	2 years	
	Remote distance	30m	

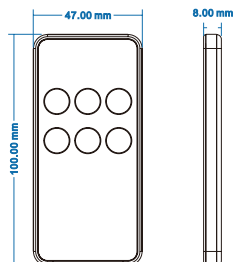

### RH wireless push button

Pulsador inalámbrico RF 1 zona  
RF wireless push button 1 zone  
Botão sem fio RF de 1 zona

**5**  
YEAR  
WARRANTY



IP20



-30° | +55°

<b>FT-2801 F2890</b>	Output signal	RF(2.4GHz)	28,79 *€
	Working voltage	3VDC(CR2032)	
	Working current	<5mA	
	Standby current	<2µA	
	Standby time	2 years	
	Remote distance	30m	

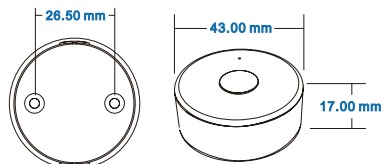



\*Ecoraee incluída | included | incluída  
 \* IVA no incluído | VAT not included | IVA não incluído

## RF wireless push button switch

Interruptor inalámbrico RF para pulsador  
 RF Wireless Push Button Switch  
 Interruptor de botão de pressão sem fio RF

**5**  
YEAR  
WARRANTY

**IP20**

**-30° | +55°**

<b>FT-2801 F2891</b>	Output signal	RF(2.4GHz)
	Working voltage	3VDC(CR2032)
	Working current	<5mA
	Standby current	<2µA
	Standby time	2 years
	Remote distance	30m

28,79 \*€

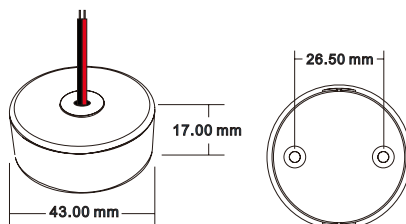

## Wireless on / off switch

Pastilla interruptor inalámbrico ON/OFF  
 Wireless ON / OFF switch  
 Interruptor ON/OFF sem fio

**5**  
YEAR  
WARRANTY

**IP20**

**-30° | +55°**

<b>FT-2801 F2892</b>	Input voltage	AC100-240V
	Output voltage	AC100-240V
	Output current	Max 3A
	Output power	300-720W
	Input signal	RF 2.4GHz+Push switch
	RF Cont. distance	30m

47,16 \*€

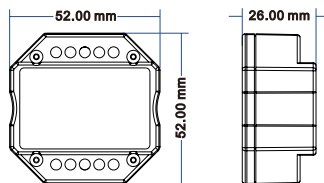

020-031

Campanas  
High bays  
Campânulas

032-046

Farolas  
Streetlights  
Viárias

047-055

Proyectores  
Floodlights  
Pojetores

056-075

Downlights  
Downlights  
Downlights

076-084

Sensores  
Sensors  
Sensores

085-089

Lum. emergencia  
Emergency lum.  
Lum. emergência

## LED STRIPS ACCESSORIES

### AC triac wireless regulator pickup

Pastilla regulador inalámbrico AC TRIAC  
AC TRIAC Wireless Regulator Pickup  
Pastilha regulador TRIAC AC sem fio**5**  
YEAR  
WARRANTY

<b>FT-2801 F2893</b>	Input voltage	AC100-240V	46,11 *€
	Output voltage	AC100-240V	
	Output current	Max 1,5A	
	Output power	150-360W	
	Input signal	RF 2.4GHz+Push Dim	
	RF Cont. distance	30m	

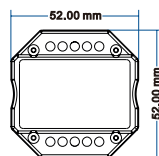

### Central wifi

Central WIFI  
Central WIFI  
Central Wi-Fi**5**  
YEAR  
WARRANTY

<b>FT-2801 F2894</b>	Operating V & Current:	DC5-24V,300mA	83,14 *€
	Wireless standard:	802.11 b/g/n	
	Frequency range	2.412GHz~2.484GHz	
	Remote Distance:	30m	
	Standby time	2 years	
	Remote distance	30m	

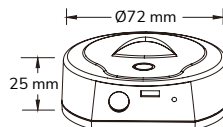



090-093

Luminaria solar  
Solar luminaire  
Luminária solar

094-099

Paneles  
Panels  
Painéis

100-108

Tubos  
Tubes  
Tubos

109-121

Tiras  
Strips  
Fitas

122-140

Bombillas  
Bulbs  
Lâmpadas

## ALUMINIUM PROFILES

\*Ecoraee incluída | included | incluída \* IVA no incluido |  
VAT not included | IVA não incluídoFT-2802  
F2814Perfil ángulo opaco 2 Mts  
Opaque angle profile  
2 Mts  
Perfil Ângulo opaco 2 Mts

24,05 \*€

FT-2802  
F2815Perfil para empotrar 2 Mts  
Recessed aluminium profile 2 Mts  
Perfil encastrar 2 Mt

23,26 \*€

FT-2802  
F2816Perfil para superficie 2 Mts  
Surface profile 2 Mts  
Perfil superfície 2 Mts

20,19 \*€





122-140



Bombillas

Bulbs

Lâmpadas





## GU10 LED PRO CRISTAL BULB 9W

La bombilla LED PRO Cristal de Filux con conexión GU10 nos proporciona un agradable tono de luz. Supone una alternativa muy buena con amplias posibilidades de decoración y gran ahorro energético. Su instalación es muy sencilla, basta con retirar el halógeno tradicional y situar la nueva lámpara con casquillo GU10 con conexión directa a la red.

Filux LED PRO Cristal bulb with GU10 connection provides a pleasant light tone. That means a very good alternative with ample possibilities of decoration and great energy saving. Its installation is very simple, just remove the traditional halogen and place the new lamp with GU10 bushing with direct connection to the network.

A lâmpada LED PRO Cristal Filux com ligação GU10 fornece um tom de luz bastante agradável. É uma alternativa com amplias possibilidades de decoração e grande poupança energética. Sua instalação é muito simples, basta remover a lâmpada de halogéneo tradicional e colocar a nova lâmpada GU10 com ligação direta à rede.

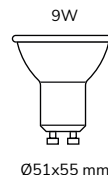

Model	SKU	Power	C.Temp	Lumens	Input	CRI	€*
*Ecoraee incluída   included   incluída * IVA no incluído   VAT not included   IVA não incluído							
FT-1505	F1519	9W	2.700K	750	230V	80	10,35 €
	F1520		4.000K				
	F1521		2.700K	575		97	10,78 €
	F1522		4.000K				



## GU10 LED PRO CRISTAL BULB 8W

La bombilla LED PRO Cristal de Filux con conexión GU10 nos proporciona un agradable tono de luz. Supone una alternativa muy buena con amplias posibilidades de decoración y gran ahorro energético. Su instalación es muy sencilla, basta con retirar el halógeno tradicional y situar la nueva lámpara con casquillo GU10 con conexión directa a la red.

Filux LED PRO Cristal bulb with GU10 connection provides a pleasant light tone. That means a very good alternative with ample possibilities of decoration and great energy saving. Its installation is very simple, just remove the traditional halogen and place the new lamp with GU10 bushing with direct connection to the network.

A lâmpada LED PRO Cristal Filux com ligação GU10 fornece um tom de luz bastante agradável. É uma alternativa com amplias possibilidades de decoração e grande poupança energética. Sua instalação é muito simples, basta remover a lâmpada de halógeno tradicional e colocar a nova lâmpada GU10 com ligação direta à rede.

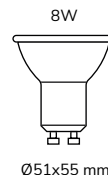

**5**  
YEAR  
WARRANTY

**25.000H**

**CRI**  
>90

**60°**

**SMD**

**IP20**

**GU10**

**PF**  
0,7

**TRIAC**  
DIMMABLE

**10 PCS**



Model	Sku	Power	C.Temp	Lumens	Input	€*
*Ecoraee incluída   included   incluída * IVA no incluído   VAT not included   IVA não incluído						
FT-1505	F1516	8W	2.700K	575	230V	8,39 €
	F1517		4.000K			
	F1518		6.500K			



## GU10 LED BULB 6,5W. Samsung chip

Esta bombilla LED de Filux con conexión GU10 nos proporciona un agradable tono de luz. Supone una alternativa muy buena con amplias posibilidades de decoración y gran ahorro energético. Su instalación es muy sencilla, basta con retirar el halógeno tradicional y situar la nueva lámpara con casquillo GU10 con conexión directa a la red.

This Filux LED bulb with GU10 connection provides a pleasant light tone. That means a very good alternative with ample possibilities of decoration and great energy saving. Its installation is very simple, just remove the traditional halogen and place the new lamp with GU10 bushing with direct connection to the network.

Esta lâmpada LED Filux com ligação GU10 fornece um tom de luz bastante agradável. É uma alternativa com amplias possibilidades de decoração e grande poupança energética. Sua instalação é muito simples, basta remover a lâmpada de halógeno tradicional e colocar a nova lâmpada GU10 com ligação direta à rede.



**2**  
YEAR  
WARRANTY

**15.000H**

**CRI**  
**>80**

**110°**



IP20



GU10



100 PCS



Model	SKU	Power	C.Temp	Lumens	Input	€*
FT-1507	F1513	6,5W	3.000K	560	220-240V, 50Hz	3,89 €
	F1514		4.000K			
	F1515		6.500K			

\*Ecoraee incluida | included | incluída \* IVA no incluído | VAT not included | IVA não incluído

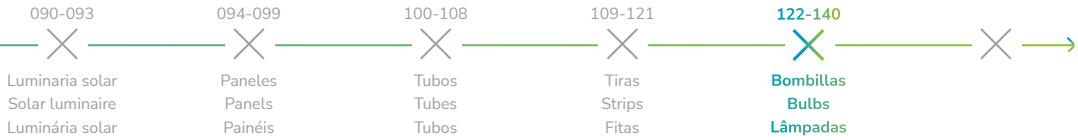

## GU10 LED DICHOIC BULB 4W

La bombilla Dicroica LED de Filux con conexión GU10 nos proporciona un agradable tono de luz. Su instalación es muy sencilla, basta con retirar el halógeno tradicional y situar la nueva lámpara con casquillo GU10 con conexión directa a la red.

Filux LED dichroic bulb with GU10 connection provides a pleasant light tone. Its installation is very simple, just remove the traditional halogen and place the new lamp with GU10 bushing with direct connection to the network.

A lâmpada LED dicroica Filux com ligação GU10 fornece um tom de luz bastante agradável. Sua instalação é muito simples, basta remover a lâmpada de halogéneo tradicional e colocar a nova lâmpada GU10 com ligação direta à rede.

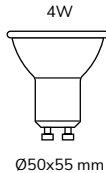

Model	Sku	Power	C.Temp	Lumens	Input	€*
*Ecorae incluida   included   incluída * IVA no incluido   VAT not included   IVA não incluído						
FT-1504	F1505	4W	3.000K	250	220-240V, 50Hz	2,98 €
	F1506		4.000K			
	F1504		6.500K			

## GU5.3 LED DICHOIC BULB 6W

Lámpara LED FT1306 con conexión GU5.3 perfecta para apliques de techo, así como en iluminación de escaparates. De instalación muy sencilla, basta con retirar el halógeno tradicional y situar la nueva lámpara con casquillo GU5.3.

FT-1306 LED lamp with GU5.3 connection is perfect for ceiling applications as well as in shop window lighting. With a very simple installation, ust remove the traditional halogen and place the new lamp with GU5.3 bushing.

Lâmpada LED GU5.3 FT-1306 12V, ideal para aplicações em tetos faldos. Instalação muito simples e rápida, basta remover a lâmpada de halogéneo tradicional e coloque a nova lâmpada com ligador GU5.3.

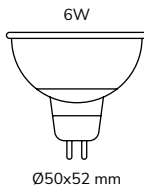

Model	Sku	Power	C.Temp	Lumens	Input	€*
*Ecorae incluida   included   incluída * IVA no incluido   VAT not included   IVA não incluído						
FT-1306	F1301	6W	3.000K	470	AC/DC 12V	3,88 €
	F1302		4.000K			
	F1303		6.000K			

020-031

Campanas  
High bays  
Campânulas

032-046

Farolas  
Streetlights  
Viárias

047-055

Proyectors  
Floodlights  
Pojetores

056-075

Downlights  
Downlights  
Downlights

076-084

Sensores  
Sensors  
Sensores

085-089

Lum. emergencia  
Emergency lum.  
Lum. emergência

## A60 LED BULB

Bombilla LED A60 E27 de Filux con una alta eficiencia energética y una vida útil de larga duración. Es ideal para sustituir a las antiguas bombillas de incandescencia con casquillo E27, consiguiendo un ahorro energético del 80%. Ofrece un encendido instantáneo y es respetuosa con el medio ambiente.

Filux LED bulb A60 E27 with high energy efficiency and long life. It's ideal for replacing old incandescent bulbs with a E27 socket, achieving an 80% energy saving. It offers an instant start and is respectful with the environment.

As lâmpadas LED Filux A60 E27 de alta eficiência energética e vida longa. São ideais para substituir as lâmpadas incandescentes E27, permitindo uma economia de energia de 80%. Dispõem de acendimento instantânea e respeitam o meio ambiente.



Ø60x120 mm



**2**  
YEAR  
WARRANTY

**15,000H**

**220°**

**CRI**  
>80



IP20



E27



SMD



100 PCS



Model	SKU	Power	C.Temp	Lumens	Input	Chip	€*
-------	-----	-------	--------	--------	-------	------	----

\*Ecoraee incluída | included | incluída \* IVA no incluído | VAT not included | IVA não incluído

FT-1605	F1601	5W	3.000K	470	220-240V, 50Hz	EPISTAR LED	3,01 €
	F1602		4.000K				
	F1603		6.500K				
FT-1610	F1633	8W	3.000K	840		OSRAM LED	3,49 €
	F1634		4.000K				
	F1635		6.500K				
FT-1612	F1636	11W	3.000K	1.100		SAMSUNG LED	4,22 €
	F1637		4.000K				
	F1638		6.500K				
FT-1616	F1639	13,7W	3.000K	1.600			5,40 €
	F1640		4.000K				
	F1641		6.500K				



090-093

094-099

100-108

109-121

122-140

Luminaria solar  
Solar luminaire  
Luminária solar

Paneles  
Panels  
Painéis

Tubos  
Tubes  
Tubos

Tiras  
Strips  
Fitas

Bombillas  
Bulbs  
Lâmpadas

## A55 LED BULB

Bombilla LED A55 E27 de Filux con una alta eficiencia energética y una vida útil de larga duración. Es ideal para sustituir a las antiguas bombillas de incandescencia con casquillo E27, consiguiendo un ahorro energético del 80%. Ofrece un encendido instantáneo y es respetuosa con el medio ambiente.

Filux LED bulb A55 E27 with high energy efficiency and long life. It's ideal for replacing old incandescent bulbs with a E27 socket, achieving an 80% energy saving. It offers an instant start and is respectful with the environment.

Lâmpada LED A55 E27 Filux, de alta eficiência energética e vida útil longa. É ideal para a substituição das lâmpadas antigas de incandescência, permitindo uma poupança de energia até 80%. É de acendimento instantâneo e respeita o meio ambiente.



Ø55x98 mm

Model	Sku	Power	C.Temp	Lumens	Input	€*
FT-1505	F1510	5W	6.500K	400	220-240V, 50Hz	2,84 €
	F1511		3.000K			
	F1512		4.000K			

\*Ecorae incluida | included | incluída  
\* IVA no incluido | VAT not included | IVA não incluído

2  
YEAR  
WARRANTY



200°



25.000H



E27

CRI  
>80



SMD



IP20



100 PCS

## R90 LED BULB 15W

La Bombilla LED FT-3515 sustituye a las lámparas incandescentes tradicionales de hasta 100W con casquillo E27. Su carcasa translúcida tiene una forma característica. Proporcionan un agradable tono de luz además de un ahorro en el consumo superior al 80%.

The FT-3515 LED Bulb replaces traditional incandescent lamps up to 100W with E27 lamp holder. It's translucent shell has a characteristic shape. They provide a pleasant tone of light in addition to a saving in consumption of more than 80%.

A lâmpada LED FT-3515 substitui as lâmpadas incandescentes tradicionais até R90 E27 de 100W. O seu corpo é translúcido têm uma forma característica. Fornecem um tom de luz muito agradável de luz, além permitir poupanças de energia até 80%.

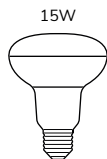

Ø90x116 mm

Model	Sku	Power	C.Temp	Lumens	Input	€*
FT-3515	F1623	15W	3.000K	1.300	175-250V, 50HZ	9,06 €
	F1624		4.000K			
	F1625		6.000K			

\*Ecorae incluida | included | incluída  
\* IVA no incluido | VAT not included | IVA não incluído

2  
YEAR  
WARRANTY



120°



25.000H



E27

CRI  
>80



SMD



IP20



50 PCS



## G45 LED BULB 7,5W. Osram LED

Bombilla Esférica LED G45 E27 con LEDs Osram de Filux ideales para uso doméstico. Perfectas para todo tipo de aplicaciones, gracias a los múltiples tamaños y prestaciones. Obtendrás mayor eficiencia y ahorro en tu factura de la electricidad, al mismo tiempo que disfrutarás de iluminación de mayor calidad.

Filux LED Light Bulb G45 E27 with Osram LEDs ideal for home use. Perfect for all types of applications, thanks to the multiple sizes and features. You will get more efficiency and savings in your electricity bill, while enjoying better lighting.

Lâmpada esférica LED G45 E27 Filux com Chip Osram, ideal para uso doméstico. Indicada para todos os tipos de aplicação, graças aos vários tamanhos e potências. Permite maior otimização na conta de electricidade enquanto beneficia de uma iluminação de melhor qualidade.

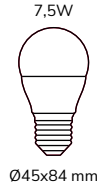

**2**  
YEAR  
WARRANTY

**15.000H**

**CRI**  
>80

**220°**

**SMD**

**IP20**

**E27**



**100 PCS**



Model	Sku	Power	C.Temp	Lumens	Input	Chip	€*
*Ecoraee incluída   included   incluída * IVA no incluído   VAT not included   IVA não incluído							
FT-1807	F1807	7,5W	3.000K	860	220-240V, 50Hz	OSRAM LED	4,82 €
	F1808		4.000K				
	F1809		6.500K				

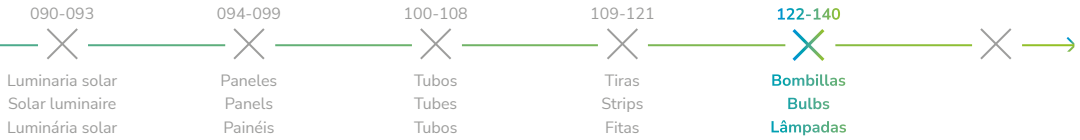

## P45 LED BULB

Bombilla Esférica LED P45 E14 de Filux ideales para uso doméstico. Perfectas para todo tipo de aplicaciones, gracias a los múltiples tamaños y prestaciones. Obtendrás mayor eficiencia y ahorro en tu factura de la electricidad, al mismo tiempo que disfrutarás de iluminación de mayor calidad.

Filux LED Light Bulb P45 E14 ideal for home use. Perfect for all types of applications, thanks to the multiple sizes and features. You will get more efficiency and savings in your electricity bill, while enjoying better lighting.

As lâmpadas esféricas LED P45 E14 Filux, são ideais para o uso doméstico perfeias para todos os tipos de aplicações, graças aos vários tamanhos e características. Permite-lhe uma maior eficiência poupança de energia, além de lhe permitir beneficiar melhor qualidade de iluminação.



4W/7W

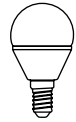

Ø45x78 mm

**2**  
YEAR  
WARRANTY

**25.000H**

**CRI**  
>80

**200°**

**IP20**

**E14**

**100 PCS**

**SMD**



Model	SKU	Power	C.Temp	Lumens	Input	€*
-------	-----	-------	--------	--------	-------	----

\*Ecorae incluida | included | incluída \* IVA no incluido | VAT not included | IVA não incluído

FT-1904	F1905	4W	3.000K	300	220-240V, 50Hz	2,57 €
	F1906		4.000K			
	F1904		6.500K			
FT-1907	F1908	7W	3.000K	560		3,30 €
	F1909		4.000K			3,30 €
	F1907		6.500K			

020-031

Campanas  
High bays  
Campânulas

032-046

Farolas  
Streetlights  
Viárias

047-055

Proyectores  
Floodlights  
Pojetores

056-075

Downlights  
Downlights  
Downlights

076-084

Sensores  
Sensors  
Sensores

085-089

Lum. emergencia  
Emergency lum.  
Lum. emergência

## C37 LED CANDLE BULB

Bombilla LED E14 de Filux de 4W y 7W de potencia, con una alta eficiencia energética y una vida útil de larga duración. Es ideal para sustituir a las antiguas bombillas de incandescencia con casquillo E14 de hasta 35W, consiguiendo un ahorro energético del 80%. Ofrece un encendido instantáneo y es respetuosa con el medio ambiente.

Filux LED bulb E14 of 4W and 7W of power, with high energy efficiency and long life duration. It's ideal to replace the old incandescence bulbs with E14 sockets of up to 35W, achieving an energy saving of 80%. It offers an instant start and is respectful with the environment.

Lâmpada vela LED E14 Filux com potências de 4W e 7W, com elevada eficiência energética e vida longa. São ideais para substituir as lâmpadas incandescentes de vela antigas com E14 de 35W, permite-nos uma poupança de energia de 80%. Têm acendimento instantâneo e respeita o meio ambiente.



4-7W

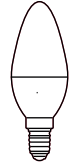

Ø60x110 mm

2  
YEAR  
WARRANTY

25.000H

CRI

&gt;80



200°



SMD



IP20



E14

PF

&gt;0,5



100 PCS



Model	SKU	Power	C.Temp	Lumens	Input	€*
-------	-----	-------	--------	--------	-------	----

\*Ecoraee incluída | included | incluída \* IVA no incluido | VAT not included | IVA não incluído

FT-1704	F1705	4W	3.000K	300	220-240V, 50Hz	2,55 €
	F1706		4.000K			
	F1704		6.500K			
FT-1707	F1708	7W	3.000K	560		3,53 €
	F1709		4.000K			
	F1707		6.500K			

090-093

Luminaria solar  
Solar luminaire  
Luminária solar

094-099

Paneles  
Panels  
Painéis

100-108

Tubos  
Tubes  
Tubos

109-121

Tiras  
Strips  
Fitas

122-140

Bombillas  
Bulbs  
Lâmpadas

## G120 LED BULB 20W

La bombilla FT-1420 combina la eficiencia de la tecnología LED con un diseño muy característico el cual brinda una iluminación uniforme en los espacios en los cuales se utiliza. De encendido instantáneo y sin parpadeos, aportando un gran ahorro en el consumo de energía eléctrica.

The FT-1420 bulb combines the efficiency of LED technology with a very characteristic design which provides uniform illumination in the spaces in which it is used. Instantaneous and flicker-free ignition, providing great savings in electricity consumption.

A lâmpada de led FT-1420 combina a eficiência da tecnologia LED com um design muito característico que proporciona uma iluminação uniforme nos espaços em que é utilizada. Acendimento instantâneo e sem cintilações, proporcionando grande poupança de energia.



6W

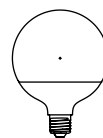

Ø120x161 mm

**2**  
YEAR  
WARRANTY  
25.000HCRI  
>80  
300°  
IP20  
E27  
20 PCS  
SMD

Model	SKU	Power	C.Temp	Lumens	Input	€*
FT-1420	F1626	20W	3.000K	1.700	175-250V, 50Hz	11,77 €
	F1627		4.000K			
	F1628		6.500K			

\*Ecoraee incluida | included | incluída \* IVA no incluido | VAT not included | IVA não incluído



## A60 LED FILAMENT BULB 6,7W

Las bombillas LED Filamento A60 con casquillo E27 de Filux son perfectas para todo tipo de aplicaciones. Sustitutas perfectas a las bombillas tradicionales. Las bombillas LED ofrecen un gran ahorro de energía, y mantenimiento.

The Filux filament LED bulbs A60 with socket E27 are perfect for all types of applications. They are a perfect replacement for traditional light bulbs. LED bulbs offer great energy savings, and maintenance.

As lâmpadas A60 de filamento LED E27 da Filux são a solução ideal para todos os tipos de aplicações. São a substituição ideal das lâmpadas incandescentes tradicionais. As lâmpadas LED permitem grandes poupanças de energia e manutenção.

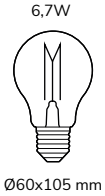

**2**  
YEAR  
WARRANTY

**15.000H**

**CRI**  
>80

**320°**

**FILAMENT**

**IP20**

**E27**

**PF**  
>0,5

**100 PCS**



Model	SKU	Power	C.Temp	Lumens	Input	€*
FT-1608	F1632	6,7W	2.700K	806	220-240V, 50Hz	5,52 €

\*Ecoraee incluida | included | incluída \* IVA no incluido | VAT not included | IVA não incluído

090-093

Luminaria solar  
Solar luminaire  
Luminária solar

094-099

Paneles  
Panels  
Painéis

100-108

Tubos  
Tubes  
Tubos

109-121

Tiras  
Strips  
Fitas

122-140

Bombillas  
Bulbs  
Lâmpadas

## C37 LED CANDLE FILAMENT BULB 4W

Las bombillas LED Filamento C37 con casquillo fino E14 de Filux son perfectas para todo tipo de aplicaciones. Sustitutas perfectas a las bombillas tradicionales. Las bombillas LED ofrecen un gran ahorro de energía, y mantenimiento.

The Filux filament LED bulbs C37 with fine socket E14 are perfect for all types of applications. They are a perfect replacement for traditional light bulbs. LED bulbs offer great energy savings, and maintenance.

As lâmpadas vela LED de filamento C37 casquilho E14 da Filux são ideais para todos os tipos de aplicações. São a substituição perfeita das lâmpadas incandescentes tradicionais. As lâmpadas led permitem grandes poupanças de energia e manutenção.



4W



Ø35x98 mm

**2**  
YEAR  
WARRANTY  
**15.000H****CRI**  
**>80**  
**320°**  
**FILAMENT**  
**IP20**  
**E14****PF**  
**>0,5**  
**100 PCS**

Model	SKU	Power	C.Temp	Lumens	Input	€*
FT-1007	F1010	4W	2.700K	470	220-240V, 50Hz	4,67 €

\*Ecoraee incluida | included | incluída \* IVA no incluido | VAT not included | IVA não incluído

020-031

Campanas  
High bays  
Campânulas

032-046

Farolas  
Streetlights  
Viárias

047-055

Proyectores  
Floodlights  
Pojetores

056-075

Downlights  
Downlights  
Downlights

076-084

Sensores  
Sensors  
Sensores

085-089

Lum. emergencia  
Emergency lum.  
Lum. emergência

## G9 LED BULB 2,5W

La bombilla LED FT-3725 nos permite sustituir a las bombillas halógenas tipo bi-pin con gran ahorro energético. Integrada con LEDs Epistar-SMD3014. No necesita transformador. Con tecnología LED de alta intensidad haciendo que una bombilla tan pequeña consiga una luz potente, clara y confortable.

The FT-3725 LED bulb allows us to replace bi-pin halogen bulbs with a great energy saving. Integrates Epistar-SMD3014 LEDs. It does not need a transformer. With high intensity LED technology making a small bulb get a powerful light, clear and cozy.

A lâmpada LED FT-3725 casquilho G9, permite substituir as lâmpadas tipo bi-pino de halógeno com grande poupança de energia. Usa chip Epistar-SMD3014. Não necessita de transformador, pois é de ligação directa à rede 230V. Através de tecnologia de LED é possível numa lâmpada com medidas reduzidas obter uma luz potente clara e confortável.



2,5W



16x48 mm

2  
YEAR  
WARRANTY

25.000H

CRI  
>80

270°

IP20

G9

PF  
>0,8

500 PCS



Model	SKU	Power	C.Temp	Lumens	Input	€*
FT-3725	F3701	2,5W	3.000K	200	220-240V, 50/60Hz	3,84 €
	F3702		4.000K			
	F3703		6.000K			

\*Ecoraee incluída | included | incluída \* IVA no incluído | VAT not included | IVA não incluído



090-093

Luminaria solar  
Solar luminaire  
Luminária solar

094-099

Paneles  
Panels  
Painéis

100-108

Tubos  
Tubes  
Tubos

109-121

Tiras  
Strips  
Fitas

122-140

Bombillas  
Bulbs  
Lâmpadas

## G4 LED BULB 1,5W

La bombilla G4 con un flujo luminoso de 120 lúmenes especialmente diseñada en reemplazo de las bombillas halógenas tanto lámparas decorativas como de techo. Con tecnología LED de alta intensidad haciendo que una bombilla tan pequeña consiga una luz potente, clara y comfortable.

The G4 bulb with a luminous flux level of 120 lumens, specially designed in replacemet of halogen bulbs in decorative and ceiling lights. Available in 3 light colors. With high intensity LED technology making a small bulb get a powerful light, clear and cozy.

A lâmpada G4 com um fluxo luminoso de 120 lumens especialmente desenvolvida para a substituição das lâmpadas de halogéneo decorativas. Disponíveis em temperaturas de cor. Através de tecnologia de LED é possível numa lâmpada com medidas reduzidas obter uma luz potente clara e confortável.



1,5W

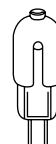

12x37 mm

**2**  
YEAR  
WARRANTY  
25.000HCRI  
>80  
270°  
IP20  
G4PF  
1  
500 PCS

Model	SKU	Power	C.Temp	Lumens	Input	€*
FT-3726	F3704	1,5W	3.000K	120	DC 12V	3,84 €
	F3705		4.000K			
	F3706		6.000K			

\*Ecoraee incluida | included | incluída \* IVA no incluido | VAT not included | IVA não incluído

020-031

Campanas  
High bays  
Campânulas

032-046

Farolas  
Streetlights  
Viárias

047-055

Proyectores  
Floodlights  
Pojetores

056-075

Downlights  
Downlights  
Downlights

076-084

Sensores  
Sensors  
Sensores

085-089

Lum. emergencia  
Emergency lum.  
Lum. emergência

## AR111 LED BULB 12W

La bombilla FT-2718 AR111 de Filux está especialmente pensada para la iluminación de espacios interiores de índole comercial como tiendas, restaurantes u hoteles, resulta especialmente práctica para destacar determinadas zonas o expositores de productos. Se trata de espacios donde son muy comunes los focos tipo kardan donde se ubican estas bombillas.

The FT-2718 AR111 Filux lightbulb is designed for the illumination of comercial indoors, like shops, restaurants or hotels. It's specially practical for highlighting specific zones or exhibitors of products. These are spaces where the kardan type spotlights are really common, and that is where this type of lightbulb is used.

A lâmpada AR111 FT-2718 da Filux é especialmente concebida para a iluminação de espaços interiores de uso comercial, como lojas, restaurantes e hotéis. Espaços onde a utilização de luminárias do tipo estas lâmpadas são habitualmente usadas em espaços que usam spotlight com kardan.



Ø110x67 mm

3  
YEAR  
WARRANTY

20.000H

CRI  
>80

36°

COB

IP20

G53

PF  
>0,9

LIFUD

40 PCS



Model	Sku	Power	C.Temp	Lumens	Input	€*
FT-2718	F2704	12W	4.000K	1.100	220V	32,40 €

\*Ecoraee incluida | included | incluída \* IVA no incluido | VAT not included | IVA não incluído

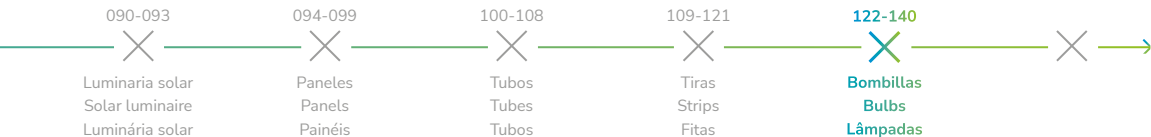

## R7S LED BULB

La bombilla LED FT-3811 R7S es el reemplazo de los antiguos halógenos lineales que podemos encontrar, por ejemplo en focos o lámparas de pie. De encendido instantáneo, sin parpadeos y mínima emisión de calor.

The LED bulb FT-3811 R7S is the replacement of the old linear halogens such as spotlights or floor lamps. The ignition is instantaneous, without flickers and minimum heat emission.

A lâmpada LED R7S FT-3811 permite a substituição lâmpadas antigas de halógeno lineares que podemos encontrar, por exemplo, em projectores ou candeeiros de pé. O acendimento é instantâneo, sem piscar e com emissão mínima de calor.

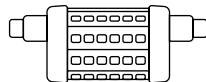

8W Ø29X78 mm  
14,5W Ø29X118 mm

**2**  
YEAR  
WARRANTY

**25.000H**

**CRI**  
>80

**330°**

**TRIAC**  
DIMMABLE

**IP20**

**R7S**

**PF**  
>0,9

**100 PCS**



Model	SKU	Power	C.Temp	Lumens	Input	€*
FT-3811	F3813	8,5W	2.700K	1.060	220-240V	13,61 €
	F3814		4.000K			
	F3815	15W	2.700K	2.000		18,31 €
	F3816		4.000K			

\*Ecoraee incluida | included | incluída \* IVA no incluido | VAT not included | IVA não incluído

020-031



Campanas  
High bays  
Campânulas

032-046



Farolas  
Streetlights  
Viárias

047-055



Proyectores  
Floodlights  
Pojetores

056-075



Downlights  
Downlights  
Downlights

076-084



Sensores  
Sensors  
Sensores

085-089



Lum. emergencia  
Emergency lum.  
Lum. emergência

## LED FITTINGS

Model	Sku	mm	Cutting size (mm)	Material	IP	Color	€*
-------	-----	----	-------------------	----------	----	-------	----

Corte

\*Ecoraee incluida | included | incluída \* IVA no incluido | VAT not included | IVA não incluído

FT-1500	F1550	Ø 90	Ø 70	Steel-Iron Acero-Hierro Aço-Ferro	54	○	3,32 €	
	F1551	87x87					3,53 €	
	F1552	Ø 90					3,32 €	
	F1553	87x87				9,77 €		
	F1555	Ø 92	Ø 88	Aluminio Aluminium Alumínio		○	8,88 €	
	F1556	89x89	84x84			9,38 €		
	F1557	Ø 85	Ø 75			9,77 €		
	F1558	85x85				9,77 €		
	F1554							0,53 €





**FILUX**  
BY FIT ENERGY

# Condiciones generales de venta y suministro de FIT Energy S.L. para europa

**GENERALIDADES:** Para la venta y suministro que realice FIT Energy, S.L. serán de aplicación las siguientes condiciones generales.

**OFERTAS:** Nuestras ofertas, bien escritas u orales, se entienden sin compromiso por nuestra parte, son sólo a título informativo, salvo que especialmente se pactara lo contrario, no significando en ningún caso compromiso de aceptación del pedido.

**PEDIDOS:** Son aceptados con la condición expresa de que queda reservado el derecho de modificar los precios y condiciones de venta por nuestra parte. En los casos de modificación de pedidos con suministros parciales, los clientes tendrán la facultad de anular las mercancías que quedaren pendientes de suministro, o bien aceptar el resto del pedido con las nuevas condiciones.

**PRECIOS:** Los precios se entienden por mercancías puestas en los Almacenes de FIT Energy, S.L. incluidos los embalajes normales (las dimensiones del embalaje de envío pueden variar dependiendo de la procedencia de la mercancía), siendo por cuenta del cliente cualquier protección o embalaje adicional. Franquicia de portes de 10 €, para pedidos con valor base mínimo de 300 € en península y de 1.000 € en Canarias, Baleares, Ceuta y Melilla, portes gratis.

Por su parte, los costes de envíos realizados a otros países de Europa deberán consultarse previamente a la finalización del proceso de compra ya que dependerán de diferentes condiciones, entre otras, el importe de la compra, lugar de envío, envío urgente, etc.

**SUMINISTROS:** Las mercancías viajan por cuenta y riesgo del comprador, aunque en los albaranes figuren portes pagados, con independencia del medio de transporte utilizado, cuya elección queda reservada a FIT Energy, S.L.

En caso de rotura, robo, avería, naufragio y extravío, el comprador o destinatario podrá reclamar al transportista, eximiendo a FIT Energy, S.L. de responsabilidad alguna en cuanto a la falta de material o al tiempo transcurrido en la expedición. El comprador asumirá los gastos que se produzcan en el transporte, siempre que, atendiendo a sus peticiones, éste se realizará por algún medio o agencia de transportes elegido por él mismo. FIT Energy, S.L. podrá realizar suministros y, consecuentemente, facturaciones parciales referidas a pedidos del comprador.

**PLAZOS:** Los plazos de entrega se consideran siempre aproximados y no podrá exigirse responsabilidad a causa de retrasos por fuerza mayor u otras circunstancias propias o ajenas a la voluntad de FIT Energy, S.L. no dando derecho al comprador a indemnizaciones ni anulaciones en los pagos por los pedidos realizados.

**PAGOS:** Salvo pacto en contrario, el pago se realizará en Vitoria-Gasteiz en las condiciones convenidas por ambas partes. En caso de demora en los pagos, se cargará al comprador el interés correspondiente, así como cualquier gasto de renovación o aplazamiento si lo hubiere. Queda reservada a FIT Energy, S.L. la facultad de fijar a cualquier

cliente el límite o cuantía máxima de crédito a conceder, así como suspender los suministros en el caso de tener el cliente pagos atrasados.

**DEVOLUCIONES DE MATERIAL:** No se admitirán devoluciones de material sin previa solicitud por parte del cliente y aprobación por parte de FIT Energy, S.L.

No se aceptará la devolución en los siguientes casos:

- a) Materiales que están descatalogados.
- b) Materiales que hayan sido usados con anterioridad a la devolución.
- c) Devoluciones en malas condiciones físicas, bien del material en sí o de los embalajes.
- d) Materiales no fabricados o comercializados por FIT Energy, S.L.
- e) Materiales cuyo suministro se realizó con anterioridad superior a seis meses a la fecha de la solicitud de devolución.
- f) Para realizar una propuesta de devolución es necesario indicar el número de factura o albarán del material que se pretende devolver.
- g) Salvo pacto en contrario, a la devolución se le aplicará un 5% de depreciación, FIT Energy, S.L. no se hará cargo de las devoluciones que no se remitan a portes pagados, resarciendo posteriormente al cliente, en los casos que proceda.

Siempre que el comprador acreditara devolver el material por defectos técnicos imputables al mismo, será necesario el dictamen o comprobación técnica del mismo, o de la instalación donde estuviere montado, por FIT Energy, S.L., que así lo confirme, en cuyo caso se resarcirá al comprador mediante abono o sustitución gratuita del material adquirido, sin que pueda exigirse daño o perjuicios de clase alguna.

**RECLAMACIONES:** FIT Energy, S.L., no aceptará reclamaciones relativas a errores en las cantidades o tipos recibidas por el cliente, siempre que no se realicen dentro de los 48 horas siguientes a la fecha en que se efectuó el suministro.

**VIARIOS:** Para cualquier divergencia que pudiera resultar en el cumplimiento e interpretación de las operaciones realizadas por FIT Energy, S.L. y su cliente, éste, con renuncia expresa de su propio fuero, o legislación, se somete expresamente a la jurisdicción de los Tribunales y Juzgados de Vitoria-Gasteiz. Estas condiciones derogan cualesquiera otras de fecha anterior a las mismas y permanecerán vigentes por tiempo indeterminado, en tanto no se establezcan otras nuevas con el mismo objeto.

\*Para consultar las condiciones generales completas de venta visitar la web: <http://ecommerce.fitenergy.es/contenido/condiciones-generales>.

# General conditions of sale and supply of FIT Energy S.L. for europe

**GENERAL:** For the sale and supply made by FIT Energy, S.L. the following general conditions will be applied.

**OFFERS:** Our offers, whether written or oral, are understood without commitment on our part, are only for information, unless otherwise agreed. That means, there is in no case commitment to accept the order.

**ORDERS:** They are accepted with the express condition that the right to modify the prices and conditions of sale by us is reserved. In cases of modification of orders with partial supplies, customers will have the power to cancel the goods that remain pending supply, or accept the rest of the order with the new conditions.

**PRICES:** The prices are understood by merchandise placed in the Warehouses of FIT Energy, S.L. including normal packaging (the dimensions of the shipping carton may vary depending on the origin of the goods), being the customer's account any additional protection or packaging. Freight charge of € 10, for orders with a minimum base value of 300 € in the peninsula and 1.000 € in the Canary Islands, Balearic Islands, Ceuta and Melilla, free of charge.

Moreover, the shipping costs to other European countries should be previously consulted at the end of the purchase process, because they will depend on various conditions, e.g., the amount of the purchase, place of delivery, express delivery, etc.

**SUPPLIES:** The goods travel at the buyer's risk and expense, even if the delivery notes are paid freight, regardless of the means of transport used, whose choice is reserved for FIT Energy, S.L. In case of breakage, theft, damage, wreckage and loss, the buyer or recipient can claim the carrier, exempting FIT Energy, S.L. of any responsibility regarding the lack of material or the time elapsed in the expedition. The buyer will assume the expenses that occur in the transportation, provided that, according to his requests, this will be done by some means or transport agency chosen by him. FIT Energy, S.L. may make supplies and, consequently, partial invoices referred to buyer's orders.

**DEADLINES:** The delivery times are always considered approximate and no liability can be demanded due to delays due to force majeure or other circumstances of their own or outside the will of FIT Energy, S.L. not giving the buyer the right to compensations or cancellations in the payments for the orders placed.

**PAYMENTS:** Unless otherwise agreed, payment shall be made in Vitoria-Gasteiz under the conditions agreed by both parties. In case of delay in payments, the buyer will be charged the corresponding interest, as well as any expenses of renewal or postponement if any. Reserved for FIT Energy, S.L. the power to set any client the limit or maximum amount of credit to be granted, as well as suspend the supplies in case the customer has late payments.

**RETURNS OF MATERIAL:** No refunds of material will be accepted without prior request from the customer and approval by FIT Energy, S.L. The refund will be not accepted in the following cases:

- a) Materials that are discontinued.
- b) Materials that have been used prior to the return.
- c) Returns in bad physical condition, either of the material itself or of the packaging.
- d) Materials not manufactured or marketed by FIT Energy, S.L.
- e) Materials whose supply was made earlier than six months prior to the date of the return request.
- f) To make a return proposal it is necessary to indicate the invoice number or delivery note of the material to be returned.
- g) Unless otherwise agreed, a 5% depreciation will be applied to the return, FIT Energy, S.L. will be not responsible for returns that are not shipped paid, subsequently recouping the client, in appropriate cases.

Whenever the buyer proves to return the material for technical defects imputable to the products, it will be necessary the opinion or technical verification of the products, or of the installation where they are installed, by FIT Energy, S.L. that confirms it, in that case purchaser will be compensated by free substituting or replacing the purchased material, without any damages or damages of any kind.

**CLAIMS:** FIT Energy, S.L., will not accept claims regarding errors in the quantities or types received by the customer, provided that they are not made within 48 hours following the date on which the supply was made.

**VARIOUS:** For any divergence that could result in the compliance and interpretation of the operations carried out by FIT Energy, S.L. and his client, expressly waiving his or her own jurisdiction, or legislation, is expressly subject to the jurisdiction of the Tribunals and Courts of Vitoria-Gasteiz. These conditions will abrogate any others dated prior to them and will remain in force indefinitely, as long as other new ones with the same object are not established.

\* To consult the general conditions of sale visit the web: <http://ecommerce.fitenergy.es/contenido/condiciones-generales>.

# Condições gerais de venda e fornecimento da FIT Energy S.L. para a europa

**GERAL:** Para a venda e fornecimento da FIT Energy, S.L. aplicam-se as seguintes condições gerais.

**PROPOSTAS:** As nossas propostas, sejam escritas ou verbais, são entendidas sem compromisso de nossa parte, são apenas para fins informativos, salvo acordo especial em contrário, o que significa, que em nenhum caso, compromisso para aceitar a encomenda.

**ENCOMENDAS:** Elas são aceites com a condição expressa de que o direito de modificar os preços e condições de venda são reservadas a FIT Energy, S.L. Nos casos de modificação de encomendas com suprimentos parciais, os clientes terão o direito de cancelar os produtos que estejam pendentes de fornecimento ou aceitar o restante da encomenda com as novas condições.

**PREÇOS:** Os preços são entendidos como produtos colocadas nos armazéns da FIT Energy, S.L. incluem embalagem normal (as dimensões da embalagem podem variar dependendo da origem do produto), com qualquer proteção adicional ou embalagem sendo paga pelo cliente. Valor de portes de envio de 10€, para encomendas com um valor inferior a 300€.

Os custos de envio de productos enviados para outros países europeus devem ser consultados antes da conclusão do processo de compra, uma vez que dependerão de condições diferentes, entre outros, o valor da compra, local de entrega, entrega urgente, etc.

**FORNECIMENTOS:** As mercadorias viajam por conta e risco do comprador, embora as notas de remessa incluam o porte pago, independentemente do meio de transporte utilizado, cuja escolha está reservada à FIT Energy, S.L.

Em caso de quebra, roubo, avaria, naufrágio e perda, o comprador ou destinatário pode reclamar à transportadora, ficando a FIT Energy, S.L. isenta de qualquer responsabilidade em relação à falta de material ou o tempo decorrido na expedição. O comprador assumirá as despesas que ocorrerem no transporte, desde que, de acordo com seus pedidos, este seja realizado por qualquer meio ou agência de transporte escolhida por ele. FIT Energy, S.L. pode fazer fornecimentos e, consequentemente, faturas parciais referiam-se a ordens do comprador.

**PRAZOS:** Os prazos de entrega são sempre considerados aproximados e nenhuma responsabilidade pode vir a ser exigida pelos atrasos devido a força maior ou outras circunstâncias próprias ou fora do controle da FIT Energy, S.L. não dando ao comprador o direito de compensação ou cancelamento de pagamentos por pedidos efetuados.

**PAGAMENTOS:** Salvo acordo em contrário, o pagamento será feito em vitoria-gasteiz, nas condições acordadas por ambas as partes. Em caso de atraso nos pagamentos, ao comprador será cobrado os juros correspondentes, bem como quaisquer despesas de renovação ou adiamento, se houver. É reservado para a FIT Energy, S.L. o poder definir a qualquer cliente o limite do montante máximo de crédito concedido, bem como suspender os fornecimentos no caso de o cliente ter atrasos nos pagamentos.

**DEVOLUÇÕES DO MATERIAL:** Reembolsos de material não serão aceites sem solicitação prévia do cliente e aprovação por escrito pela FIT Energy, S.L. o retorno não será aceito nos seguintes casos:

- a) Materiais descontinuados.
- b) Materiais que foram usados antes do retorno.
- c) Retorna em más condições físicas, seja do próprio material ou da embalagem.
- d) Materiais não fabricados ou comercializados pela FIT Energy, S.L.
- e) Materiais cujo fornecimento foi feito á mais de seis meses antes da data do pedido de devolução.
- f) Para fazer uma proposta de devolução, é necessário indicar o número da fatura ou nota de remessa do material que deve ser devolvido.
- g) Salvo acordo em contrário, será aplicada uma depreciação de 5% ao retorno, a FIT Energy, S.L. não será responsável por devoluções que não sejam enviadas em frete pago, subseqüentemente reembolsando o cliente, nos casos apropriados.

Sempre que o comprador creditado para retornar o material atribuível aos mesmos defeitos técnicos, a opinião ou a sua monitorização, ou a instalação onde a pessoa foi montado pela FIT Energy, S.L. que eles confirmam, caso em que será necessário reembolsar o comprador por pagamento ou substituição gratuita do material adquirido, sem qualquer dano ou prejuízo de qualquer espécie pode ser exigido.

**REIVINDICAÇÕES:** a FIT Energy, S.L., não aceitará reclamações relativas a erros nos valores ou tipos recebidos pelo cliente, desde que não sejam feitas dentro de 48 horas após a data em que o fornecimento foi feito.

**DIVERSOS:** Para qualquer divergência que possa resultar em conformidade e interpretação das operações realizadas pela FIT Energy, S.L. e seu cliente, que renuncia expressamente à sua própria jurisdição ou legislação, se submete expressamente à jurisdição dos tribunais de vitoria-gasteiz. Estas condições revogarão quaisquer outras datas anteriores e permanecerão em vigor por um período indefinido, desde que não sejam estabelecidas novas para o mesmo fim.

\*Para consultar as condições gerais de venda visite a web: <http://ecommerce.fitenergy.es/contenido/condiciones-generales>.



# SKU

\*Ecoraee inclusa | included | incluida \* IVA no incluido | VAT not included | IVA não incluído

F1010	FT-1007	4,67 €	p. 135	F1518	FT-1505	8,39 €	p. 125	F1808	FT-1807	4,82 €	p. 130
F1013	FT-1000	0,50 €	p. 102	F1519	FT-1505	10,35 €	p. 124	F1809	FT-1807	4,82 €	p. 130
F1026	FT-1009	8,23 €	p. 102	F1520	FT-1505	10,35 €	p. 124	F1904	FT-1904	2,57 €	p. 131
F1027	FT-1009	8,23 €	p. 102	F1521	FT-1505	10,78 €	p. 124	F1905	FT-1904	2,57 €	p. 131
F1028	FT-1009	8,23 €	p. 102	F1522	FT-1505	10,78 €	p. 124	F1906	FT-1904	2,57 €	p. 131
F1029	FT-1014	9,21 €	p. 102	F1550	FT-1500	3,32 €	p. 140	F1907	FT-1907	3,30 €	p. 131
F1030	FT-1014	9,21 €	p. 102	F1551	FT-1500	3,53 €	p. 140	F1908	FT-1907	3,30 €	p. 131
F1031	FT-1014	9,21 €	p. 102	F1552	FT-1500	3,32 €	p. 140	F1909	FT-1907	3,30 €	p. 131
F1032	FT-1018	11,46 €	p. 102	F1553	FT-1500	3,53 €	p. 140	F2000	FT-2000	46,20 €	p. 55
F1033	FT-1018	11,46 €	p. 102	F1554	FT-1500	0,53 €	p. 140	F2051	FT-2000	4,72 €	p. 28
F1034	FT-1018	11,46 €	p. 102	F1555	FT-1500	8,88 €	p. 140	F2052	FT-2000	13,15 €	p. 38
F1035	FT-1022	13,92 €	p. 102	F1556	FT-1500	9,38 €	p. 140	F2053	FT-2000	1,14 €	p. 59
F1036	FT-1022	13,92 €	p. 102	F1557	FT-1500	9,77 €	p. 140	F2121	FT-2120	19,21 €	p. 107
F1037	FT-1022	13,92 €	p. 102	F1558	FT-1500	9,77 €	p. 140	F2122	FT-2120	19,21 €	p. 107
F1139	FT-1120	57,61 €	p. 104	F1601	FT-1605	3,01 €	p. 128	F2124	FT-21050	50,32 €	p. 55
F1140	FT-1140	81,00 €	p. 104	F1602	FT-1605	3,01 €	p. 128	F2125	FT-21015	24,92 €	p. 52
F1141	FT-1150	106,31 €	p. 104	F1603	FT-1605	3,01 €	p. 128	F2126	FT-21015	24,92 €	p. 52
F1144	FT-1120	26,87 €	p. 105	F1623	FT-3515	9,06 €	p. 129	F2127	FT-21015	24,92 €	p. 52
F1145	FT-1140	42,41 €	p. 105	F1624	FT-3515	9,05 €	p. 129	F2128	FT-21030	28,89 €	p. 52
F1146	FT-1150	50,82 €	p. 105	F1625	FT-3515	9,06 €	p. 129	F2129	FT-21030	28,89 €	p. 52
F1147	FT-1104	11,97 €	p. 108	F1626	FT-1420	11,77 €	p. 133	F2130	FT-21030	28,89 €	p. 52
F1148	FT-1104	11,97 €	p. 108	F1627	FT-1420	11,77 €	p. 133	F2131	FT-21050	43,01 €	p. 53
F1149	FT-1108	14,13 €	p. 108	F1628	FT-1420	11,77 €	p. 133	F2132	FT-21050	43,01 €	p. 53
F1150	FT-1108	14,13 €	p. 108	F1632	FT-1608	5,52 €	p. 134	F2133	FT-21050	43,01 €	p. 53
F1151	FT-1116	19,63 €	p. 108	F1633	FT-1610	3,49 €	p. 128	F2134	FT-21100	69,62 €	p. 53
F1152	FT-1116	19,63 €	p. 108	F1634	FT-1610	3,49 €	p. 128	F2135	FT-21100	69,62 €	p. 53
F1301	FT-1306	3,88 €	p. 127	F1635	FT-1610	3,49 €	p. 128	F2136	FT-21100	69,62 €	p. 53
F1302	FT-1306	3,88 €	p. 127	F1636	FT-1612	4,22 €	p. 128	F2137	FT-21150	134,64 €	p. 53
F1303	FT-1306	3,88 €	p. 127	F1637	FT-1612	4,22 €	p. 128	F2138	FT-21150	134,66 €	p. 53
F1504	FT-1504	2,98 €	p. 127	F1638	FT-1612	4,22 €	p. 128	F2139	FT-21150	134,66 €	p. 53
F1505	FT-1504	2,98 €	p. 127	F1639	FT-1616	5,40 €	p. 128	F2140	FT-21200	171,29 €	p. 53
F1506	FT-1504	2,98 €	p. 127	F1640	FT-1616	5,40 €	p. 128	F2141	FT-2140	31,97 €	p. 107
F1510	FT-1505	2,84 €	p. 133	F1641	FT-1616	5,40 €	p. 128	F2142	FT-2140	31,97 €	p. 107
F1511	FT-1505	2,84 €	p. 133	F1704	FT-1704	2,55 €	p. 132	F2143	FT-21200	171,29 €	p. 53
F1512	FT-1505	2,84 €	p. 133	F1705	FT-1704	2,55 €	p. 132	F2144	FT-21200	171,29 €	p. 53
F1513	FT-1507	3,89 €	p. 126	F1706	FT-1704	2,55 €	p. 132	F2145	FT-21250	227,99 €	p. 53
F1514	FT-1507	3,89 €	p. 126	F1707	FT-1707	3,52 €	p. 136	F2146	FT-21250	227,99 €	p. 53
F1515	FT-1507	3,89 €	p. 126	F1708	FT-1707	3,53 €	p. 132	F2147	FT-21250	227,99 €	p. 53
F1516	FT-1505	8,39 €	p. 125	F1709	FT-1707	3,53 €	p. 132	F2151	FT-2150	39,59 €	p. 107
F1517	FT-1505	8,39 €	p. 125	F1807	FT-1807	4,82 €	p. 130	F2152	FT-2150	39,59 €	p. 107

F2704	FT-2718	32,40 €	p. 138	F2883	FT-2801	22,69 €	p. 115	F4722	FT-4720	364,55 €	p. 30
F2814	FT-2802	24,05 €	p. 121	F2884	FT-2801	14,35 €	p. 115	F5013	FT-5009	30,07 €	p. 103
F2815	FT-2802	23,26 €	p. 121	F2885	FT-2801	14,35 €	p. 115	F5014	FT-5009	30,07 €	p. 103
F2816	FT-2802	20,19 €	p. 121	F2886	FT-2801	16,43 €	p. 116	F5015	FT-5009	30,07 €	p. 103
F2821	FT-2820	37,77 €	p. 113	F2887	FT-2801	58,92 €	p. 117	F5016	FT-5012	38,01 €	p. 103
F2822	FT-2820	37,77 €	p. 113	F2888	FT-2801	42,22 €	p. 117	F5017	FT-5012	38,01 €	p. 103
F2823	FT-2820	37,77 €	p. 113	F2889	FT-2801	20,50 €	p. 118	F5018	FT-5012	38,01 €	p. 103
F2840	FT-2042	117,33 €	p. 112	F2890	FT-2801	28,79 €	p. 119	F5019	FT-5020	47,17 €	p. 103
F2841	FT-2042	117,33 €	p. 112	F2891	FT-2801	28,79 €	p. 118	F5020	FT-5020	47,17 €	p. 103
F2842	FT-2042	117,33 €	p. 112	F2892	FT-2801	47,16 €	p. 119	F5021	FT-5020	47,17 €	p. 103
F2843	FT-2122	159,21 €	p. 112	F2893	FT-2801	46,11 €	p. 120	F5022	FT-5025	54,48 €	p. 103
F2844	FT-2122	159,21 €	p. 112	F2894	FT-2801	83,14 €	p. 120	F5023	FT-5025	54,48 €	p. 103
F2845	FT-2122	159,21 €	p. 112	F3012	FT-3000	213,84 €	p. 42	F5024	FT-5025	54,48 €	p. 103
F2846	FT-2192	171,16 €	p. 112	F3013	FT-3000	22,68 €	p. 42	F5101	FT-5106	20,37 €	p. 106
F2847	FT-2192	171,16 €	p. 112	F3014	FT-3000	129,60 €	p. 42	F5102	FT-5112	32,76 €	p. 106
F2848	FT-2192	171,16 €	p. 112	F3015	FT-3000	28,09 €	p. 24	F5103	FT-5115	40,02 €	p. 106
F2849	FT-2046	166,65 €	p. 112	F3305	FT-3350	75,37 €	p. 46	F5144	FT-5140	223,92 €	p. 40
F2850	FT-2046	166,65 €	p. 112	F3341	FT-33100	115,44 €	p. 34	F5201	FT-5206	24,65 €	p. 106
F2851	FT-2046	166,65 €	p. 112	F3342	FT-33100	170,83 €	p. 34	F5202	FT-5212	42,04 €	p. 106
F2852	FT-2126	207,65 €	p. 112	F3343	FT-33100	253,82 €	p. 34	F5203	FT-5215	52,00 €	p. 106
F2853	FT-2126	207,65 €	p. 112	F3344	FT-33100	132,12 €	p. 42	F5244	FT-5240	348,18 €	p. 39
F2854	FT-2126	207,65 €	p. 112	F3345	FT-33100	132,12 €	p. 42	F5245	FT-5250	535,81 €	p. 40
F2855	FT-2196	223,63 €	p. 112	F3346	FT-33100	25,07 €	p. 36	F5270	FT-5001	33,74 €	p. 92
F2856	FT-2196	223,63 €	p. 112	F3347	FT-33100	2,52 €	p. 36	F5271	FT-5001	33,74 €	p. 92
F2857	FT-2196	223,63 €	p. 112	F3348	FT-33100	228,79 €	p. 37	F5272	FT-5002	386,38 €	p. 93
F2858	FT-2815	25,88 €	p. 110	F3349	FT-33100	2.855,16 €	p. 37	F6010	FT-6000	44,21 €	p. 28
F2859	FT-2815	25,88 €	p. 110	F3350	FT-33100	4.538,11 €	p. 37	F6011	FT-6000	123,77 €	p. 24
F2860	FT-2815	25,88 €	p. 110	F3404	FT-3445	8,31 €	p. 43	F6018	FT-6100	273,03 €	p. 22
F2864	FT-2830	5,07 €	p. 111	F3411	FT-3420	29,48 €	p. 43	F6019	FT-6150	308,13 €	p. 22
F2865	FT-2804	14,21 €	p. 114	F3412	FT-3420	29,48 €	p. 43	F6020	FT-6200	378,26 €	p. 22
F2866	FT-2804	18,13 €	p. 114	F3413	FT-3420	29,48 €	p. 43	F6021	FT-6300	539,15 €	p. 22
F2867	FT-2804	25,60 €	p. 114	F3414	FT-3440	36,73 €	p. 43	F6027	FT-6000	16,67 €	p. 24
F2868	FT-2804	34,94 €	p. 114	F3415	FT-3440	36,73 €	p. 43	F6028	FT-6000	10,21 €	p. 24
F2869	FT-2804	38,01 €	p. 114	F3416	FT-3440	36,73 €	p. 43	F6029	FT-6000	10,21 €	p. 24
F2870	FT-2804	27,97 €	p. 114	F3701	FT-3725	3,84 €	p. 136	F6031	FT-6000	436,55 €	p. 89
F2871	FT-2804	43,62 €	p. 114	F3702	FT-3725	3,84 €	p. 136	F6032	FT-6000	61,88 €	p. 24
F2872	FT-2804	54,02 €	p. 114	F3703	FT-3725	3,84 €	p. 136	F6043	FT-6100	198,15 €	p. 26
F2873	FT-2804	73,81 €	p. 114	F3704	FT-3726	3,84 €	p. 137	F6044	FT-6150	211,48 €	p. 26
F2874	FT-2815	26,30 €	p. 110	F3705	FT-3726	3,84 €	p. 137	F6045	FT-6200	254,29 €	p. 26
F2875	FT-2830	115,87 €	p. 111	F3706	FT-3726	3,84 €	p. 137	F6046	FT-6000	16,67 €	p. 28
F2876	FT-2830	6,40 €	p. 111	F3813	FT-3811	13,61 €	p. 139	F6047	FT-6000	10,21 €	p. 28
F2878	FT-2801	64,59 €	p. 114	F3814	FT-3811	13,61 €	p. 139	F6048	FT-6000	10,21 €	p. 28
F2879	FT-2801	20,51 €	p. 114	F3815	FT-3811	18,31 €	p. 139	F6049	FT-6000	16,67 €	p. 28
F2880	FT-2801	36,93 €	p. 114	F3816	FT-3811	18,31 €	p. 139	F6050	FT-6000	10,21 €	p. 28
F2881	FT-2801	46,68 €	p. 114	F4720	FT-4710	251,09 €	p. 30	F6051	FT-6000	10,21 €	p. 28
F2882	FT-2801	47,72 €	p. 114	F4721	FT-4715	315,60 €	p. 30	F6513	FT-6000	86,95 €	p. 24

F7010	FT-7000	32,73 €	p. 86	F9008	FT-9018	11,65 €	p. 64	F9203	FT-9230	38,34 €	p. 75
F7011	FT-7000	6,70 €	p.86	F9009	FT-9018	11,65 €	p. 64	F9204	FT-9240	17,65 €	p. 80
F7012	FT-7000	15,85 €	p. 86	F9010	FT-9024	19,15 €	p. 64	F9205	FT-9240	17,65 €	p. 80
F7013	FT-7000	55,24 €	p. 87	F9011	FT-9024	19,15 €	p. 64	F9206	FT-9240	17,35 €	p. 81
F7014	FT-7000	7,69 €	p. 87	F9012	FT-9024	19,15 €	p. 64	F9207	FT-9240	19,14 €	p. 82
F7015	FT-7000	5,16 €	p. 87	F9061	FT-9001	5,06 €	p. 61	F9208	FT-9240	17,10 €	p. 83
F7016	FT-7000	21,24 €	p. 87	F9062	FT-9001	7,59 €	p. 61	F9209	FT-9240	16,18 €	p. 84
F7017	FT-7000	0,80 €	p. 86	F9063	FT-9001	9,23 €	p. 61	F9210	FT-9230	30,51 €	p. 74
F7018	FT-7000	1,34 €	p. 86	F9064	FT-9001	9,53 €	p. 61				
F7019	FT-7000	186,43 €	p. 88	F9065	FT-9001	6,12 €	p. 63				
F7020	FT-7000	46,69 €	p. 88	F9066	FT-9001	8,36 €	p. 63				
F8007	FT-8000	28,31 €	p. 96	F9067	FT-9001	10,71 €	p. 63				
F8008	FT-8000	37,55 €	p. 97	F9068	FT-9008	13,08 €	p. 60				
F8009	FT-8000	12,35 €	p. 96	F9069	FT-9015	18,40 €	p. 60				
F8013	FT-8000	19,27 €	p. 97	F9070	FT-9020	25,35 €	p. 60				
F8014	FT-8000	48,57 €	p. 98	F9071	FT-9025	30,22 €	p. 60				
F8019	FT-8000	14,68 €	p. 96	F9072	FT-9008	12,04 €	p. 62				
F8021	FT-8000	96,53 €	p. 96	F9073	FT-9015	17,24 €	p. 62				
F8028	FT-8600	54,02 €	p. 99	F9074	FT-9020	25,37 €	p. 62				
F8029	FT-8600	54,02 €	p. 99	F9075	FT-9005	17,50 €	p. 58				
F8030	FT-8000	32,86 €	p. 96	F9076	FT-9005	5,03 €	p. 59				
F8031	FT-8000	40,22 €	p. 97	F9077	FT-9005	4,24 €	p. 59				
F8040	FT-8600	81,53 €	p. 96	F9078	FT-9005	32,63 €	p. 58				
F8041	FT-8600	81,53 €	p. 96	F9079	FT-9005	6,84 €	p. 59				
F8042	FT-8123	93,63 €	p. 99	F9080	FT-9005	5,87 €	p. 59				
F8043	FT-8123	93,63 €	p. 97	F9081	FT-9005	59,32 €	p. 58				
F8044	FT-8126	154,79 €	p. 98	F9082	FT-9005	8,82 €	p. 59				
F8045	FT-8126	154,79 €	p. 98	F9083	FT-9005	8,04 €	p. 59				
F8046	FT-8000	15,68 €	p. 96	F9084	FT-9038	122,34 €	p. 66				
F8047	FT-8000	38,57 €	p. 98	F9085	FT-9038	126,64 €	p. 67				
F8510	FT-8500	470,87 €	p. 48	F9086	FT-9015	24,51 €	p. 68				
F8511	FT-8500	167,48 €	p. 48	F9087	FT-9015	24,51 €	p. 68				
F8512	FT-8500	357,58 €	p. 48	F9088	FT-9015	24,51 €	p. 68				
F8513	FT-8500	454,64 €	p. 48	F9089	FT-9015	24,51 €	p. 68				
F8514	FT-8500	544,08 €	p. 48	F9090	FT-9015	25,11 €	p. 69				
F8515	FT-8500	32,13 €	p. 50	F9091	FT-9015	25,11 €	p. 69				
F8516	FT-8500	32,13 €	p. 50	F9092	FT-9015	25,11 €	p. 69				
F8517	FT-8500	32,13 €	p. 50	F9093	FT-9015	25,11 €	p. 69				
F8518	FT-8500	31,66 €	p. 50	F9094	FT-9015	29,47 €	p. 70				
F9001	FT-9006	6,80 €	p. 64	F9095	FT-9015	29,47 €	p. 70				
F9002	FT-9006	6,80 €	p. 64	F9096	FT-9015	18,37 €	p. 72				
F9003	FT-9006	6,80 €	p. 64	F9097	FT-9015	18,37 €	p. 72				
F9004	FT-9012	9,11 €	p. 64	F9098	FT-9015	68,00 €	p. 71				
F9005	FT-9012	9,11 €	p. 64	F9099	FT-9015	68,00 €	p. 71				
F9006	FT-9012	9,11 €	p. 64	F9201	FT-9210	17,56 €	p. 78				
F9007	FT-9018	11,65 €	p. 64	F9202	FT-9220	18,70 €	p. 79				

# FILUX

ILUMINACIÓN LED PROFESIONAL

[WWW.FILUX.ES](http://WWW.FILUX.ES)

GRANDES DESCUENTOS

BIG DISCOUNTS

GRANDES DESCONTOS

FILUX ES UNA MARCA DE



Portal de Zurbano, 13  
01013 Vitoria-Gasteiz, España.  
+34 945 292 773  
[fitenergy.es](http://fitenergy.es)